

Defluoridation of Drinking Water and Rainwater Harvesting Using a Solar Still

L. Anjaneyulu,[†] E. Arun Kumar,[‡] Ravi Sankannavar, and K. Kesava Rao*

Department of Chemical Engineering, Indian Institute of Science, Bangalore 560012, India

ABSTRACT: When people drink water having a fluoride (F^-) concentration >1 – 1.5 mg/L for a long period of time, various ailments that are collectively referred to as fluorosis occur. Based on the design of Thomas (<http://www.planetkerala.org>), an inclined basin-type solar still containing sand and water has been used at Bangalore for defluoridation. For water samples having a fluoride concentration in the range 5 – 20 mg/L, the fluoride concentration in the distillate was usually <1.5 mg/L. During the periods October 2006–May 2007 and October 2007–May 2008, the volume of distillate showed a significant diurnal variation, ranging from 0.3 to 4.0 L/m²·day. Based on the figures for 2006, the cost of the still was about Rs. 850 (US\$16) for collector areas in the range 0.50 – 0.57 m². The occurrence of F^- in the distillate merits further investigation. Overall, the still effectively removes F^- , but a large area of the collector, in the range 2.5 – 25 m², is needed to produce about 10 L of distilled water for cooking and drinking. Rainwater falling on the upper surface of the still was collected, and its fluoride concentration was found to be below the desirable limit of 1 mg/L. Hence it can also be used for cooking and drinking.

■ INTRODUCTION

As per Indian Standards, the desirable limit for the concentration of fluoride in drinking water c_F is 1 mg/L.¹ In the absence of alternative sources, the limit may be relaxed to 1.5 mg/L, which is also the permissible limit prescribed by the World Health Organization.² Prolonged consumption by people of water containing excess F^- leads to various ailments that are collectively referred to as “fluorosis”.

In India, the first cases of fluorosis were reported by Shortt et al.³ (cited in Shortt et al.⁴). Since then, a large number of papers have been published on defluoridation or the removal of fluoride, but the problem of fluorosis persists. Based on current estimates,⁵ millions of people from over 35 countries drink water containing excess fluoride, and hence may be prone to fluorosis. The suffering of the affected people provides a strong motivation for work on defluoridation. For example, a villager from Jharana Khurd in the state of Rajasthan, India, stated,⁶ “Our shoulders, hips, and ankles are swollen all the time. If we squat on the floor, it is painful to stand up.”

The present work deals with experiments on the use of solar distillation for defluoridation. In contrast to several works on its use for desalination of seawater and brackish water,^{7–13} studies on its use for defluoridation have been reported only recently.^{14–17} A more general study¹⁸ used various feed waters, each containing either F^- , nitrate, pesticides, or bacteria, and examined the concentration of these contaminants in the distillate. This paper is largely based on the work of Anjaneyulu¹⁴ and Kumar.¹⁵

The fluoride concentration c_F in the water samples used by Sahoo et al.¹⁶ was well below the desirable limit of 1 mg/L. Hence, their work did not show that water containing a high concentration of fluoride could be treated using solar stills. The latter result was shown by the experiments of Antwi et al.,¹⁷ who used a feed water with $c_F = 20.65$ mg/L and found that the concentration of F^- in the distillate was around 0.76 mg/L.

However, data were reported only for a period of 5 days, and the volume of the distillate was not reported.

The present work complements the work of Hanson et al.¹⁸ and Antwi et al.,¹⁷ as data have been reported for a longer period of time (16 months), using stills of a different design, and operating under different climatic conditions with a wider range of feed concentrations of F^- . Further, the variation of the volume of the distillate with the day of operation has not been reported by Hanson et al.¹⁸ However, in contrast to their work, only one contaminant, namely F^- , has been considered here.

Some preliminary work on rainwater harvesting is also reported.

■ EXPERIMENTAL DETAILS

Based on the design of Thomas,¹⁹ an aluminum tray partly filled with a layer of sand and covered with a glass plate was used as an inclined basin-type solar still (Figure 1).

The glass plate permits the incident short-wave solar radiation to pass through but traps the long-wave radiation emitted by the sand and water in the still. Absorption of radiation by the water raises its temperature, and hence the rate of evaporation increases. The water vapor condenses on the inner surface of the plate and is collected using a channel.

Thomas¹⁹ used stills of this type to produce potable water from brackish water and did not study its performance for defluoridation.

The production of distilled water from a still containing wet sand or soil is referred to as earth–water distillation.²⁰ It can be used to extract water from the soil in arid regions.²¹ In the present work, the sand permits the inclined still to retain a layer of water. In the absence of the sand, the feed water will

Received: August 1, 2011

Revised: May 10, 2012

Accepted: May 16, 2012

Published: May 16, 2012

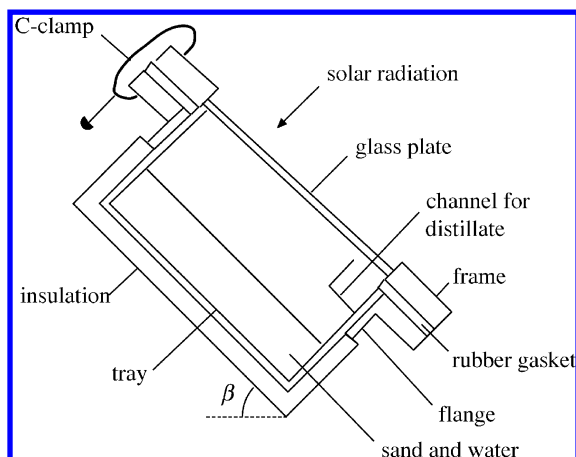

Figure 1. Sketch of an inclined basin-type solar still.

overflow if the height of its free surface exceeds that of the channel used to collect the distillate (Figure 1).

Two stills having the dimensions $0.875 \text{ m} \times 0.568 \text{ m} \times 0.050 \text{ m}$ (still 1) and $0.923 \text{ m} \times 0.619 \text{ m} \times 0.050 \text{ m}$ (still 2) and collector areas of 0.50 and 0.57 m^2 were fabricated. A flange with a rubber gasket stuck on its upper surface was fixed to the tray (Figure 1). A glass plate of 5 mm thickness was mounted in an aluminum frame that was tightly clamped to the flange using C-clamps. The still had an inlet for feeding the water and a channel for collecting the distillate (Figure 2). At the lower end

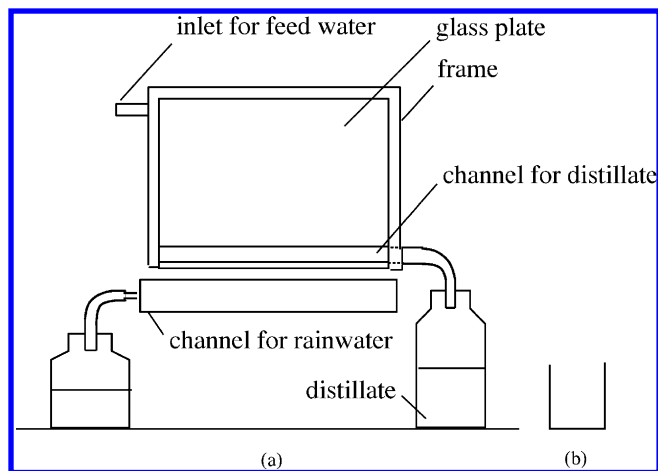

Figure 2. (a) Elevation of the still; (b) cross section of the distillate channel.

of the still, a plastic pipe of semicircular cross section was attached to collect the rainwater incident on the upper surface of the glass plate, as suggested by Thomas¹⁹ (Figure 2). The stills were placed adjacent to each other on the terrace of our department at Bangalore (13° N , 77° E). Experiments were conducted from October 2006 to May 2007, from October 2007 to May 2008, and from October 2011 to November 2011.

The orientation of the still is fixed by specifying its slope or inclination β to the horizontal (Figures 1 and 3) and the surface azimuth angle γ (Figure 3). The latter is the angle measured clockwise from the line due south and the projection of the outward normal to the upper surface of the still onto the horizontal plane.²²

Let us briefly discuss the choices of β and γ for a location such as Bangalore, which is in the Northern Hemisphere.

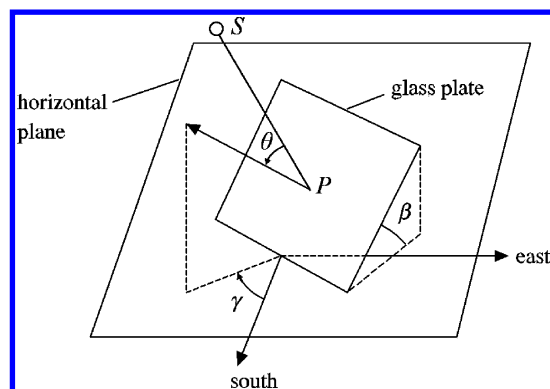

Figure 3. Orientation of the still. The angle β is the inclination of the base of the still to the horizontal, and the angle γ is the angle between the line due south and the projection of the outward normal to the glass plate onto the horizontal plane. Here θ is the angle between the outward normal at P to the plate and the line joining P to the sun S .

Suppose that the declination $\delta < 0$; i.e., the line joining the sun to the center of the earth lies below the equatorial plane. During this period (September 23 to March 20), the path of the sun, as seen by an observer on the ground, lies in a plane that is due south of the observer.²² Conversely, if $\delta > 0$ (March 22 to September 21), the path lies in a plane that is due north of the observer. Hence we set $\gamma = 0^\circ$ (surface facing due south) from October to March and $\gamma = 180^\circ$ (surface facing due north) from April to May.

By varying β to maximize the monthly average of the daily solar radiation incident on the inclined surface (see the Appendix), it was found that the optimum values of β were 23° (October), 30° (November), 38° (December), 44° (January), 32° (February), 17° (March), 2° (April), and 14° (May).¹⁴ Very low values of β , such as 2° for April, are impractical as the condensate tends to fall back into the tray instead of flowing toward the distillate channel. Perusal of our laboratory notebooks shows that the actual values of β used in the experiments, denoted by β_a , were inexplicably quite different from the calculated values cited above. The values of β_a were 10° for October 2006 and 15° for November and December 2006. For the other months, the values of β_a were inadvertently not recorded.

A known amount of NaF was dissolved in either tap water (October 2006–May 2007) or deionized water (October 2007–May 2008) and fed to the still. The inlet was then closed with a plug and the distillate was collected in a bottle (Figure 2). The concentration of fluoride in the distillate c_d was estimated using a spectrophotometric method.²³ Henceforth, unless otherwise stated, all values of c_d denote the mean values obtained from the calibration curve. The 95% confidence limits are given approximately by $c_d \pm 0.3 \text{ mg/L}$.

RESULTS

Solar Distillation (October 2006–May 2007). The volume of the distillate V_d varied widely, from 0.6 – $0.7 \text{ L/m}^2\text{-day}$ in October to 3.4 – $3.7 \text{ L/m}^2\text{-day}$ during April and May, as shown by the circles in Figure 4. As expected, the output was less in the winter months.

When the feed had a fluoride concentration $c_f = 5 \text{ mg/L}$, the fluoride concentration in the distillate, c_d , was below the detection limit of 0.3 mg/L , as indicated by the circles in Figure 5.

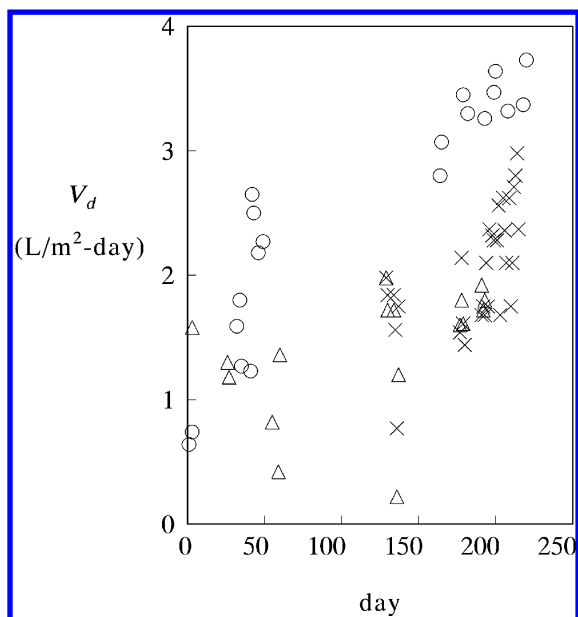

Figure 4. Variation of the volume of distillate, V_d , with the day of operation: \circ , still 2, October 2006–May 2007; \triangle , still 1, \times , still 2, October 2007–May 2008; day 1 = Oct 14. As the year 2008 was a leap year, day 139 corresponds to March 1, 2007 and Feb 29, 2008. For the ordinates, a “day” corresponds to approximately 24 h during the period October 2006–May 2007 and approximately 7 h during the period October 2007–May 2008.

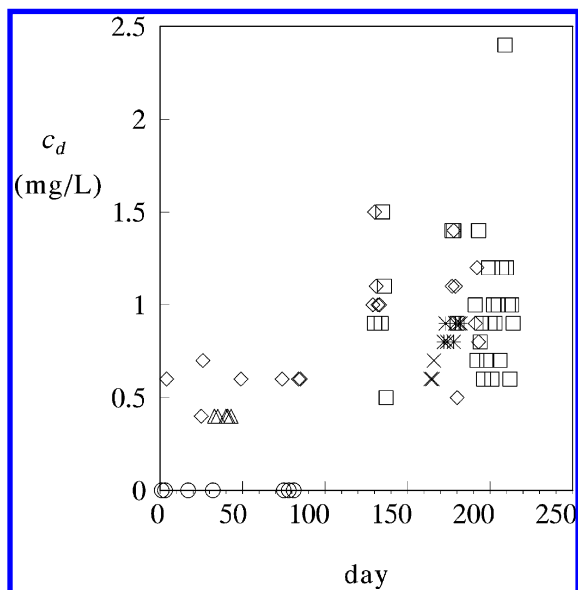

Figure 5. Variation of the concentration of fluoride in the distillate, c_d , with the day of operation: \circ , \triangle , \times , $*$, still 2, October 2006–April 2007; \diamond , still 1, October 2007–April 2008; \square , still 2, February–May 2008; concentration of fluoride in the feed c_f (mg/L) = 5 (\circ), 10 (\triangle), 15 (\times), 20 ($*$), and 10–11.5 (\diamond , \square). The circles indicate that c_d was below the detection limit of 0.3 mg/L. The days are numbered as indicated in the caption to Figure 4. The c_f values reported for the period October 2006–May 2007 are nominal values that do not include the contribution from tap water. The concentration of F^- in tap water was measured subsequently and was found to be in the range 0.1–0.6 mg/L.^{33,46}

The triangles, crosses, and asterisks in Figure 5 show the following: (i) for c_f in the range 10–20 mg/L, c_d was above the detection limit and (ii) c_d appeared to increase as c_f increased.

Sahoo et al.¹⁶ also found that the distillate contained F^- . Their results seem to be consistent with observation (ii), as their c_f (0.2–0.4 mg/L) was lower than ours, and hence their c_d was also lower (<0.05 mg/L). However, further experiments are needed to verify this trend. In field trials of single basin stills at one location, it was found that c_d values were 0.1 mg/L for two stills, 0.6 mg/L for one still, and below the detection limit for another still.¹⁸ In those experiments, c_f was in the range 6.0–7.6 mg/L. The average value of c_d reported by Antwi et al.¹⁷ for $c_f = 20.65$ mg/L was 0.8 mg/L, which is comparable to our data (Figure 5). Similarly, for $c_f = 10$ mg/L, the values of c_d reported by Balakrishnan et al.²⁴ were in the range 0.02–0.54 mg/L.

A redeeming feature of our data is that the 95% upper confidence limit for c_d was below the desirable limit of 1 mg/L for $c_f = 5$ –15 mg/L and was 1.1–1.2 mg/L for $c_f = 20$ mg/L. The latter values are slightly above the desirable limit,¹ but below the permissible limit of 1.5 mg/L.

The pH of the distillate was in the range 7.3–7.8, which is within the desirable range¹ of 6.5–8.5. Its conductivity was 40 $\mu\text{S}/\text{cm}$, which was much lower than that of tap water (250 $\mu\text{S}/\text{cm}$).

Solar Distillation (October 2007–May 2008). The volume of the distillate, V_d , was in the range 0.2–3.0 L/m²·day, as shown by the triangles and crosses in Figure 4. During February 2008, V_d for still 2 was usually higher than that for still 1, suggesting that there were more leaks of vapor and distillate from the latter. On most of the days, V_d was higher during 2006–2007 than during 2007–2008. However, a proper comparison is not possible, as the distillate was collected over a period of about 24 h during 2006–2007, and a period of only about 7 h (from 10 or 11 a.m. until 5 or 6 p.m.) during 2007–2008.

For $c_f = 10$ –11.5 mg/L, c_d was in the range 0.4–1.5 mg/L (except for one data point which had $c_d = 2.4$ mg/L), as shown by the diamonds and squares in Figure 5. The outlier probably resulted from an error in measuring the fluoride concentration. Compared to the previous year, c_d was somewhat higher in 2007–2008. Accumulation of F^- in the sand may be responsible for the observed trend, but more work is needed to verify this conjecture. The 95% upper confidence limit for c_d was <1 mg/L for about 27% of the samples of the distillate and <1.5 mg/L for about 85% of the samples.

Effect of pH and Temperature of the Feed on the Concentration of F^- in the Distillate. In response to comments of the reviewers, some experiments were conducted by varying the pH and the temperature of the feed. Still 3 (area = 0.49 m², mass of sand = 2.75 kg, $\beta = 13^\circ$, $\gamma = 0^\circ$) and still 4 (area = 0.48 m², mass of sand = 2.60 kg, $\beta = 16^\circ$, $\gamma = 0^\circ$), which were similar in design to stills 1 and 2, were used during the period October–November 2011. Here the angles β and γ define the orientation of the still (see Figure 3). For the estimation of the fluoride concentration of the distillate c_d , the SPADNS method of Bellack and Schouboe²³ was used along with the colorimeter developed by Rohit et al.²⁵

The pH of the feed was varied as follows. Either 8 N NaOH solution (0.045–0.210 mL) or 8 N NaHSO₄·H₂O solution (0.22–0.90 mL) was added to 0.7 L of tap water, and 0.5 L of the solution was fed to the still. In all the experiments, the feed was at room temperature ($\approx 24^\circ\text{C}$).

The values of c_d were approximately independent of the pH, and in the range 0.03 ± 0.03 – 0.13 ± 0.03 mg/L, except for pH values near 7.0 and 10.0 (Figure 6). (Here the numbers following the plus-or-minus signs represent the 95% confidence

limits.) In the latter case, the values were slightly higher (0.14 ± 0.02 – 0.20 ± 0.02 mg/L).

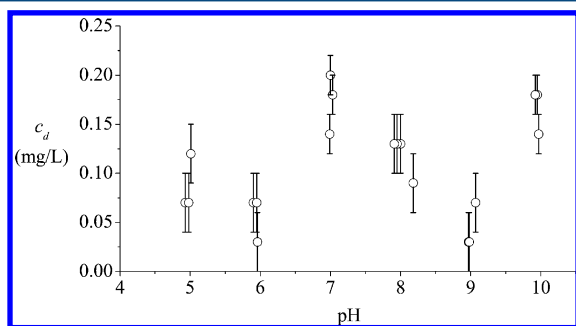

Figure 6. Effect of pH of the feed on the concentration of F^- in the distillate, c_d . The concentration of F^- in the feed, c_f , was in the range 10.0 ± 0.8 – 12.2 ± 0.8 mg/L. Still 3 was used for all the experiments, except for pH ≈ 9.0 , in which case still 4 was used. The error bars and the numbers following the plus-or-minus signs represent the 95% confidence limits. The experiments were conducted during the period Oct 21–Nov 22, 2011.

In another set of experiments, the temperature of the feed was varied by heating it over a gas stove to a desired temperature before pouring it into the still. This procedure permitted only the initial temperature T_{if} of the feed to be varied, as the still was not equipped with a heater. Hence the temperature of the water in the still could not be maintained at a specified value, given the time-dependent flux of the incident solar radiation.

The values of c_d were approximately independent of T_{if} and were in the range 0.03 ± 0.03 – 0.12 ± 0.02 mg/L for T_{if} values in the range 23.5 – 63 °C (Figure 7). For $T_{if} = 81$ – 82 °C, the c_d values were slightly higher (0.11 ± 0.02 – 0.20 ± 0.02 mg/L).

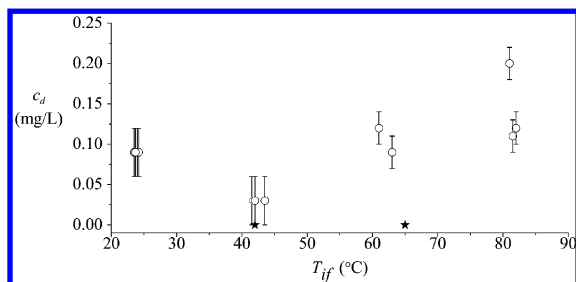

Figure 7. Effect of temperature T_{if} of the feed on the concentration of F^- in the distillate, c_d : ○, solar distillation using still 4, T_{if} = initial temperature, concentration of F^- in the feed $c_f = 10.0 \pm 0.8$ – 12.2 ± 0.8 mg/L; ★, thermal distillation using the setup shown in Figure 8, T_{if} = temperature of the water, maintained constant, $c_f = 11.0 \pm 0.6$ – 12.2 ± 0.6 mg/L. The error bars and the numbers following the plus-or-minus signs represent the 95% confidence limits. The solar distillation experiments were conducted during the period Oct 21–Nov 12, 2011, and the thermal distillation experiments were conducted during the period Nov 20–Dec 11, 2011.

A few thermal distillation experiments were also conducted in the laboratory by using the setup shown in Figure 8, with a stainless steel tray and a glass funnel. Unlike the still, this setup permitted the temperature of the water to be maintained constant during the course of the experiment. The water temperature was maintained at either 65 or 42 °C in two sets of experiments. A duration of 5 h was required to collect a distillate of volume 30 mL in the former case. Over 12 h were

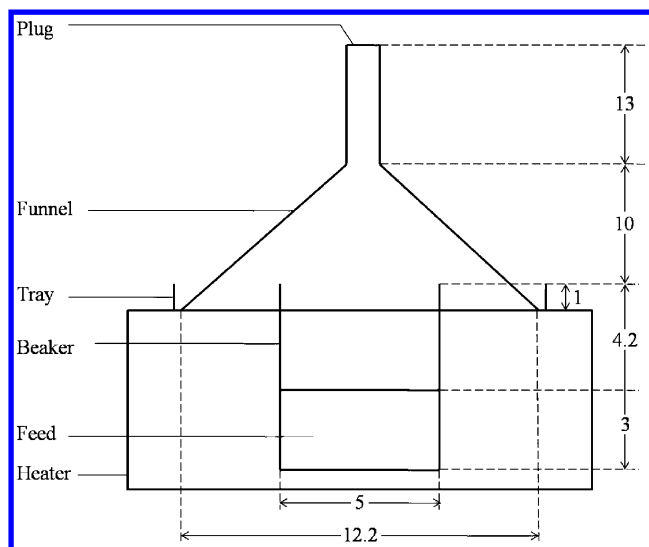

Figure 8. Schematic of a batch distillation setup. All dimensions are in centimeters. Reproduced with permission from Balakrishnan et al.²⁴ Copyright 2011 by the American Chemical Society.

required to collect the same volume of distillate in the latter case, because the rate of evaporation of water decreases when its temperature decreases. The asterisks in Figure 7 show that the values of c_d were less than the detection limit of 0.02 mg/L, and hence less than the values obtained using solar distillation.

Overall, the results suggest that the pH and the initial temperature of the feed do not significantly affect the concentration of F^- in the distillate, at least in the pH range 5.0–10.0 and in the temperature range 24–65 °C.

Possible Reasons for the Occurrence of F^- in the Distillate. The presence of F^- in the distillate is surprising, as NaF is expected to be a nonvolatile electrolyte at the temperature and pressure prevailing in the still. As the distillate channel is open to the atmosphere, the pressure is expected to be close to the atmospheric pressure. During the period from October 2007 to May 2008, the temperature of the vapor in the still T_v was measured by inserting a thermometer through the inlet used for feed water (Figure 2). At a point that was about 10 mm above the air–sand interface, the values of T_v , usually measured at some time between 10 and 11 a.m., were in the range 45–72 °C.

Some possibilities for the occurrence of F^- in the distillate are (i) entrainment of water droplets along with the water vapor, (ii) formation of volatile HF in the liquid phase, (iii) occurrence of a phase equilibrium between NaF in the aqueous and vapor phases, (iv) formation of a cluster of water molecules that are hydrogen bonded to a F^- ion²⁶ and evaporation of this cluster as a single entity, with the Na^+ ion somehow tagging along, and (v) condensation of water vapor on aerosols.²⁴ Possibilities (i) and (ii) were suggested by J. M. Prausnitz.²⁷ However, he noted that (ii) was unlikely unless the pH of the solution was very low. In the present experiments, the pH values of both the feed and the distillate were above 7.0 in most of the cases, and the concentration of F^- in the distillate was approximately independent of the pH (Figure 6). More experiments are required to check whether any of these conjectures are correct, but recent work²⁴ suggests that mechanism (v) may be relevant.

Rainwater Harvesting. During the period Oct 28, 2006–Nov 25, 2006, rainwater falling on the glass plate was collected

using the channel (Figure 2). The volume of water collected, V_v , was 2.1–8.0 L/m²·day, a figure that was comparable to, and often exceeded, the volume of water produced by solar distillation (see Figure 4). Further, the fluoride concentration of the rainwater was close to the detection limit of 0.3 mg/L, which is below the permissible limit. Hence rainwater can be used to supplement other sources of defluoridated water, as suggested by Gupta and Sharma.²⁸

The following experiment attests to the benefits of drinking rainwater. A nongovernmental organization called BAIF had assisted people in some villages of the state of Karnataka, India, to harvest the rainwater falling on the rooftops of their houses and use it for cooking and drinking. A woman whose back had become bent because of skeletal fluorosis said,²⁹ “After BAIF constructed the rooftop rain water harvesting structure in my house, I started drinking water from the same, and within 6–7 months, I could see the difference. Now, even though there has been very slight improvement in my posture, I have been totally cured of my pains.”

Similarly, in Yellampalli village in the state of Karnataka, rainwater is being used by some people for cooking and drinking. Owing to various constraints, the water collected lasts for only a part of the year.³⁰ During the rest of the year, these people are forced to drink groundwater, whose fluoride concentration is above the permissible limit. In such cases, solar distillation can be used to supplement the rainwater.

Cleaning of the Stills and Accumulation of Solids in the Trays. During the period 2006–2008, the stills were operated without cleaning the trays. However, on one occasion, a mercury thermometer that was inserted into the inlet of the still (Figure 2) broke, and the sand was discarded. During the experiments conducted in 2011, the upper surface of the glass plate (Figure 1) was wiped with a wet cloth to remove the dust once a week. The time required for the mass of solids in the bed to increase significantly, say by 30%, may be estimated as follows.

During the experiments conducted in 2011, the concentration of total dissolved solids (TDS) in the tap water used to prepare the feed was 295 ± 21 mg/L, and the maximum volume of feed used was 0.5 L/day. As the output of distillate was very low on some days, water was not fed to the still the next day. However, for the present purpose of estimating the mass of solids added to the tray m_a , we assume that the volume of feed evaporated is 4 L/m²·day, or 2 L/day for a collector area of 0.49 m², which corresponds to the area of still 3. Considering a TDS of 320 mg/L and a mass of sand $m_s = 2.8$ kg, it takes 3.6 years for $m_a = 0.3m_s$.

Cost of the Still and the Area of the Collector Required per Family. Based on the figures for 2006, the cost of a still was about Rs. 850 (US\$16), excluding the cost of sand, minor machining, etc. (Table 1).

Table 1. Cost of the Solar Still^a

item	cost (Rs.)
aluminum tray	450
glass plate	200
C-clamps (six)	100
aluminum frame for the plate	50
miscellaneous	50
total	850

^aUS\$1 ≈ Rs. 52.

The requirement of water for cooking and drinking is estimated to be in the range 10–20 L/day per family. Using the range 0.4–4 L/m²·day for V_d , the collector area required for an output of 10 L/day of distilled water is 2.5–25 m². The capital cost, based on replication of the present design, is about Rs. 4,000–40,000 (US\$77–770).

■ COMPARISON WITH OTHER METHODS

Many other methods such as adsorption, ion exchange, precipitation, coagulation and precipitation, electrocoagulation, electrodialysis, and reverse osmosis have also been used for defluoridation.^{5,31} As each method has its drawbacks, it appears that none of them is distinctly superior.

For example, consider adsorption. If the used adsorbent is discarded, F⁻ may gradually leach into the groundwater. Conversely, if it is regenerated and reused, the regeneration effluent contains a high concentration of F⁻ and hence cannot be disposed of directly into the drain. A satisfactory solution to the problem of effluent disposal is still awaited. Similarly, coagulation and electrocoagulation lead to the generation of fluoride-laden sludge which must be disposed of.

In batch operations, precipitation using lime⁵ cannot reduce the concentration c_F of F⁻ in the treated water to below 7.5 mg/L, owing to the value of the solubility product for CaF₂. However, when the equilibria of Ca(OH)₂ are also considered, Reardon and Wang³² state that the lower limit for c_F is about 2 mg/L. The large dosage of lime causes the pH and the concentration of Ca²⁺ to exceed the permissible limits¹ for drinking water.

Reverse osmosis (RO), electrocoagulation, and electrodialysis require electricity, whose supply is often erratic in the rural areas of India. Reverse osmosis also requires pretreatment of the feed and addition of chemicals to prevent fouling of the membranes. The permeate or treated water contains very few ions and has an unpleasant taste.⁵ Hence, either salts must be added or the water must be blended with a part of the feed that has been suitably disinfected. Further, a significant fraction of the feed water, typically 20–75%, is discarded in the form of a retentate stream that may contain a high concentration of F⁻. When some of us visited two villages, we found that the retentate was let out either into a field adjacent to the RO unit (Gokillapur in the state of Andhra Pradesh, India) or into a pond (Yellampalli in the state of Karnataka, India). This is an unsound practice, as the F⁻ may leach into the groundwater.

As the annual rainy season lasts only for a few months in India, people using rainwater harvesting must be able to afford the cost of a sump of adequate capacity, if the water is to be stored and used throughout the year. Contamination of rainwater owing to dirt, bird droppings, etc. is another problem that must be addressed.

Consider solar distillation. The output of distillate per unit area of the collector (the glass plate) is very low on cloudy days. Hence the still cannot supply the required amount of water throughout the year unless the area of the collector is large. Gomkale⁹ assessed the performance of a collection of 90 stills in the village of Awania in the state of Gujarat, India. He noted that improper sealing of joints and leaks in the distillate channel reduced the yield of distillate, and, “the peacocks manage to remove the plastic tubes from the distillate spout and quench their thirst by inserting their beaks inside it”. Further, in arid areas, dust and sand storms necessitate frequent cleaning of the glass plates. In our experiments, monkeys occasionally disturbed the bottles used to collect the distillate (Figure 2).

The fluoride-laden sand has to be eventually disposed of in a safe manner. This is an unresolved problem.

A comparison of the operating costs of various methods is difficult as the figures have been reported for different scales of operation, locations, and times. In the Indian context, laboratory-scale experiments using pellets of activated alumina for adsorption³³ suggest a cost of 30–40 paise/L (US\$0.006–0.008/L) for an output of 10 L/day and a concentration of F^- in the feed $c_f = 3.0$ mg/L. As suggested by SenGupta,³⁴ the cost can be reduced by blending the treated water with the feed. A cost of 30–50 paise/L (US\$0.006–0.010/L) has been reported by Pemmaraju³⁵ for domestic-scale (15 L/day) treatment of water with $c_f \leq 5$ mg/L, using a mixture of MgO and $Ca(OH)_2$ to precipitate F^- . Treated water from some community-level RO plants is currently sold at 10 paise/L (US\$0.002/L). Precipitation using alum and lime³⁶ produces treated water at a lower cost of range 0.10–0.27 paise/L (US\$1.9 $\times 10^{-5}$ –5.2 $\times 10^{-5}$ /L) for community-level plants with $c_f = 2.5$ –6.2 mg/L and capacities in the range 20–180 m³ of treated water/day. The operating cost of solar distillation is negligible, barring costs associated with the fixing of leaks from the tray and the occasional replacement of the glass plate when it breaks. The figures given above do not include depreciation and the cost associated with the reuse or disposal of sludge, regeneration effluent, or, for RO, the retentate.

To summarize, solar distillation is strongly weather-dependent, but the quality of the distillate is relatively insensitive to the nature and concentration of the contaminants in the feed. However, if volatile compounds such as certain pesticides and HCl are present in the feed, they will be partially transferred to the distillate.^{18,37} In contrast, most of the other methods are weather-independent, but the quality of the treated water is strongly affected by the concentration of contaminants in the feed. A judicious combination of methods, rather than a single method, may be a preferable approach.

■ SIGNIFICANCE OF THE PRESENT WORK

Even after several decades of research work and field studies, there have been very few defluoridation systems that were used continuously for more than a few years in rural areas. A successful example was the use of an adsorption/ion-exchange system based on activated alumina.³⁸ It was attached to a hand pump at Makkur village in the state of Uttar Pradesh, India, and functioned well for 4 years. However, the used adsorbent had to be regenerated by experts from outside the village. The system was abandoned in 1998 as safe water from an alternative source was piped to the village. On the other hand, the Nalgonda technique, which is based on precipitation using alum and lime,³⁹ did not fare well. About 30 years after the first report of this technique, Daw³⁸ noted that, “it did not achieve a great deal of success in field applications..., primarily because of its need for constant attention.” This lack of attention to detail plagues most of the existing methods. The methods used in the present work, namely, solar distillation and rainwater harvesting, are relatively simple. Hence it is likely that they can be used for extended periods of time, without major interventions from the users.

For example, solar stills were set up in a mining town in Chile and used from 1872 for more than 30 years⁴⁰ to provide drinking water. The existence of other types of defluoridation systems of similar longevity does not appear to have been reported in the literature. The stills used in Chile had an area of about 4800 m², which is nearly 10⁴ times larger than that of the

stills used in the present work. Thus the stills have been successfully used over a wide range of scales.

Now consider rainwater harvesting. It has been widely used by people in various countries over extended periods of time. The problem of microbial contamination of the rainwater⁴¹ must be addressed, but overall, rainwater harvesting appears to be an effective method for obtaining drinking water that contains safe levels of F^- . Two of us met a family in Yellampalli village that had been drinking rainwater for several months of the year for over 2 years. The people were very satisfied with the functioning of the rainwater harvesting system, and they said that their joint pains had decreased after they started drinking the rainwater.

■ CONCLUSIONS

Solar distillation is an effective technique for defluoridation, if the feed concentration $c_f \leq 5$ mg/L. For c_f in the range 10–20 mg/L, most of the fluoride is removed, but its concentration in the distillate, c_d , may exceed slightly the desirable limit of 1 mg/L in some cases. The values of c_d were found to be approximately independent of the pH of the feed and the feed temperature, for pH values in the range 5.0–10.0 and feed temperatures in the range 24–65 °C. Further work is needed to examine whether the repeated use of the same bed of sand in the still leads to a gradual increase in the fluoride concentration of the distillate. In many parts of India, where c_f exceeds the permissible limit, it is often < 5 mg/L. Hence solar distillation can be used in such places with a negligible running cost. Based on the data obtained during the periods October 2006–May 2007 and October 2007–May 2008, it appears that a collector area of 2.5–25 m² is required to obtain about 10 L/day of distilled water at Bangalore, and the capital cost is Rs. 4,000–40,000 (US\$77–770). As the concentration of F^- in the rainwater is below the desirable limit, it can also be used for cooking and drinking. Overall, solar distillation and rainwater harvesting provide a ray of hope to the people in remote areas, who have been battling the scourge of fluorosis for many decades.

■ APPENDIX: ESTIMATING THE OPTIMUM ORIENTATION OF AN INCLINED STILL

The material in this appendix has been adapted from Sukhatme and Nayak,²² Klein,⁴² and Anderson.⁴³

Let \bar{H}_T denote the monthly average of the daily solar radiation incident on a unit area of a tilted surface. An approximate expression relating \bar{H}_T to \bar{H} , the monthly average of the daily solar radiation incident on a unit area of a horizontal surface is given by²²

$$\frac{\bar{H}_T}{\bar{H}} = \left(1 - \frac{\bar{H}_d}{\bar{H}}\right)\bar{R}_b + \left(\frac{\bar{H}_d}{\bar{H}}\right)\bar{R}_d + \bar{R}_r \quad (\text{A.1})$$

where \bar{H}_d is the monthly average of the daily diffuse radiation incident on a unit area of a horizontal surface, and \bar{R}_b , \bar{R}_d , and \bar{R}_r are the tilt factors for beam or direct, diffuse, and reflected solar radiation, respectively.

Based on data for India, \bar{H}_d is approximated by²²

$$\frac{\bar{H}_d}{\bar{H}} = 1.411 - 1.696 \left(\frac{\bar{H}}{\bar{H}_0}\right) \quad (\text{A.2})$$

where \bar{H}_0 is the monthly average of the daily extraterrestrial solar radiation incident on a horizontal surface. The ratio \bar{H}/\bar{H}_0 may be approximated by

$$\frac{\bar{H}}{\bar{H}_0} = a + b \left(\frac{\bar{S}}{\bar{S}_{\max}} \right) \tag{A.3}$$

with $a = 0.18$ and $b = 0.64$ for Bangalore.²² In eq A.3, \bar{S} is the monthly average of the sunshine hours per day (see Table 2),

Table 2. Monthly Average of the Sunshine Hours per Day \bar{S} at Bangalore⁴⁵ and Representative Day of the Month \bar{n}_m Used in Calculation of the Radiation Flux

month	\bar{S}	\bar{n}_m
January	10.2	17
February	9.2	16
March	9.9	16
April	9.2	15
May	7.9	15
June	4.8	11
July	3.3	17
August	4.3	16
September	4.4	15
October	7.1	15
November	5.6	14
December	6.3	10

and \bar{S}_{\max} , the monthly average of the maximum sunshine hours per day, is given by²²

$$\bar{S}_{\max} = \frac{2\omega_{ss,d}}{15}; \quad \omega_{ss,d} = \cos^{-1}(-\tan \delta \tan \phi) \tag{A.4}$$

where ω is the hour angle, the subscript "ss" indicates that ω corresponds to sunset on a horizontal surface, and the subscript "d" indicates that the hour angle must be expressed in degrees in eq A.4. Here ϕ is the latitude of the location of the still (Figure 9a), and the declination δ is the angle between $m-e$ or the equatorial plane and the line OS joining the center of the earth to the sun. The hour angle ω is the angle between the projection of OS onto the equatorial plane and the line Om that is drawn due south of the observer (Figure 9b). Following Klein,⁴² the hour angle is assumed to be positive for locations that are west of the observer (for example, at sunset) and negative for locations that are east of the observer (for example, at sunrise).

As both the declination δ and the hour angles corresponding to sunset and sunrise vary with the day of the month, a representative day of the month, \bar{n}_m , is used for each month. Values of \bar{n}_m are listed in Table 2. The declination is given by²²

$$\delta \text{ (deg)} = 23.45 \sin \left(\frac{360(294 + n)}{365} \right) \tag{A.5}$$

Here n is the day of the year, calculated using the value of \bar{n}_m . For example, for February, $\bar{n}_m = 16$ (Table 2) and hence $n = 47$.

The tilt factors \bar{R}_d and \bar{R}_r are given by⁴³

$$\bar{R}_d = \frac{1 + \cos \beta}{2}; \quad \bar{R}_r = \rho \frac{1 - \cos \beta}{2} \tag{A.6}$$

where ρ is the reflectivity of the ground, taken to be 0.2.

Following Klein,⁴² the tilt factor \bar{R}_b is approximated as

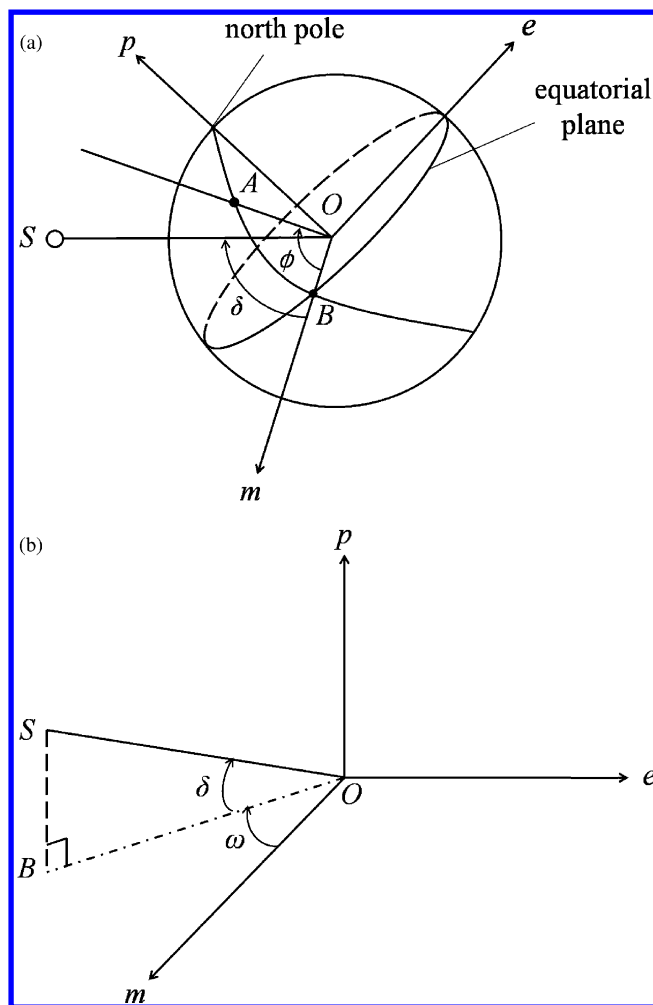

Figure 9. (a) The coordinate system used to define the latitude ϕ and the declination δ . Here A denotes the location of the still and OS represents the line joining the center of the earth to the sun. (b) The hour angle ω and the declination δ . Here OB is the projection of OS onto the $m-e$ or equatorial plane. Adapted from Anderson.⁴³

$$\bar{R}_b \approx \frac{N}{D}$$

$$N = \sin \delta (\sin \phi \cos \beta - \cos \phi \sin \beta \cos \gamma) (\omega'_{ss} - \omega'_{sr}) + \cos \delta (\cos \phi \cos \beta + \sin \phi \sin \beta \cos \gamma) (\sin \omega'_{ss} - \sin \omega'_{sr}) - \cos \delta \sin \beta \sin \gamma (\cos \omega'_{ss} - \cos \omega'_{sr}) \tag{A.7}$$

$$D = 2(\cos \delta \cos \phi \sin \omega_{ss} + \omega_{ss} \sin \delta \sin \phi)$$

where ω'_{ss} and ω'_{sr} are the hour angles corresponding to sunset and sunrise, respectively, on an inclined surface.

The angles ω'_{ss} and ω'_{sr} are obtained by setting $\cos \theta = 0$, where θ is the angle between the outward normal to the glass plate of the still (Figure 3) and the line joining any point on the surface of the plate to the sun. The result is^{42,43}

$$\omega'_{ss} = \min(\omega_{ss}, \arccos[(AB + \sqrt{A^2 - B^2 + 1}) / (A^2 + 1)])$$

$$\omega'_{sr} = -\min(\omega_{ss}, \arccos[(AB - \sqrt{A^2 - B^2 + 1}) / (A^2 + 1)]); \quad \gamma < 0 \tag{A.8}$$

$$\omega'_{ss} = \min(\omega_{ss}, \arccos[(AB - \sqrt{A^2 - B^2 + 1}) / (A^2 + 1)])$$

$$\omega'_{sr} = -\min(\omega_{ss}, \arccos[(AB + \sqrt{A^2 - B^2 + 1}) / (A^2 + 1)]); \quad \gamma > 0$$
(A.9)

where

$$A = \frac{\sin \phi}{\tan \gamma} + \frac{\cos \phi}{\tan \beta \sin \gamma};$$

$$B = \tan \delta \left(\frac{\cos \phi}{\tan \gamma} - \frac{\sin \phi}{\tan \beta \sin \gamma} \right)$$
(A.10)

Equations 12 and 13 in Klein's paper⁴² are identical to eqs A.8 and A.9, respectively, except that the signs in front of the terms involving the square root have been erroneously interchanged in his paper. Klein⁴⁴ concurs with this statement.

By choosing suitable values of the angles β and γ , \bar{R}_b , and hence the incident flux \bar{H}_T on a tilted surface (see eq A.1), can be maximized.

AUTHOR INFORMATION

Corresponding Author

*E-mail: kesava@chemeng.iisc.ernet.in.

Present Addresses

[†]Wipro, Bangalore, India.

[‡]Degremont Ltd., Gurgaon, India.

Notes

The authors declare no competing financial interest.

ACKNOWLEDGMENTS

A part of this work was presented at the "Water for All" conference held at Amrita Vishwa Vidyapeetham, Coimbatore, India, Feb 5–6, 2009. The proceedings were not published. We are grateful to Mr. S. Vishwanath for directing us to the work of Thomas, Profs. S. Balasubramanian, J. M. Prausnitz, and V. Weiss, and Mr. R. Balakrishnan for helpful discussions and Mr. Mahadeva Rao for fabricating the stills. We are grateful to the reviewers for their helpful comments.

REFERENCES

- (1) Bureau of Indian Standards. *Indian Standard Specifications for Drinking Water IS:10500*; Bureau of Indian Standards: New Delhi, 1993.
- (2) World Health Organization. *Guidelines for Drinking-water Quality*, 4th ed.; World Health Organization: Geneva, 2011.
- (3) Shortt, H. E.; Pandit, C. G.; Raghavachari, T. N. S. Endemic fluorosis in Nellore district of South India. *Indian Med. Gaz.* **1937**, *72*, 396–398.
- (4) Shortt, H. E.; McRobert, G. R.; Barnard, T. W.; Nayar, A. S. M. Endemic fluorosis in the Madras Presidency. *Indian J. Med. Res.* **1937**, *25*, 553–568.
- (5) Ayooob, S.; Gupta, A. K.; Bhat, V. T. A conceptual overview on sustainable technologies for the defluoridation of drinking water. *Crit. Rev. Environ. Sci. Technol.* **2008**, *38*, 401–470.
- (6) Jamwal, N.; Manisha, D. B. Wah India. *Down to Earth* **2003**, *11*, 35–41.
- (7) Dunkle, R. V. Solar water distillation: the roof type still and a multiple effect diffusion still. *International Developments in Heat Transfer, Boulder, CO, USA*; University of Colorado: Boulder, Colorado, 1961; Vol. 5, pp 895–902.
- (8) Bloemer, J. W.; Eibling, J. A.; Irwin, J. R.; Lof, G. O. G. A practical basin-type solar still. *Sol. Energy* **1965**, *9*, 197–200.

(9) Gomkale, S. D. Operational experience with solar stills in an Indian village and their contribution to drinking water supply. *Desalination* **1988**, *69*, 177–182.

(10) El-Nashar, A. M. Performance of the solar distillation plant at Abu Dhabi. *Desalination* **1989**, *72*, 406–424.

(11) Le Goff, P.; Le Goff, J.; Jeday, M. R. Development of a rugged design of a high efficiency multi-stage solar still. *Desalination* **1991**, *82*, 153–163.

(12) Tiwari, G. N.; Singh, H. N.; Tripathi, R. Present status of solar distillation. *Sol. Energy* **2003**, *75*, 367–373.

(13) Fukui, K.; Nosoko, T.; Tanaka, H.; Nagata, T. A new maritime lifesaving multiple-effect solar still design. *Desalination* **2004**, *160*, 271–283.

(14) Anjaneyulu, L. *Defluoridation of Drinking Water and Estimation of Fluoride*; M. E. Project Report; Indian Institute of Science: Bangalore, 2007.

(15) Kumar, E. A. *Defluoridation of Drinking Water*; M. E. Project Report; Indian Institute of Science: Bangalore, 2008.

(16) Sahoo, B. B.; Sahoo, N.; Mahanta, P.; Borbora, L.; Kalita, P.; Saha, U. K. Performance assessment of a solar still using blackened surface and thermocol insulation. *Renewable Energy* **2008**, *33*, 1703–1708.

(17) Antwi, E.; Bensah, E. C.; Ahiekpor, J. C. Use of a solar water distiller for treatment of fluoride-contaminated water: The case of Bongo district of Ghana. *Desalination* **2011**, *278*, 333–336.

(18) Hanson, A.; Zachritz, W.; Stevens, K.; Mimbela, L.; Polka, R.; Cisneros, L. Distillate water quality of a single-basin solar still: laboratory and field studies. *Sol. Energy* **2004**, *76*, 635–645.

(19) Thomas. Locally fabricated solar distillation still for drinking water. <http://www.planetkerala.org> (accessed 2006).

(20) Ranjha, A. Y.; Peralta, R. C.; Skergan, T. M.; Marx, D. B. Potential solar earth-water distillate yields in Africa. *Sol. Energy* **1986**, *36*, 451–458.

(21) Kobayashi, M. Method of obtaining water in arid lands. *Sol. Energy* **1963**, *7*, 93–99.

(22) Sukhatme, S. P.; Nayak, J. K. *Solar Energy*, 3rd ed.; Tata McGraw-Hill: New Delhi, 2008.

(23) Bellack, E.; Schouboe, P. J. Rapid photometric determination of fluoride in water. Use of sodium 2-(p-sulfophenylazo)-1,8-dihydroxynaphthalene-3,6-disulfonate-zirconium lake. *Anal. Chem.* **1958**, *30*, 2032–2034.

(24) Balakrishnan, R.; Sankannavar, R.; Rao, K. K. A mechanism for the occurrence of ions in distilled water. *Ind. Eng. Chem. Res.* **2011**, *50*, 13202–13209.

(25) Rohit; Kanwar, L.; Rao, K. K. Development of a low-cost portable colorimeter for the estimation of fluoride in drinking water. *Sens. Actuators, B* **2010**, *149*, 245–251.

(26) Balasubramanian, S. Private communication, 2009.

(27) Prausnitz, J. M. Private communication, 2008.

(28) Gupta, S. K.; Sharma, P. An approach to tackling fluoride problem in drinking water. *Curr. Sci.* **1995**, *68*, 774.

(29) Angadi, M. A *Tale of Nine Villages*; BAIIF Institute for Rural Development—Karnataka: Tiptur, India, 2008.

(30) Rohit, S. Private communication, 2009

(31) Meenakshi; Maheshwari, R. C. Fluoride in drinking water and its removal. *J. Hazard. Mater.* **2006**, *137*, 456–463.

(32) Reardon, E. J.; Wang, Y. A limestone reactor for fluoride removal from wastewaters. *Environ. Sci. Technol.* **2000**, *34*, 3247–3253.

(33) Kanwar, L. *Defluoridation of Drinking Water Using Activated Alumina*. M.Sc. (Eng.) Thesis, Indian Institute of Science, Bangalore, 2010.

(34) SenGupta, A. K. Private communication, 2011.

(35) Pemmaraju, M. A Magnesia Based Sustainable Method for Defluoridation of Contaminated Groundwater. Ph.D Thesis, Indian Institute of Science, Bangalore, 2008.

(36) Nawlakhe, W. G.; Paramasivam, R. Defluoridation of potable water by Nalgonda technique. *Curr. Sci.* **1993**, *65*, 743–748.

(37) Sankannavar, R. *Use of a Solar Still for Treatment of Drinking Water, Rainwater Harvesting, and Disposal of Spent Zirconium-SPADNS*

Solution; M. E. Project Report; Indian Institute of Science: Bangalore, 2011.

(38) Daw, R. K. Experiences with domestic defluoridation in India. *30th WEDC International Conference on People-Centred Approaches to Water and Environmental Sanitation, Vientiane*; WEDC: Loughborough University, 2004; pp 1–7.

(39) Nawlakhe, W. G.; Kulkarni, D. N.; Pathak, B. N.; Bulusu, K. R. Defluoridation of water by Nalgonda technique. *Indian J. Environ. Health* **1975**, *17*, 26–65.

(40) Hirschmann, J. R. Solar distillation in Chile. *Desalination* **1975**, *17*, 17–30.

(41) Dean, J.; Hunter, P. Risk of gastrointestinal illnesses associated with the consumption of rainwater: a systematic review. *Environ. Sci. Technol.* **2012**, *46*, 2501–2507.

(42) Klein, S. A. Calculation of monthly average insolation on tilted surfaces. *Sol. Energy* **1977**, *19*, 325–329.

(43) Anderson, E. E. *Fundamentals of Solar Energy Conversion*; Addison-Wesley: Reading, MA, USA, 1983.

(44) Klein, S. A. Private communication, 2008.

(45) Mani, A. *Handbook of Solar Radiation: Data for India 1980*; Allied Publishers: New Delhi, 1980.

(46) Dajibhai, B. S. *Defluoridation of Drinking Water Using Activated Alumina as an Adsorbent*; M. E. Project Report; Indian Institute of Science: Bangalore, 2011.