

National Rural Employment Guarantee Act
Watershed Works Manual

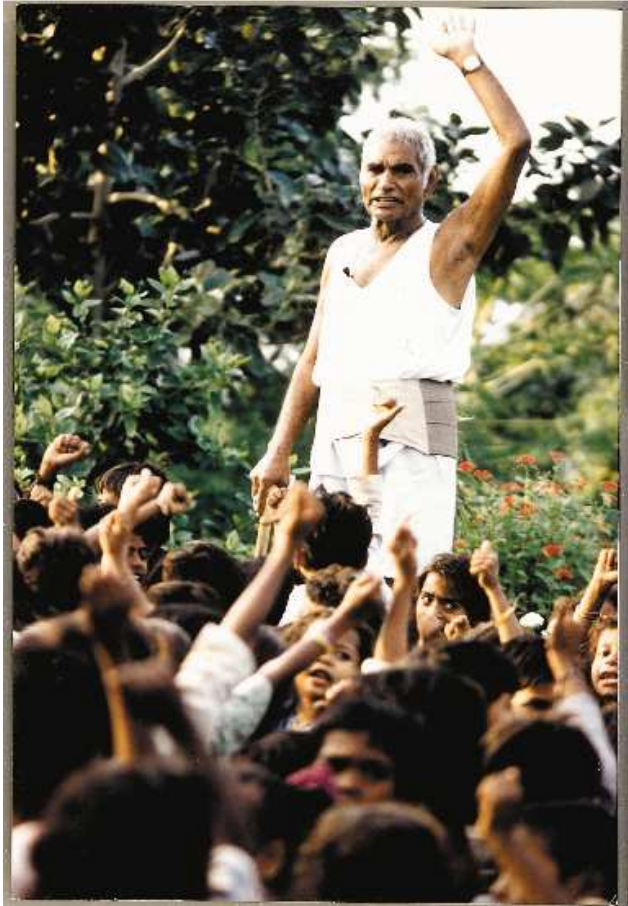

Baba Amte Centre for People's Empowerment
Samaj Pragati Sahayog

July 2006



As a nation today, we face a crisis of faith and credibility. Moving to the remote tribal regions, the bonds grow more tenuous and fragile. Each one of us has to reach out, to intimately experience the sorrows and tribulations of peoples and cultures who feel increasingly marginalised. I look to our young to provide the energy and the healing touch – a touch suffused with creativity and imagination for building anew from the earth.

The Indian village, like a woman, carries the entire nation in her womb. For a healthy nation to develop she needs careful nurturing. Becoming one with our village people, we must give back what we have taken away from them – their self-confidence and control over their own destiny.

When the trainee becomes the trainer, hands become eloquent. Eloquent hands refuse to carry a beggar's bowl. Eloquent hands not only build homes and factories, they also build nation, a culture, a people.

*We haste on heedless, forgetting the flowers on the roadside hedge
Yet they breathe, unaware of our forgetfulness, filling it with music.*

Baba Amte
—————

National Rural Employment Guarantee Act
Watershed Works Manual

Baba Amte Centre for People's Empowerment
Samaj Pragati Sahayog

July 2006

Contents

Foreword	i
1 NREGA: Context and National Significance	1
1.1 The Context	1
1.2 Potential Significance of an Employment Guarantee	2
1.3 NREGA	4
1.4 Water Resource Development in India	5
1.5 Improved Life of Dams and Revival of Fallen Water Tables also Requires Watershed Development	10
1.6 Food Security in 2020	11
1.7 Revitalising Rural Governance	13
2 NREGA Guidelines	15
2.1 Objectives of NREGA	15
2.2 Application of the Act	15
2.3 Entitlements: What the NREGA Provides	15
2.4 Procedures of Application for Work	23
2.5 Record of Employment	27
2.6 Works and their Execution	27
2.7 Roles of Different Agencies at Various Levels	29
2.8 Monitoring and Evaluation of Outcomes	36
2.9 Vigilance and Monitoring Committees	37
2.10 Transparency and Accountability: Public Vigilance and Social Audits	37
2.11 Management of Data and Maintenance of Records	53
2.12 Grievance Redressal	55
2.13 States can also implement their own Acts	55
3 Basic Concepts of Watershed Development and Earthen Engineering	57
3.1 Water	57
3.2 Soil	65
3.3 Earthen Dams	70
3.4 Safety Measures When Building with Earth	78
3.5 Topography: Knowing the Lay of the Land	80
3.6 Watershed Interventions	85
4 An Introduction to Social and Institutional Issues in Watershed Development	92
4.1 Participatory Planning	92
4.2 Focus on Equity	94
4.3 The Question of Gender	95
4.4 Voluntary Contributions	98

4.5	Ensuring Transparency and Accountability	99
4.6	Sustainable End-uses of Harvested Water	99
5	Mapping	104
5.1	What is a Map?	104
5.2	Types of Maps	106
5.3	Classification of Toposheets	110
5.4	Using Toposheets for Watershed Demarcation	111
5.5	Calculation of Area of a Watershed	113
5.6	Calculation of Overall Slope of the Watershed	115
6	Technical Surveys of a Watershed	117
6.1	What is Surveying?	117
6.2	Why is Surveying Required?	117
6.3	What is Required for Surveying?	117
6.4	The A-Frame	118
6.5	The Pipe Level	123
6.6	The Dumpy Level	129
7	Ridge Area Treatment: Contour Trenches	139
7.1	Objectives	139
7.2	Location	140
7.3	Distance between Successive Rows of Trenches	140
7.4	Design of Contour Trenches	141
7.5	Layout of Contour Trenches	142
7.6	Staggered vs. Continuous Trenching	143
7.7	Planning Contour Trenches	143
7.8	Solved Numericals	146
7.9	Contour Trenches: DON'Ts	149
8	Ridge Area Treatment: Earthen Contour Bunds	151
8.1	Objectives	151
8.2	Location	152
8.3	The Distance between Contour Bunds	152
8.4	Contour Bunds vs. Contour Trenches	153
8.5	Design	153
8.6	Contour Bunds: Step by Step	157
8.7	Planning Contour Bunds	157
8.8	How to layout these bunds in the ridge area	160
8.9	Learning by Doing: Planning Contour Bunds	161
8.10	Contour Bunds: DOs and DON'Ts	164
9	Drainage Line Treatment: - Loose Boulder Checks	166
9.1	Objectives	166
9.2	Location	167
9.3	Laying out Boulder Checks on a Stream	167

9.4	Learning by Doing	168
9.5	Design	169
9.6	Determining the Height of Different Points of a Boulder Check	171
9.7	Construction	174
9.8	Material	176
9.9	DOs and DON'Ts	176
10	Drainage Line Treatment: Gabion Structure	178
10.1	Objectives	178
10.2	Location	179
10.3	Design	181
10.4	Different Parts of the Gabion	181
10.5	Material	183
10.6	Construction	185
10.7	DOs and DON'Ts	187
10.8	Gabion Structure Along Embankments	188
11	Drainage Line Treatment: Underground Dykes	189
11.1	Objectives	189
11.2	Location	191
11.3	Construction	192
11.4	Boulder Check on Top of the Dyke	195
11.5	DOs and DON'Ts in Dyke Construction	195
12	Drainage Line Treatment and Water Harvesting: Earthen Dams	196
12.1	Objectives	196
12.2	Location	197
12.3	Design	199
12.4	Construction Step by Step	204
12.5	DOs AND DON'Ts	210
12.6	Looking Ahead: Estimation of Reservoir Capacity	211
13	Farm Bunding	213
13.1	Objectives	213
13.2	Planning	214
13.3	Spacing	214
13.4	Design	215
14	Dugout Farm Ponds	223
14.1	What is a Dugout Farm Pond (DOP)?	223
14.2	Why is a DOP made?	223
14.3	Site Selection	224
14.4	How to make a DOP	224
14.5	Special Precautions	225
14.6	Planning a DOP	225
15	Estimation and Costing of Structures	226

15.1	What is a Schedule of Rates?	226
15.2	How do we use a Schedule of Rates?	227
15.3	What an SoR Contains	228
15.4	Precautions While Using SoRs	230
15.5	Some Useful Formulae in Computing Areas and Volumes	232
15.6	Estimation of Quantity of Work	234
15.7	Some Examples of Quantity Estimation and Costing for Watershed Structures	237
16	Schedule of Rates: A Re-Examination	257
16.1	Objectives of NREGA	257
16.2	What does a Task Rate Signify?	258
16.3	How is the Task Rate arrived at?	259
16.4	Problems of Using Schedule of Rates and Possible Modifications	261
16.5	Transparency in the Process of Preparation of SoRs	269
17	Double Entry Accounting for Watershed Works	274
17.1	Withdrawal of Cash from the Project Account by Cheque for Expenditure on Watershed Development Activities	274
17.2	Cash Payment Made for Watershed Development Activities	275
17.3	Salary Payment to WC Secretary	276
17.4	Grants Received from the Panchayat	277
17.5	Cheque Payment Made for Watershed Development Activities	279
17.6	Interest on Project Account	281
17.7	Calculating Balances in the Cash Book	282
17.8	Calculating Ledger Balances	283
17.9	Accounts Transactions at a Glance	286
18	Annexures	288

| List of Annexures

1. Districts Covered by NREGA (June 30, 2006)	288
A.4. Possible Framework for a Gram Rozgar Sevak	294
B.1. Details Needed for Application Registration	295
B.2. Proforma for Job Card	296
B.3. Proforma for Muster Roll	300
B.7. Proforma for Registration Application Register	301
B.8. Proforma of Job Card Register	301
B.9. Employment Register at Gram Panchayat Level	303
B.10. Proforma for Asset Register	304
B.13. Details of Work to be Displayed at the Work Site	306
B.14. NREGA: Information to be Displayed at Public Places	307

| Foreword

In December 2005, the Union Ministry of Rural Development requested Samaj Pragati Sahayog (SPS) to prepare a training manual for the recently passed National Rural Employment Guarantee Act (NREGA). This followed a meeting held at the United Nations Development Programme (UNDP), New Delhi that was attended by a large number of experts in the field, where SPS made a presentation on the possible outline of such a manual. Later in April 2006, a first draft of the manual was peer-reviewed at a consultation at the Ministry of Rural Development, New Delhi by a panel of eminent national experts in the field. The manual that you are now reading is an outcome of this process.

We wish to thank Amita Sharma, Joint Secretary in the Ministry and Neera Burra of the UNDP, for their constant encouragement and advice in the production of this manual, that is also available in Hindi. We would also like to thank the participants at both the consultations for their comments and suggestions. A major part of the cost of producing these manuals was provided by the UNDP. The rest of the expense was borne through support from the Arghyam Trust, Bangalore, Sir Dorabji Tata Trust, Mumbai and Ford Foundation, New Delhi. Our thanks are due to all of them.

The NREGA gives rise to employment schemes different from any other government scheme in one most significant respect. NREGA-based schemes are not welfare schemes ordinarily understood. They are not dependent on the willful munificence of governments. Their implementation depends on the demand of the people who want work. On the one hand, governments will not provide work unless demanded by those who want it. On the other hand, governments are legally bound to provide work if there is a demand for it. Thus, the people who need work must know every provision of the Act in detail so that they can truly benefit from it.

At the same time, it is also true that even though the Act has been passed by Parliament, there is a tremendous pressure of those who oppose the Act. They believe that it is a waste of precious public money. They point to the rampant corruption that has plagued such programmes in the past. It is, therefore, incumbent upon all those who believe in the right to work, to actively participate in ensuring that the NREGA is implemented in a way, which not only guarantees workers their rights but also ensures that the work under the scheme fulfils its potential contribution to sustained improvements in rural livelihoods.

This is the impulse motivating the writing of this manual. It is meant for

those individuals and organisations who will be involved in planning, implementing and/or monitoring NREGA. These can be PRI representatives, grass-roots NGOs or government officials engaged with this process at different levels. These people need to understand the details of NREGA. They need to be aware of the various entitlements of workers under the Act. They must know the procedures for registering workers, application for work, the roles and responsibilities of Gram Sabhas and Gram Panchayats, how to conduct social audit etc. They also should understand how works under the scheme are to be planned and executed. They must have the capacity to work out how structures built are to be costed. They need to know how to maintain accounts properly. If they want to ensure transparency and a corruption-free scheme they have to know all these details. SPS plans to carry out a series of training programmes in the use of this manual. The hope is that the manual will be used by many of those who attended these programmes, to train other people in their own areas where NREGA is being implemented.

The manual is focused on earthen watershed structures, which are labour-intensive works given priority under NREGA. The manual is organised into 17 chapters. The first two chapters provide an introduction to NREGA. They outline the historic significance of the Act and also provide a brief summary of its official guidelines. The next four chapters introduce you to the concepts required for an understanding of the watershed approach through which the structures are to be built and also the concepts used in building these structures. This includes an introduction to the use of maps and also to basic techniques of surveying that help calculate levels and slopes of the land. A separate chapter is devoted to the social and institutional aspects that must inform our approach. Chapters 7 to 14 introduce the most important watershed structures, one by one. Each chapter tells us about why these structures are built, how we decide where to locate them, how we lay them out over the watershed, how their design is arrived at, how we construct them, as also the precautions we need to observe in doing so. Chapter 15 tells us how to use a book called the Schedule of Rates in order to estimate how much each of these structures will cost. It teaches this through a series of numerical examples. Chapter 16 raises a number of questions about the way the Schedule of Rates has been formulated. We provide reasons for why these rates need to be urgently revised. We also suggest that the entire process of arriving at these rates needs to be much more location-specific, as also transparent and participatory in nature. Finally, Chapter 17 teaches the basics of the double-entry system of accounts, through a series of typical transactions to be handled by the implementing agency. We believe that for too long have social activists merely raised questions about transparency and accountability. The most effective way of doing this is to actually show the way forward to everyone by understanding and

adopting rigorous accounting practices. For this we need to understand the basics of accounting. This is what Chapter 17 attempts to teach.

This manual also has 11 annexures. Annexure 1 provides a state-wise list of the districts where NREGA is being currently implemented. Annexure A4 contains a possible framework for a Gram Rozgar Sevak. The remaining annexures provide formats of various forms and registers to be maintained under the Act, such as job card, muster roll, application for registration, job card register, muster roll, asset register etc.

This manual is a labour of love of the SPS team. It is an expression of our deep commitment to the demystification of all expertise. We cannot forget the immense contribution to an earlier version of the manual made by R. Srinivasan (Founder Member SPS). We wish to place on record the inputs of our team of engineers to various chapters -- Muralidhar Kharadia, MS Tiwari, Rajesh Verma and Milind Pandit. Photographs have all been taken by Debashis Banerji, Director, Baba Amte Centre for People's Empowerment. Pinky Brahma Choudhury, Shalinee Ghosh and DS Rawat helped conceptualise the drawings. This manual was collectively visualised and written by members of the SPS core team, who bear full responsibility for any remaining errors.

If the late 20th century was the age of information technology, then surely the defining moment of this age was the worldwide movement for Free/Libre Open Source Software (FOSS). The FOSS movement, with thousands of volunteers collaborating across the globe, has made possible an articulation of information technology to serve the greater common good. We are happy to say that this manual has been produced with such FOSS tools. It has been typeset on a Linux (Mandriva LE 2005) operating system running L^AT_EX 2_ε (t_EX).

In keeping with this spirit of open access to intellectual work, we would like to encourage good-faith unrestricted use of the contents of the manual, provided only that the original source is cited. We hope this manual will be widely used in this spirit to make NREGA a great success.

Nivedita Banerji
Mihir Shah

P.S. Vijay Shankar
Pramathesh Ambasta

Rangu Rao
Jyotsna Jain

Bagli

July 2006

1 | NREGA: Context and National Significance

1.1 The Context

With impressive macro-economic rates of growth and a booming stock market, India is one of the most exciting economies in the world today. India has reportedly displaced the United States as the second most attractive destination for foreign direct investment in the world after China (Business Standard, 2005, p.1). This spectacular overall performance, however, hides one dark spot that the people of India exposed through Verdict 2004. The benefits of this growth have not been evenly distributed. Large parts of India do not find a place on the development map of the country. In a pioneering study on the Domestic Product of States of India, the EPW Research Foundation found that many "low-income and poorly-performing major states have not only persisted with their low-growth syndrome but have also experienced further deceleration in growth rates in the 1990s" (EPWRF, 2003, p.26). World Bank economists Datt and Ravallion (2002) find that "the geographic and sectoral pattern of India's growth process has greatly attenuated its aggregate impact on poverty" (p.1). A study carried out for the Ministry of Finance, Government of India and the UNDP (Mihir Shah *et al*, 1998) provides massive statistical data to establish that there is a concentration of poverty and distress in the drylands of India as also its hilly and tribal areas. This phenomenon of regional imbalance in India's development finds official recognition in the recent *Report of the Inter-Ministry Task Group on Redressing Growing Regional Imbalances* (Planning Commission, 2005) that has developed a list of "170 most backward districts including 55 extremist affected districts". It is clear that extremist violence is also most frequently encountered in areas where backwardness is concentrated.

With 74% of India's under-three children being officially declared as anaemic and 50% of them suffering from moderate to severe malnourishment, 87% of our pregnant women anaemic and scores of starvation deaths across the country, we could be said to be passing through a "nutritional emergency". More than 25 lakh children die in India every year. One in every five children who die the world over is Indian. Infant mortality rates in India are now even higher than in Bangladesh (UNDP, 2005). It has been claimed on the basis of latest unpublished NSS data that "half our rural population or over 350 million people are below the average food energy intake of sub-Saharan Africa countries" (Patnaik, 2005). Suicides by nearly 10,000 farmers in recent years across the country

(Ghosh, 2005) and deaths of thousands of children in Maharashtra, have only served to highlight the depth of the problem.

The problem of unemployment also appears to be gaining alarming proportions. Results of the 55th Round of the National Sample Survey show that there has been a dramatic decline in the rate of employment generation in the latest period. The rate of growth of employment, in terms of the Current Daily Status (CDS) declined from 2.7 per cent per year in the period 1983-1994 to only 1.07 per cent per year in 1994-2000 for all of India. In both rural and urban areas, the absolute number of unemployed increased substantially, and the rate of unemployment (CDS) in rural India as a whole went up from 5.6 per cent in 1993-94 to 7.2 per cent in 1999-00 (NSSO, 2000). A major reason for the low rate of employment generation was the decline in the employment elasticity of agricultural growth, which declined from 0.70 in 1983-94 to only 0.01 in 1994-2000 (Ghosh, 2005). Thus, providing employment to the growing millions of unemployed has to clearly be national priority number one.

1.2 Potential Significance of an Employment Guarantee

A constitution that feels obliged to protect the right to private property, must surely feel similarly obliged to guarantee the right to work, especially when six decades of planned development has failed to do so. Following the explosive rise in unemployment through the 1920s, many Western capitalist countries introduced different forms of unemployment insurance. By the 1980s, constitutions of thirty countries, including eighteen developing nations, had incorporated the right-to-work. In twenty-five countries this right is specified as a work guarantee. The Indian constitution does include the right to work (via Article 41) but this is not a part of the Fundamental Rights, figuring only in the Directive Principles. Various judgments of the Supreme Court have suggested that the state must place the Directive Principles on par with Fundamental Rights. Whether this constitutional obligation is fortified by making the right-to-work a Fundamental Right or a stronger meaning is attributed to the Directive Principles, either way the state has an obligation to protect its people from unemployment. India being a signatory to the Universal Declaration of Human Rights and the ILO Covenant on Economic, Social and Cultural Rights (both of which incorporate the right-to-work), there is an international imperative as well. Planning in India began with the presumption that the only salvation for millions of unemployed in the countryside was for them to get work in industries set up in urban areas. The national humiliation suffered through the massive droughts of the mid-sixties forced a policy rethink. This

resulted in the Green Revolution of the next two decades. But the revolution proved short-lived. Focused primarily on rice and wheat in the already well-endowed alluvial pockets of India, it led to a monumental neglect of our poorest regions. The result -- intense concentration of poverty and distress in certain pockets. Millions of poor peasants here are forced to look for work outside their own farms to make ends meet. National Sample Survey data show that nearly 80 percent of agricultural labour families in India own land. But the capacity of their farms to provide work has been decimated by years of environmental degradation. So they are compelled to work outside as labourers. Public investment directed at increasing the labour-supporting capacity of these farms through massive rainwater harvesting, soil conservation and treatment of their catchment areas must form the centrepiece of a rural employment guarantee in India. To this should be added investments required in education and health care.

This would ensure five things -- one, that the employment guarantee would not merely provide relief in times of distress, it would also be a move towards long-term drought and flood-proofing of Indian agriculture; two, that the economy moves on to a more sustainable growth path, less vulnerable to the vicissitudes of nature; three, that growth will become more effective as an instrument for reducing poverty. Studies have shown that the impact of growth on poverty is higher in areas where social infrastructure is more developed. Where people are educated and healthy, and have access to safe drinking water, they are better able to seize upon development opportunities. So all investments will begin to yield progressively higher returns in these hitherto neglected regions; four, the number of people who depend on a state-sponsored employment guarantee would steadily decline over time because they could revert back to their own farms as also because of a reduction in poverty; and five, that the expenditure incurred on the employment guarantee would be productive, boosting the growth rate of the economy as a whole. Fuelling successive rounds of private investment, it would also create secondary employment opportunities. The extent to which investment can impact poverty and unemployment depends critically upon the forms in which it is embodied. For an employment guarantee to work, it must be focused on labour-absorbing activities and technologies, which lead to growth that in turn provides more jobs.

This would make the employment guarantee truly sustainable in both environmental and fiscal terms. Economic thinking the world-over has in the last two decades been increasingly dominated by a static fiscal fundamentalism. What this line of thinking fails to recognise are the dynamic growth-enhancing dimensions of national investments, that in a country like India, only the government can make. These investments are in any case the most critical national priorities -- universal access to primary education, healthcare,

water, food and work. It is a crying shame that nearly sixty years after independence we have failed to secure them for our people. An employment guarantee focused on these can fuel growth that would in turn help lower the fiscal deficit. For as incomes rise, so would government revenues. At 2 percent of GDP this would be a small price for a social safety net. It would also be a very sound investment to make. And the way we visualise it, the size of the guarantee to be provided by government should fall over time, as people's need to work outside their farms declines. No Fiscal Responsibility Act should override these national priorities. We do not want a zero fiscal deficit that leaves millions of our people hungry, ill, uneducated and out of work.

But to ensure that the burden of expenditure does indeed reduce over time requires that we pay greatest attention to the area of implementation. For it is true that hundreds of thousands of crores spent on such programmes over the last several decades have largely gone down the drain or lined various pockets. Strong social audit mechanisms and penalties are mandatory. This is not merely a matter of preventing fudging of labour payment muster rolls. The much more creative dimensions of corruption arise from the way the Schedule of Rates is deployed both to embroider estimates and cheat labour. Over the last decade of soiling our hands with implementing these programmes on half a million acres of land in four of the most backward states of the country, we have learnt the people have to be involved in all aspects of the work, including site selection, cost estimation and the way work will be measured and paid. The last is the most crucial if we are to secure statutory minimum wages for labour. This is also the only way to achieve required productivity norms. It involves an intense dialogue through regular public hearings led by those who are to work at the site. Jan sunwayis are also a must for transparent presentation of the details of money sanctioned and payments made.

1.3 NREGA

Many of these concerns are sought to be addressed by the National Rural Employment Guarantee Act, 2005 (NREGA) recently passed by Parliament. The Act is the culmination of a long drawn-out struggle by people's organisations to enshrine the Right to Work in our Constitution as a legally enforceable right. NREGA calls for the formulation of a Rural Employment Guarantee Scheme (REGS) by each State Governments within six months of the date of commencement of the Act. The purpose of the Scheme is to give effect to the legal guarantee of work, by providing at least 100 days of guaranteed employment to every rural household whose adult members volunteer to do unskilled manual work subject to the conditions of this Act. Each Rural Employment Guarantee Scheme is required to have the minimum features specified in Schedule I and Schedule II of the Act. It is also expected to enhance people's livelihoods

on a sustained basis, by developing the economic and social infrastructure in rural areas. The choice of works seeks to address the causes of chronic poverty such as drought, deforestation and soil erosion. Effectively implemented, the employment generated under the Act has the potential of transforming the geography of poverty.

1.4 Water Resource Development in India

The central focus of NREGA is on works related to water conservation and watershed development. It recognises the need to make these the centre-piece of public works programmes in India. 1990-2000 was not a happy decade for Indian agriculture. The overall growth rate of crop production declined from 3.72% per annum in the previous decade to 2.29% in the 1990s and that of crop productivity fell from 2.99% per annum to 1.21% in the same periods (Planning Commission, 2002). Average yield levels of rice and wheat have more than halved between 1986 and 2002, indicating a plateauing of productivity in these two major foodgrains. The output of crops grown and eaten by the poorest of the poor (coarse grains, pulses and oilseeds) and grown largely in the drylands, actually declined during this decade and the rate of growth of their yields decelerated considerably (Table 1.1).

Table 1.1
Rate of Growth (%) of Production and Yield of Foodgrains in India, 1962-2003

Crop	1962/65 to 1970/73	1970/73 to 1980/83	1980/83 to 1990/93	1990/93 to 2000/03
Production				
Rice	1.52	2.23	3.56	1.24
Wheat	10.85	4.51	3.81	2.13
Coarse Cereals	0.61	1.32	0.91	(-)0.60
Pulses	(-)0.33	0.38	1.38	(-) 0.93
All Foodgrains	2.28	2.26	2.92	1.08
Oilseeds	1.17	1.82	5.62	(-) 0.62
Yield				
Rice	1.05	1.60	3.01	1.00
Wheat	6.26	2.66	3.19	1.45
Coarse Cereals	0.89	(-)0.15	1.63	1.18
Pulses	0.69	1.88	2.70	0.14
All Foodgrains	1.82	1.86	3.22	1.55
Oilseeds	0.74	0.93	2.47	0.64

Source: Indian Agricultural Statistics, various issues

The rate of growth of foodgrain production also fell steeply from 2.92% recorded between 1980/83 and 1990/93 to 1.08% during 1990/93 to 2000/03. For the first time since the mid-sixties, the 1990s witnessed a rate of growth in foodgrain production, which was lower than the rate of growth of population. As a result, both per capita

foodgrain production and availability were lower in 2000-03 than their pre-Green Revolution (1960-63) levels. The decline has been the sharpest in the 1990s (Table 1.2). Consumption data based on NSS surveys show that foodgrain consumption and calorie intake has declined substantially during the 1990s in aggregate and for the poorest deciles in terms of expenditure (Ghosh, 2005).

Table 1.2
Production and Per Capita Availability of Foodgrains in India, 1960-2003

Year	Foodgrain Output (MT)	Net per capita output (kg/year)			Net per capita availability (Grams/day)		
		Cereals	Pulses	Total	Cereals	Pulses	Total
1960-63	82.0	158	29	187	400	69	469
1970-73	103.5	144	17	162	418	51	469
1980-83	130.8	149	14	163	417	38	455
1990-93	174.8	163	13	176	468	42	510
2000-03	194.3	152	10	162	391	26	417

Source: Indian Agricultural Statistics, various issues

A major reason for the slowdown in agriculture seems to be the precipitous fall in public investment in agriculture. Two major planks of India's water policy since independence have been construction of large irrigation projects and intensive tapping of groundwater through tubewells. Adoption of the water intensive Green Revolution package was made possible by substantial public investment in irrigation. At present, India has the largest irrigated agriculture in the world. However, a remarkable fact is that since the mid-1970s, the rate of expansion of irrigated area has undergone a global decline.

According to the Food and Agriculture Organization (FAO, 2003), the global rate of expansion of irrigated area, which was 2.17% between 1961-63 and 1971-73, steadily came down in the subsequent periods, reaching 1.23% between 1990-93 and 1997-99. The expansion of irrigated area in India also follows a similar pattern. The rate of growth of irrigated area (1.83%) was the lowest in the period 1990-93 to 1999-2000, compared to earlier decades. The reasons for the decline in the rate of growth of irrigated area can be traced to the number of problems faced by these two major thrust areas of water policy at present

1.4.1 Dam Construction

It is estimated that 4400 (large, medium and small) dams have been constructed in India so far (CWC, 2002). The pace of dam construction reached its peak in the 1970s, subsequent to which it slowed down considerably. We must also note that there is a severe financial constraint that restricts the possibilities of growth in surface irrigation based on big dams. Due to delays in construction and consequent cost

overruns, many of the projects taken up spill over from one plan to the next. At the beginning of the Tenth Plan, there were 410 ongoing major and medium (M&M) irrigation projects in the country, some of them dating back to the Fifth Plan period (Planning Commission, 2002). The Steering Committee on Irrigation for the Tenth Plan estimates that total spill-over costs of previous projects to the Tenth Plan will be Rs.1,77,739 crores. However, the total public sector allocation during the Tenth Plan for all irrigation and flood control was only Rs. 1,03,315 crores. The Steering Committee categorically states that "given the large number of projects taken on hand, the frequent changes in project scope, and the escalation of project costs due to a variety of reasons, there is little likelihood that the outlay in the budgets can ever match the total demand". The Steering Committee, therefore, gives top priority to completion of ongoing projects and says, "new projects may be taken up selectively, keeping in view the necessity for removal of regional imbalances and development of drought prone and tribal areas" (Planning Commission, 2002).

Rapidly escalating cost of creating additional irrigation potential is a serious problem faced by M&M irrigation projects. This has happened because the best sites suitable for dam construction have already been covered and only progressively more expensive and socio-economically and ecologically less favourable sites are left for exploration. The cost of creating additional potential from M&M projects had already reached the fairly mind-boggling figure of Rs. 1,42,662 per hectare by the end of the 9th Plan (Planning Commission, 2002). Evidence is also accumulating regarding the ill-effects of over-irrigation, which has become a feature of many irrigation commands. The Ministry of Water Resources estimated the area affected in irrigation project commands and came up with figures of 1.6 million ha. for waterlogging, 3.1 million ha. for salinity and 1.3 million ha. for alkalinity (Vaidyanathan, 1994). It should also be remembered that the track record of development projects in handling the problems of proper rehabilitation of displaced persons has been extremely poor (ILO-ARTEP, 1993). 75% of the displaced (an estimated 15 to 25 million people) have not been rehabilitated. These include the poorest of the poor in the country, such as the tribals. The proportion of tribals displaced by M&M projects could be as much as 40%. The problem of displacement imposes another serious constraint on the expansion of surface irrigation.¹

¹The current proposal to link Himalayan with the Peninsular rivers for inter-basin transfer of water is estimated to cost around Rs. 5,60,000 crores. It is not clear whether land submergence and R&R packages are included in this cost. There are no firm estimates available for running costs of the scheme, such as the cost of power required to lift water. In a country like India which gets seasonal rainfall from monsoons, the periods when rivers have "surplus" water are generally synchronous across the subcontinent. Another key issue is how the reasonable needs of the basin states, which will grow over time, will be taken into account while planning inter-basin transfers. Further, given the topography of India and the way links are envisaged, it might totally bypass the core dryland areas of Central and Western India, which are located

1.4.2 Groundwater Scenario

Of course, the recent expansion in irrigated area owes much more to groundwater. Nearly 60% of the irrigation in the country is from groundwater. Moreover, of the addition to irrigated area of 25.7 million hectares (mha) between 1970 and 1990, groundwater accounted for over 85%. Table 1.3 shows that the area under canal irrigation has ceased to expand significantly since the mid-seventies while the area irrigated by tanks has actually declined. The annual extraction of groundwater in India is over 150 billion cubic metres, which is by far the highest in the world (Tushaar Shah, *et.al.*,2000).²The most dramatic change in the groundwater scenario in India is that the share of tubewells in irrigated area rose from a mere 1% in 1960-61 to 37% in 1999-2000. By the year 2000, tubewells had become the largest source of irrigation in India.

Table 1.3
Share of Various Sources in Net Irrigated Area in India, 1960-2000 (%)

Year	Tubewells	Wells	Tanks	Canals	Others	NIA (mha)
1960-61	1	29	19	42	10	24.7
1970-71	14	24	13	41	8	31.1
1980-81	25	21	8	40	7	38.7
1990-91	30	21	7	35	7	47.8
1999-2000	37	22	5	31	5	56.8
<i>Area Irrigated (mha)</i>						
	Tubewells	Wells	Tanks	Canals	Others	
1960-61	0.2	7.1	4.5	10.3	2.4	24.7
1970-71	4.4	7.5	4.0	12.8	2.5	31.1
1980-81	9.5	8.2	3.2	15.3	2.6	38.7
1990-91	14.3	10.0	3.3	16.7	3.3	47.8
1999-2000	21.0	12.5	2.8	17.6	2.8	56.8
Increment (1970-2000)	16.6	5.0	-1.2	4.8	0.4	25.7
Share in Increments (%)	65%	20%	-5%	19%	1%	100%

Source: Indian Agricultural Statistics, various issues

on elevations of 300+ metres above MSL. It is also feared that linking rivers could affect the natural supply of nutrients through curtailing flooding of the downstream areas. Along the east coast of India, all major peninsular rivers have extensive deltas. Damming the rivers for linking will cut down the sediment supply and cause coastal and delta erosion, destroying the fragile coastal eco-systems. It is also pointed out that the scheme could affect the monsoon system significantly. The presence of a low salinity layer of water with low density is a reason for maintenance of high sea-surface temperatures (greater than 28 degrees C) in the Bay of Bengal, creating low pressure areas and intensification of monsoon activity. Rainfall over much of the sub-continent is controlled by this layer of low saline water. A disruption in this layer could have serious long-term consequences for climate and rainfall in the subcontinent, endangering the livelihoods of a vast population (Rajamani,2005).

²Studies in India have shown that crop yield per cubic metre on groundwater irrigated farms tends to be 1.2-3 times higher than on surface water irrigated farms (Dhawan 1989,167).

Groundwater availability is dependent on the water storage and transmission characteristics of underlying geological strata. Tubewell technology was initially introduced in the alluvial tracts of Indo-Gangetic Plains, which had a favourable geology for this technology. Indiscriminate extraction of groundwater here has lowered the water table to such an extent that a serious question is being posed about the sustainability of such high levels of extraction in a low rainfall tract (HLC, 2001). Assessments by the Central Groundwater Board of the level of groundwater development (GWD)³ provide a grim picture of an impending crisis in the core Green Revolution areas. They show that the alluvial tracts of Haryana and Punjab have already reached the limit beyond which further extraction of groundwater becomes unsustainable. Rajasthan, Tamil Nadu and Gujarat are fast approaching it. This is also reflected in the numbers of critical blocks ("dark" and "overexploited" blocks with GWD > 90%) in these states. Nearly 60% of the blocks in Punjab and 40% of blocks in Rajasthan and Haryana are experiencing overextraction of groundwater.

While these areas where groundwater is relatively plentiful face the threat of overextraction, about 65% of India (comprising mainly the continental shield) is underlain by formations usually referred to as "hard rocks". 'Hard rock' is a generic term applied to consolidated formations with aquifers of low primary intergranular porosity (e.g., granites and basalts). The specific yield⁴ values of these formations are as low as 1 to 3% compared to that of unconsolidated, alluvial formations which are as high as 12 to 18% (GEC, 1984). Most of their groundwater potential comes from secondary porosity, created by the processes of weathering and fracturing. Groundwater resource in hard rocks is characterised by limited productivity of individual wells, unpredictable variations in productivity of wells over relatively short distances and poor water quality in some areas (Narasimhan, 1990). In contrast to alluvial areas (characterized mainly by relatively more pervious geological strata), the groundwater flow regimes in hard rock areas are extremely complex. Most productive aquifers in hard rock areas are located at shallow depths in the zone of water level fluctuations (the vadose and fractured zones). Deeper seated aquifers often have good initial yields, but a tubewell drilled here may be tapping groundwater accumulated over several hundreds of years. Once groundwater has been extracted from a deeper aquifer, its replenishment depends upon the inflow from the shallow system. The path this water has to traverse is characterized by relatively unfavourable media, which greatly slows down the rate of groundwater recharge. This also means that we must be very modest in the rate and depth of

³Level of Groundwater Development (GWD) = Extraction / Utilisation * 100

⁴Specific yield is an indicator of the extent of void space in a rock stratum. It refers to the volume of water per volume of rock strata that will flow into a well (Fetter, 1986)

extraction of groundwater.

Thus, the crucial fact to be monitored in both areas, but even more so in hard rock regions, is the absolute number and share of tubewells in groundwater irrigation, which provides an indication of the rate and depth of extraction. Since their natural rate of recharge is low, great caution has to be exercised in the development of groundwater in hard rock areas. This poses a severe limit to expansion of tubewell technology to areas underlain by these strata.

1.5 Improved Life of Dams and Revival of Fallen Water Tables also Requires Watershed Development

Our review thus far shows that the limits to further expansion of surface and groundwater irrigation through big dams and tubewells are being reached rapidly. This makes the urgency of a different strategy for India's drylands even greater. Such a strategy needs to recognise the location-specific characteristics of different parts of India and also needs to be sensitive to the limits set by the eco-system. This, we believe, is the broad strategy of watershed development. Of course, our intention here is not to raise any debate about alternative strategies. What we would like to emphasise, however, is that the watershed approach represents a win-win situation. For the life of our irrigation sources themselves, whether they are dams (big, medium or small) or wells/tubewells, depends crucially on the treatment of their catchments to reduce rates of siltation, and on groundwater recharge works, which are both key ingredients of watershed development.

The Ministry of Agriculture estimated in 1985 that over 100 million ha of India's geographical area is affected by soil erosion due to surface water run-off. Annual soil erosion due to water in India is estimated to be 5334 million tonnes (roughly 16.35 tonnes per hectare per year) (Dhruvanarayana, 1993). 10 percent of this is deposited in large dam reservoirs, representing loss of their storage capacity of about 1-2% every year. The Himalayan foothills, Western Ghats and North-Eastern States account for over 60 per cent of the total soil erosion in the country. According to the Report of the Inter-Ministry Task Force on Integrating Ongoing Schemes, larger reservoirs in India have lost over 1/3rd of their storage capacity due to siltation. This has resulted in a reduction in area irrigated as also lower electricity generation, thereby rendering the large investments in these projects unviable (Planning Commission, 2004). The problem of reservoir siltation, far in excess of rates estimated before construction, is threatening to lower the life of many large dams (Table 1.4). The siltation rate in Hirakud dam, for instance, is two and a half times more than the rate assumed and, therefore, the expected

Table 1.4
Siltation Status and Life of Big Dams in India

Name of Dam	Design Life (Years)	Annual Rate of Siltation (HAM/1000 Sq.Km.)		Actual Life (Years)
		Assumed	Observed	
Bhakra Nangal	403	4.29	5.95	291
Tungabhadra	311	4.29	5.98	245
Matatila	357	1.33	4.33	108
Panchet	216	6.67	10.48	138
Maithon	210	9.05	12.39	153
Mayurakshi	872	3.75	16.48	198
Shivaji Sagar	5000	6.67	15.24	2200
Hirakud	386	2.52	6.60	147
Gandhi Sagar	930	3.61	9.64	348

Source: Public Accounts Committee (1982-83)

life of the dam has been reduced by more than half.

By reducing siltation rates through control of the volume and velocity of surface water run-off, watershed programmes can make a big contribution to enhancing storage capacities of big dam reservoirs. They can similarly be also effective in restoring fallen water tables in areas that have seen massive groundwater over-exploitation.

1.6 Food Security in 2020

Table 1.5
Projected Demand and Supply of Foodgrains in India
in the Year 2020 (million tonnes)

Projected Food Demand in 2020	307
Average Food Production in Triennium Ending 2002	205
Gap to be met	102
Maximum Possible Contribution of Irrigated Agriculture	64
of which: - From Irrigated Area Expansion	38
- From Increases in Productivity of Irrigated Agriculture	26
Minimum Balance required from Rainfed Agriculture	38
Share of Rainfed Agriculture	37%

Source: Mihir Shah *et al* (1998)

Raising the productivity of neglected rainfed areas is an imperative even for meeting the goal of national food security in the coming years. This is especially important in view of the recent imports of grain by the government. We have estimated that, *even*

in the most optimistic scenario of further irrigation development in India, nearly 40% of national demand for food in 2020 will have to be met through increasing the productivity of rainfed dryland agriculture (see Table 1.5).

Using the High Level Committee on Long Term Grain Policy's middle projections, we get a total foodgrain demand figure of 307 MT. The foodgrain output during the triennium ending 2000 was 205 MT. To maintain food security even at current nutritional levels, 102 MT of foodgrains have to be produced additionally by 2020. We know that cropped area has plateaued in India since 1970. It has remained static at around the 140 million-hectare mark for the last 3 decades. This is no longer a source of increased output in Indian agriculture. As for irrigated agriculture, its contribution can arise from two sources:

1. expansion in the area under irrigation; and
2. yield improvements in the areas already under irrigation

Even if the share of foodgrains in GIA does not fall (which it well might, with the growing crop diversification in Indian agriculture), only an additional 16 million hectares of foodgrain would thereby come under irrigation by 2020. Now since much of this addition to irrigated area would be in eastern India, and given current low yields under irrigated conditions, even under a most hopeful scenario, irrigated yields here are unlikely to cross 3 tonnes per hectare by 2020. We can, therefore, expect *expansion in irrigated area to contribute an additional 38 MT to the total annual output of foodgrains by the year 2020*. Another part of the additional food output could come from yield improvements in the areas already under irrigation. Yields of irrigated agriculture in India began to plateau in the 1990s and have even declined in some areas. Even if we optimistically assume that yield growth of 30 kg/ha is sustained over the next 20 years, the rise in yield by 2020 will be only 0.6 tonnes per hectare. *Thus, areas already under irrigation could contribute an additional 26 MT of foodgrains to the shortfall in 2020*. The total contribution of irrigated agriculture to foodgrain production from both area expansion and yield improvements put together is, therefore, likely to be around 64 MT, still leaving a shortfall of 38 MT of foodgrains in 2020. In other words, even in the best possible scenario of irrigation development, about 40% of the additional supply of foodgrains needed to match future rise in demand will have to come from the unirrigated segment of Indian agriculture, most of which is located in the dryland areas. And this demands that the productivity of drylands be raised through intensive watershed work in these regions. This is what the funds under NREGA could help us do.

1.7 Revitalising Rural Governance

Finally, we need to recognise the enormous potential inherent in NREGA for transforming the entire architecture of rural governance in India. In this era of “reform”, policy-makers have generally been pre-occupied with how to improve governance for the corporate sector. Hardly any attention has been paid to what the rural poor have to go through at the hands of insensitive and non-transparent bureaucracies. If implemented effectively NREGA could become the harbinger of a completely new era of rural governance in India. Chapter 2 outlines in detail the provisions of NREGA that every concerned citizen must learn and share with the panchayats and the rural masses who are involved in the implementation and monitoring of NREGA or are its ultimate beneficiaries. Once NREGA is effectively implemented, we can hope that transparency and social audit will become the buzz-words of panchayat raj in India.

References

1. Business Standard (2005): "India dwarfs USA as FDI hotspot", December 10-11
2. CWC (2002): *Water and Related Statistics*, Central Water Commission, New Delhi: Government of India
3. Datt, Gaurav and Martin Ravallion (2002): "Is India's Growth Leaving the Poor Behind?", *Journal of Economic Perspectives*, 16(3): 89-108
4. Dhawan, B.D. (1989): *Studies in Irrigation and Water Management*, New Delhi: Commonwealth Publishers.
5. Dhruvanarayana, (1993): *Soil and Water Conservation Research in India*, New Delhi: Indian Council of Agricultural Research.
6. EPWRF (2003): *Domestic Product of States of India, 1960-61 to 2000-01*, Mumbai: Economic and Political Weekly Research Foundation
7. Food and Agriculture Organization (2003): *An International Action Programme on Water and Sustainable Agricultural Development*, Rome: FAO.
8. Gazette of India (2005): *The National Rural Employment Guarantee Act, 2005*, No.42 of 2005, New Delhi
9. GEC (1984): *Groundwater Estimation Methodology: Report of the Groundwater Estimation Committee*, Ministry of Irrigation, Government of India, New Delhi
10. Ghosh, Jayati (2005): "The Political Economy of Farmers' Suicides in India", *Sixth Freedom from Hunger Lecture*, New Delhi: Centre for Environment and Food Security
11. HLC (2001): *Report of the High Level Committee on Long Term Grain Policy*, Ministry of Consumer Affairs, Food and Public Distribution, New Delhi: Government of India
12. ILO-ARTEP (1993): *India: Employment, Poverty and Economic Policies*, New

- Delhi: International Labour Organization, Asian Regional Team for Employment Promotion.
13. MoRD (2006): *From Hariyali to Neeranchal: Report of the Technical Committee on Watershed Programmes in India*, Ministry of Rural Development, New Delhi: Government of India
 14. Narasimhan, T.N. (1990): 'Groundwater in the Indian Peninsular Shield: A Framework for Rational Assessment', *Journal of the Geological Society of India*, 36: 353-63.
 15. NSSO (2000): *Employment and Unemployment in India, Key Results of NSS 55th Round (1999-2000)*, National Sample Survey Organisation, Ministry of Statistics and Programme Implementation, New Delhi: Government of India
 16. Patnaik, Utsa (2005): 'It is time for kumbhakarna to wake up', *The Hindu*, August 5
 17. Planning Commission (2002): *Report of the Steering Committee on Irrigation for the 10th Five Year Plan, 2002-07*, New Delhi: Government of India
 18. Planning Commission (2004): *Report of the Inter-Ministry Task Force on Integrating Ongoing Schemes*, New Delhi: Government of India
 19. Planning Commission (2005): *Report of the Inter-Ministry Task Group on Redressing Growing Regional Imbalances*, New Delhi: Government of India
 20. Public Accounts Committee (1982-83): *Hundred and Forty First Report*, Ministry of Planning, Planning Commission (Lok Sabha Secretariat), New Delhi: Government of India
 21. Shah, Mihir (2004): "A Workable Right to Employment", *The Hindu*, 24th August
 22. Shah, Mihir (2004): "NREGA: A Historic Opportunity", *Economic and Political Weekly*, 11th December
 23. Shah, Mihir, D.Banerji, P.S.Vijayshankar and Pramathesh Ambasta (1998): *India's Drylands: Tribal Societies and Development through Environmental Regeneration*, New Delhi: Oxford University Press
 24. Shah, Tushaar *et al* (2000): *Global Groundwater Situation: Overview of Opportunities and Challenges*, International Water Management Institute, Colombo
 25. UNDP (2005): *Human Development Report 2005*, New Delhi: Oxford University Press
 26. Vaidyanathan, A. (1994): *Food, Agriculture and Water (Second India Series Revisited)*, Madras: Madras Institute of Development Studies.

2 | NREGA Guidelines

This chapter provides a summary of the key provisions of NREGA and the official guidelines drawn up by the Ministry of Rural Development, Government of India, for the implementation of NREGA.

2.1 Objectives of NREGA

The basic objective of the Act is to enhance livelihood security in rural areas by providing at least one hundred days of guaranteed wage employment in every financial year to every household whose adult members volunteer to do unskilled manual work. This work guarantee can also serve other objectives: generating productive assets, protecting the environment, empowering rural women, reducing rural-urban migration, fostering social equity, among others.

2.2 Application of the Act

The employment guarantee scheme was launched on 2nd February 2006 in 200 most backward districts of India (see Annexure A.0 for the list of districts). The government says it will be extended to cover the whole country within five years.

2.3 Entitlements: What the NREGA Provides

2.3.1 Employment

1. At least one hundred days of guaranteed wage employment in every financial year to every household whose adult members volunteer to do unskilled manual work in the rural areas notified by the Central Government
2. "Adult" means a person who has completed eighteen years of age
3. The entitlement of 100 days of guaranteed employment in a financial year is in terms of a household. This entitlement of 100 days per year can be shared within the household; more than one person in a household can be employed (simultaneously or at different times).
4. Every adult member of a registered household whose name appears in the job card shall be entitled to apply for work
5. All registered persons belonging to a household shall be entitled to employment for as many days as each applicant may request, subject to a maximum of one hundred days per household in a given financial year.

6. There shall be no limit on the number of days of employment for which a person may apply, or on the number of days of employment actually provided to him/her subject to the aggregate entitlement of the household
7. If several members of a household who share the same job card are employed simultaneously, they should be allowed to work on the same worksite. If unusual circumstances arise whereby members of the same household have to be allocated work on different worksites, the Gram Panchayat should ensure that the job card is duly processed at both worksites.
8. All adult members of the household who register may apply for work.
9. To register, they have to:
 - a) be local residents: 'Local' implies residing within the Gram Panchayat. This includes migrant families of that area, including those that may have migrated some time ago but may return;
 - b) be willing to do unskilled manual work; and
 - c) apply as a household at the local Gram Panchayat.
10. "Household" means the members of a family related to each other by blood, marriage or adoption and normally residing together and sharing meals or holding a common ration card Household means a nuclear family comprising mother, father, and their children, and may include any person wholly or substantially dependent on the head of the family. Household will also mean a single-member family.
11. "Rural area" means any area in a State except those areas covered by any urban local body or a Cantonment Board
12. Applicants who are provided work shall be intimated by the Gram Panchayat/ Programme Officer by means of a letter sent to them at the address given in the job card, and also by a public notice displayed at the offices of the Gram Panchayat and the Programme Officer.
13. Residents of the Gram Panchayat will be given priority in the allocation of work.
14. If a request for work is made to the Gram Panchayat, it should offer employment on the works to be executed by it. If, under any circumstances, this is not possible, the Gram Panchayat may also allocate employment in a work to be executed by any other Implementing Agency in its jurisdiction that has already been approved of in the Annual Plan. The Gram Panchayat may do this either by requesting the Programme Officer or by directing the Implementing Agency and endorsing a copy of the directive to the Programme Officer, who will ensure that the directive is complied with. The Programme Officer will also ensure that the funds needed

for that work are released. The Implementing Agency will be bound to act upon the directive.

15. If the Gram Panchayat decides that employment cannot be given under its own shelf of works, and that employment needs to be given outside the Gram Panchayat, it will inform the Programme Officer.
16. As far as possible, employment shall be provided within a radius of five kilometers of the village where the applicant resides at the time of applying.
17. In cases the employment is provided outside such radius, it must be provided within the Block, and the labourers shall be paid ten per cent. of the wage rate as extra wages to meet additional transportation and living expenses.
18. If some applicants have to be directed to report for work beyond 5 km. of their residence, women (especially single women) and older persons should be given preference to work on the worksites nearer to their residence.
19. A period of employment shall ordinarily be at least fourteen days continuously with not more than six days in a week.
20. Upon receiving intimation from the Gram Panchayat, the Programme Officer will allot work. The Programme Officer will intimate the Gram Panchayat concerned about the employment allotted (That will include inter Gram Panchayat works) so that the employment data are consolidated in the Employment Register at the Gram Panchayat.
21. If a request for employment is made to the Programme Officer and the Programme Officer allots work, he must inform the Gram Panchayat so that the data on works and employment are coordinated at that level too. The Gram Panchayat will also inform the Programme Officer of the employment allotments made. This information sharing should be done on a prescribed proforma on a weekly basis.

2.3.2 Wages

1. Until such time as a wage rate is fixed by the Central Government, every person working under the Scheme shall be entitled to wages at the minimum wage rate fixed by the State Government for agricultural labourers under the Minimum Wages Act, 1948
2. Provided further that the wage rate specified from time to time under any such notification shall not be at a rate less than sixty rupees per day.
3. Labourers shall not be paid less than the minimum wage under any circumstances.
4. The wages may be paid either wholly in cash or in cash and kind provided that at least one-fourth of the wages shall be paid in cash only.
5. The State Government may prescribe that a portion of the wages in cash may be

- paid to the labourers on a daily basis during the period of employment.
6. There shall be no discrimination on the ground of gender. Equal wages shall be paid to both men and women workers, and the provisions of the Equal Remuneration Act, 1976 (25 of 1976) shall be complied with.
 7. It is recommended that wages should be paid on a weekly basis on a pre-specified day of the week in each Gram Panchayat.
 8. It is essential to ensure that wages are paid on time. Workers are entitled to being paid on a weekly basis, and in any case within a fortnight of the date on which work was done. In the event of any delay in wage payments, workers are entitled to compensation as per the provisions of the Payment of Wages Act, 1936
 9. In any case, wages should be paid in a public place, with muster rolls being read out aloud and displayed at the time of payment.
 10. In case, wages are paid through the Bank/Post network, the details of wages paid should be made public.
 11. If workers are willing, then a State Government may consider dovetailing wage payments under REGS with social security arrangements. With the consent of the worker, a proportion of the wages may be earmarked and contributed to welfare schemes organized for the benefit of REGS workers such as health insurance, accident insurance, survivor benefits, maternity benefits and other social security arrangements. Such a social security cover will be purely volitional. No such contributions from the wages received by the worker will be made without the consent of the worker concerned.

2.3.3 Time-rates and Piece-rates

1. Wages may be paid either on a time-rate basis *or* on a piece-rate basis.
 - a) Where wages are paid on a time-rate basis:
 - i. the supervisory authorities will be responsible for ensuring that productivity norms are met;
 - ii. the Implementing Agencies may provide a description of the daily work requirements to facilitate the fulfilment of productivity norms;
 - iii. no worker can be paid less than the daily minimum wage.
 - b) Where wages are paid on a piece-rate basis:
 - i. the work must be of such a nature that each labourer's work can be individually measured;
 - ii. the work norms must be such that any person working at a normal pace for seven hours earns no less than the minimum wage, as per the District

Schedule of Rates.

- iii. measurements must be recorded in a transparent manner whereby individuals may verify their measurements on a daily basis;
 - iv. daily attendance should not be a condition for payment of wages;
2. In building/housing construction works, only skilled labour can be paid on a piece-rate basis.
 3. The State Governments and the programme authorities shall make all efforts to publicize the minimum wage and the task-based rates in simple language and by means easily accessible to the local community. Wage rates shall also be displayed prominently at every worksite.
 4. The Programme Officer, the District Programme Coordinator and the State Government shall keep a watch on the average wages earned under a task-based system. If necessary, the schedule of rates may be revised to ensure that the earnings are near the wage rate. The district-wise average wage earned on a task basis and paid to men and women shall also be brought to the notice of the State Council every year.

2.3.4 Measurement of Work and Schedule of Rates

1. Norms for measurement of work have to be evolved by the States, and the wage norms for piece-rate work listed in the 'Schedule of Rates' should be updated in advance of the implementation of the Employment Guarantee Scheme. The factors underlying this should include:
 - a) ensure that all tasks/works are identified clearly and that nothing remains invisible and underpaid in piece-rate work.
 - b) delineate tasks properly and carefully and to fix rates separately to the extent possible. Each such task should be specified and defined properly, and the clubbing/bundling of separable tasks (e.g. digging and lifting) should be avoided.
 - c) devise productivity norms for all the tasks listed under piece-rate works for the different local conditions of soil, slope and geology types in such a way that normal work for seven hours results in earnings at least equal to the minimum wage.
 - d) devise measurement norms (individual versus collective), reduce time lag between execution and measurement, etc. in order to reduce corruption and underpayment.

2. The State Governments should undertake comprehensive work, time and motion studies. These studies will observe outturn and fix rates after detailed location-specific observations. This implies that productivity norms must follow possible outturn under different geo-morphological and climatic conditions, across and within Districts. This is of particular significance in areas with a high degree of location specificity and variability in the soil, slope and geological conditions and seasonal variation. Therefore, a matrix of rates for the same task needs to be drawn up that follows ecological rather than administrative boundaries.
3. Based on these studies, separate Schedules of Rates should be prepared for each District, to be called 'District Schedule of Rates' (DSR). The DSR may also have further disaggregation within the District, e.g. separate Schedules of Rates for different geographical areas. These rates with standard designs should be proactively disclosed and widely publicized. In particular, the District Schedule of Rates should be posted at worksites in the vernacular, in a manner that is legible and comprehensible to labourers using the simple terminology of 'people's estimates'. The communication exercise in NREGA should include wide publicity of such estimates.
4. The District Schedule of Rates should also be posted on the Internet (on the 'REGS website') and made available for sale on a cost-price basis as a book and on CDs.

2.3.5 Special Provisions for Women and Disabled

1. At least one-third of the beneficiaries shall be women who have registered and requested for work under this Act.
2. If a rural disabled person applies for work, work suitable to his/her ability and qualifications will have to be given. This may also be in the form of services that are identified as integral to the programme. Provisions of the Persons with Disabilities (Equal Opportunities, Protection of Rights and Full Participation) Act, 1995 will be kept in view and implemented.

2.3.6 Worksite Facilities

1. The facilities of safe drinking water, shade for children and periods of rest, first-aid box with adequate material for emergency treatment for minor injuries and other health hazards connected with the work being performed shall be provided at the work site.

2. If there are more than five children below the age of six years crèche facilities will have to be provided. A person (preferably a woman) should be engaged under REGS to look after them. She will be paid minimum wages. Suitable provisions should be made for this in the cost estimates
3. If any personal injury is caused to persons employed by accident arising out of and in the course of their employment, they shall be entitled to, free of charge, such medical treatment as is admissible under the Scheme
4. Where hospitalisation of the injured worker is necessary, the State Government shall arrange for such hospitalisation including accommodation, treatment, medicines and payment of daily allowance not less than half of the wage rate required to be paid had the injured been engaged in the work.
5. If persons employed under a Scheme die or become permanently disabled by accident arising out of and in the course of employment, they shall be paid by the implementing agency an ex gratia payment at the rate of twenty-five thousand rupees or such amount as may be notified by the Central Government, and the amount shall be paid to the legal heirs of the deceased or the disabled, as the case may be.
6. If any personal injury is caused by accident to a child accompanying any person who is employed, such person shall be entitled, free of charge, to such medical treatment for the child as may be specified in the Scheme and in case of death or disablement, through an ex gratia payment as may be determined by the State Government.

2.3.7 Labour-intensive work sans contractors

1. The cost of material component of projects including the wages of the skilled and semi-skilled workers shall not exceed forty per cent of the total project costs. Wages of skilled labourers and mates should be included in the 'material costs'.
2. As far as practicable, tasks shall be performed by using manual labour and not machines.
3. At least 50 percent of the works in terms of cost in a Gram Panchayat will be allotted to the Gram Panchayat for execution. This is the statutory minimum, and the Programme Officer or the District Programme Coordinator may allot more if deemed feasible.
4. The other Implementing Agencies can be Intermediate and District Panchayats, line departments of the Government, Public Sector Undertakings of the Central and State Governments, Cooperative Societies with a majority shareholding by the Central and State Governments, and reputed NGOs having a proven track

record of performance. Self-Help Groups may also be considered as possible Implementing Agencies.

5. Contractors cannot be engaged in any manner in the execution of works.
6. All works on both lists (Panchayat works and general works) will be required to obtain Administrative Sanction and Technical Sanction in advance, by December of the year preceding the proposed implementation.

2.3.8 Unemployment Allowance

1. The Gram Panchayat/Programme Officer shall be responsible for providing wage employment to the applicant within 15 days of the date of receipt of the application.
2. In the case of advance applications, employment will be provided from the date that employment has been sought
3. If a Gram Panchayat is unable to provide employment within 15 days, it will be the responsibility of the Programme Officer to do so. The employment allotted by the Programme Officer will be intimated to the Gram Panchayat and vice versa.
4. If an applicant is not provided employment within fifteen days of receipt of his/her application seeking employment, s/he shall be entitled to a daily unemployment allowance. This entitlement comes into effect as soon as the Act is notified in a particular District or area.
5. The unemployment allowance will not be less than one-fourth of the wage rate for the first thirty days and not less than one-half of the wage rate for the remaining period of the financial year.
6. The unemployment allowance payable to the household shall be sanctioned and disbursed by the Programme Officer or by the Gram, Block or District Panchayats as the State Government may authorise
7. Ideally, unemployment allowances should be paid on a weekly basis at the Gram Panchayat level, on 'employment guarantee day'.
8. Every payment of unemployment allowance shall be made or offered within 15 days from when it becomes due
9. In the event of any delay, the recipients shall be entitled to compensation based on the same principles as wage compensation under the Payment of Wages Act, 1936.
10. The liability of the State Government to pay unemployment allowance to a household during any financial year shall cease as soon as:
 - a) the applicant is directed by the Gram Panchayat or the Programme Officer to report for work or depute at least one adult member of their household; or

- b) the period for which employment is sought comes to an end and no member of the household of the applicant had turned up for employment; or
- c) the adult members of the household of the applicant have received in total at least one hundred days of work within the financial year; or
- d) the household of the applicant has earned as much from the wages and unemployment allowance taken together which is equal to the wages for one hundred days of work during the financial year.

11. An applicant who

- a) does not accept the employment provided to his/her household; or
- b) does not report for work within fifteen days of being notified by the Programme Officer or the implementing agency to report for the work; or
- c) continuously remains absent from work, without obtaining a permission from the concerned implementing agency for a period of more than one week or remains absent for a total period of more than one week in any month,

shall not be eligible to claim the unemployment allowance payable under this Act for a period of three months but shall be eligible to seek employment under the Scheme at any time.

2.4 Procedures of Application for Work

2.4.1 Prior Preparation

1. A Gram Sabha shall be convened when the Act commences. The purpose of the Gram Sabha will be to explain the provisions of the Act, mobilize applications for registration and conduct verifications.
2. A door-to-door survey may also be undertaken to identify persons willing to register under the Act. The survey may be conducted by a team headed by the President of the Gram Panchayat and involving ward members, SC/ST and women residents, a village-level Government functionary and the Panchayat secretary. The team members may be given orientation at the Block/District level.
3. To allow maximum opportunities to families that may migrate, registration will be open throughout the year at the Gram Panchayat office during working hours.

2.4.2 Application for Registration

1. The application for registration may be given on plain paper to the local Gram Panchayat.

2. It should contain the names of those adult members of the household who are willing to do unskilled manual work, and particulars such as age, sex and SC/ST status.
3. The details that must be included in an application for registration are indicated in Annexure B.1.
4. The State Government may make a printed form available, but a printed form will not be insisted upon.
5. An individual may appear personally and make an oral request for registration.

2.4.3 Verification

1. The GP will verify
 - a) local residence in the Gram Panchayat concerned
 - b) whether the household is really an entity as stated in the application
 - c) whether applicants are adult members of the household.
2. The process of verification shall be completed as early as possible, and in any case not later than a fortnight after the receipt of the application in the Gram Panchayat.

2.4.4 Registration

1. After verification, the Gram Panchayat will enter all particulars in the Registration Register in the Gram Panchayat.
2. Every registered household will be assigned a unique registration number. The registration number shall be assigned in accordance with a coding system similar to that prescribed by the Central and State Governments for the BPL Census 2002.
3. The registration shall be for a period not less than five years, and may be renewed from time to time.
4. Copies of the registration will be sent to the Programme Officer for the purpose of reporting to the Intermediate Panchayat and District Panchayat for further planning, tracking and recording. This must be done immediately, so that the Programme Officer has a consolidated record of likely demand to enable him to organize resources accordingly.
5. A Gram Sabha of registered workers must be held.
6. If a person who applies for registration turns out to have submitted incorrect information regarding his/her name, residence or adult status, he/she will become ineligible. In such cases, the Gram Panchayat will refer the matter to the Programme Officer. The Programme Officer, after independent verification of

facts and giving the concerned person an opportunity to be heard, may direct the Gram Panchayat to cancel such registration and job card. Such cancellation lists will have to be made public and should be presented to the Gram Sabha.

2.4.5 Job Cards

1. The Gram Panchayat will issue job cards to every registered household.
2. The job card should be issued immediately after verification, i.e. within a fortnight of the application for registration.
3. Job cards should be issued in the presence of the local community.
4. Photographs of applicants have to be attached to the job cards.
5. The identity portion of the job card may be laminated.
6. The cost of the job cards, including that of the photographs, will be borne as part of the programme cost. It will in no event be charged to the applicants.
7. The State Government in a particular area may order the photograph to be affixed later (within three months) if the immediate provision of a photograph is not practicable.
8. A copy of the job card will be maintained at the Gram Panchayat.
9. The job card shall be valid for a period of five years and will have provision for the addition/deletion of members eligible to work. Deletions in any household on account of demise, or permanent change of residence of a member, are to be reported immediately by the household concerned. Additions desired may be applied for by the household.
10. The Gram Panchayat will also undertake an annual updating exercise in the same manner as registration, the time for which should be fixed keeping in mind the work and migration season of the local workforce.
11. All additions and deletions made in the Registration Register will be read out in the Gram Sabha. The Gram Panchayat will send a list of additions/deletions to the Programme Officer.
12. The essential features of the job card proforma are suggested in Annexure B.2.
13. The proforma of the job card should be such that it contains permanent information regarding the household as well as the employment details for five years. Permanent information will include the household registration number and particulars (such as age and sex) of all adult members of the family who are willing to work.
14. The entitlements of REGS workers and the other basic features of NREGA may be printed on the reverse of the job cards to promote wider awareness of the Act.
15. Individual identity slips may be given to each registered applicant of the family The

identity slip should contain the information given in page 2 (identity portion) of the job card, including the registration number of the household.

16. A cardholder may apply for a duplicate job card if the original card is lost or damaged. The application will be given to the Gram Panchayat and shall be processed in the manner of a new application, with the difference being that the particulars may also be verified using the duplicate copy of the job card maintained by the Panchayat.
17. If a person has a grievance against the non-issuance of a job card, he/she may bring the matter to the notice of the Programme Officer. If the grievance is against the Programme Officer, he/she may bring it to the notice of the District Programme Coordinator or the designated grievance-redressal authority at the Block or District level. All such complaints shall be disposed off within 15 days.

2.4.6 Application for Work

1. Applications for work should generally be submitted to the Gram Panchayat. But they may also be submitted to the Programme Officer
2. Applications should be given in writing on plain paper, stating:
 - a) the registration number of the job card;
 - b) the date from which employment is required; and
 - c) the number of days of employment required.
3. Applications for work must be for at least fourteen days of continuous work.
4. Every adult member of a registered household whose name appears in the job card shall be entitled to apply for unskilled manual work.
5. There shall be no limit on the number of days of employment for which a registered person may apply, or on the number of days of employment actually provided to him/her subject to a maximum of one hundred days per household in a given financial year.
6. Provision shall be made in the Scheme for advance applications, that is, applications which may be submitted in advance of the date from which employment is sought.
7. Provision shall also be made for submission of multiple applications by the same person provided that the corresponding periods for which employment is sought do not overlap.
8. A single application may be given for a number of days in different periods during the year for which employment is required.
9. Joint applications may also be submitted by several applicants.

10. The Gram Panchayat and Programme Officer, as the case may be, shall be bound to accept valid applications and to issue a dated receipt to the applicant.
11. Applicants who are provided with work shall be so intimated in writing, by means of a letter sent at the address given in the job card and by a public notice displayed at the office of the Panchayats at the district, intermediate or village level.
12. Information on new applications for work shall be conveyed at least once a week by the Gram Panchayat to the Programme Officer. At the same time, the Gram Panchayat shall specify how many of the new applicants are being employed on 'Panchayat works' (and for how long), and how many are to be provided employment by the Programme Officer on works other than by the GP

2.4.7 Employment Guarantee Day

1. It is recommended that in each Gram Panchayat, a particular day of the week ('employment guarantee day') should be earmarked for processing work applications and related activities such as disclosure of information, allocation of work, payment of wages and payment of unemployment allowances.
2. However, these activities should not be restricted to 'employment guarantee day'. In particular, applications for work should be accepted at any time.
3. The President of the Gram Panchayat and any staff appointed with the Gram Panchayat (Gram Rozgar Sevak) to assist with REGS should be present on 'employment guarantee day'.

2.5 Record of Employment

1. Every agency making payment of wages must record on the job card the amount paid and the number of days for which payment has been made.
2. A copy of the muster roll of every work will be sent by the Programme Officer to those Gram Panchayats from which workers are employed and in whose jurisdiction the work is executed. The Gram Panchayat will consolidate household-wise employment data in the Employment Register. The format of the Employment Register is given in Annexure B.9.

2.6 Works and their Execution

1. The intention of the National Rural Employment Guarantee Act (NREGA) is to provide a basic employment guarantee in rural areas. The Act indicates the kinds of works that may be taken up for this purpose. As per Schedule I of the Act,

the focus of the Rural Employment Guarantee Scheme (REGS) shall be on the following works:

- a) water conservation and water harvesting;
- b) drought proofing, including afforestation and tree plantation;
- c) irrigation canals, including micro and minor irrigation works;
- d) provision of irrigation facility to land owned by households belonging to the Scheduled Castes and Scheduled Tribes, or to land of the beneficiaries of land reforms, or to land of the beneficiaries under the Indira Awas Yojana;
- e) renovation of traditional water bodies, including de-silting of tanks;
- f) land development;
- g) flood-control and protection works, including drainage in waterlogged areas;
- h) rural connectivity to provide all-weather access. The construction of roads may include culverts where necessary, and within the village area may be taken up along with drains.
- i) any other work that may be notified by the Central Government in consultation with the State Government.

2. The above list of permissible works represents the initial thrust areas. In some circumstances, locations or seasons, it may be difficult to guarantee employment within this initial list of permissible works. In such circumstances new categories of work may be added to the list on the basis of consultations between the State Governments and the Central Government. Proposals for new categories of work should be framed by the State Employment Guarantee Council and referred to the Ministry of Rural Development.
3. The maintenance of assets created under the Scheme (including protection of afforested land) will be considered as permissible work under NREGA. The same applies to the maintenance of assets created under other programmes but belonging to the sector of works approved in Schedule I of the Act (see above).
4. Creation of durable assets and strengthening the livelihood resource base of the rural poor shall be an important objective of the Scheme.
5. Care must be taken to ensure that the improvements envisaged under REGS work to benefit the weaker sections in the area. In particular, land development works should begin with the land of small and marginal farmers.
6. NREGA resources should not be used for land acquisition. Land belonging to small and marginal farmers or SC/ST landowners cannot be acquired or donated for works under the programme.
7. To avoid duplication a unique number should be given to each work

8. To ensure sustainable assets and a holistic approach to planning, a Project approach should be adopted towards defining a Work. This will enable subsuming a number of works as activities under an umbrella Work or Project. The Project may be formulated with the Block as a unit so that the Programme Officer may coordinate the activities under it at sub Block levels. Inter Block Projects may also be formulated at the District level.
9. A new work under the Scheme shall be commenced only if-
 - a) at least fifty labourers become available for such work; and
 - b) the labourers cannot be absorbed in the ongoing works.

Provided that this condition shall not be applicable for new works in hilly areas and in respect of afforestation

10. A period of employment shall ordinarily be at least fourteen days continuously with not more than six days in a week.
11. Projects in low-wage areas, where the demand for work at minimum wages is likely to be large, must be formulated on a priority basis.
12. A list of persons who are provided with the work shall be displayed on the notice board of the Gram Panchayat and at the office of the Programme Officer and at such other places as the Programme Officer may deem necessary and the list shall be open for inspection by the State Government and any person interested.

2.7 Roles of Different Agencies at Various Levels

2.7.1 Village Level

2.7.1.1 Gram Sabha

The Act authorizes the Gram Sabha:

1. to recommend works to be taken up under REGS,
2. to monitor and supervise these works, and
3. to conduct social audits of the implementation of the Scheme.
4. In addition, it is suggested that the Gram Sabha be used extensively for facilitating the implementation of the Scheme.
5. The Gram Sabha should be used as a forum for sharing information about the Scheme, for instance, to help people to apply for registration.
6. The Gram Sabha has a crucial role to play in ensuring transparency and accountability. This involves, for instance, verifying applications for registration

and conducting social audits.

The Gram Panchayat shall make available all relevant documents including the muster rolls, bills, vouchers, measurement books, copies of sanction orders and other connected books of account and papers to the Gram Sabha for the purpose of conducting the social audit.

2.7.1.2 Gram Panchayat

The Gram Panchayat has a pivotal role in the implementation of REGS. It is responsible for:

1. identification and planning of works as per the recommendations of the Gram Sabha and the Ward Sabhas,
2. preparing a development plan and maintaining a shelf of possible works to be taken up as and when demand for work arises.
3. registering households,
4. issuing job cards,
5. receiving applications for work,
6. allocating employment,
7. executing 50 percent of the works,
8. maintaining records, and
9. monitoring the implementation of the Scheme at the village level.

It will be very difficult for these tasks to be effectively discharged by the ordinary staff of the Gram Panchayat. Therefore, it may be advisable to appoint an “employment guarantee assistant” in each Gram Panchayat for this purpose. The employment guarantee assistant could be called “Gram Rozgar Sevak”, or an equivalent term in the local language

Every year the Gram Panchayat shall convene a meeting of the Gram Sabha to estimate the demand for labour, and to propose the number and priority of works to be taken up in the next financial year. The timing of the meeting will take into consideration the work season and the migration time, in case the workforce in that area tends to migrate for work. Participation of likely beneficiaries should be ensured in the Gram Sabha so that their priorities and needs shape the Annual Plan. The time and date of the Gram Sabha meeting should be fixed well in advance and should be widely publicized so that people can participate in large numbers.

The recommendations formulated in the Gram Sabha (and the Ward Sabhas, if applicable) will be forwarded to the Gram Panchayat. Based on these recommendations, the Gram Panchayat will prepare an Annual Plan and forward it to the Programme

Officer. The Annual Plan should indicate clearly the existing demand for work, the demand in the previous year, the works taken up in the previous year, ongoing works and works proposed for the next year, likely costs and the proposed Implementing Agencies. The Gram Panchayat will also identify the 50 percent of the works in its area that it may wish to take up.

Each Gram Panchayat will have a single bank account for the purpose of implementing REGS works. This REGS account will be operated jointly by the President of the Gram Panchayat and the Secretary of the Gram Panchayat. Each Gram Panchayat will have a single bank account for the purpose of implementing REGS works. This REGS account will be operated jointly by the President of the Gram Panchayat and the Secretary of the Gram Panchayat. All payments made from the REGS account will be reported to the Gram Panchayat at its next meeting and approval will be obtained. Any objection will be recorded and a copy of the minutes will be sent immediately to the Programme Officer for necessary action.

Funds from the REGS account may be spent on REGS works only in cases where these works have received the required Administrative Sanction and Technical Sanction from the competent authorities. The President of the Gram Panchayat will be personally liable for any expenditure made without such sanctions.

The REGS-related accounts of the Gram Panchayat shall be presented for scrutiny at the biannual social audits of the Gram Sabha, in pre-specified formats.

REGS funds at the Gram Panchayat level cannot be used for other purposes under any circumstances. The Gram Panchayat President and the Gram Panchayat Secretary shall be responsible for ensuring that disbursements from the REGS account are made for legitimate purposes. Any diversion of REGS funds will be treated as a defalcation and recovery proceedings will be immediately initiated using the strongest possible legal instruments.

After 60 percent of the allocation given to any Gram Panchayat has been spent, the Gram Panchayat may apply to the Programme Officer for release of additional funds. The proposal of the Gram Panchayat shall be accompanied by a statement of work-wise expenditure together with the report of the vigilance and monitoring committee duly approved by the Gram Sabha.

The Programme Officer, after satisfying himself about the proper utilization of the earlier allocations, will ensure the release within 15 days of the next instalment, equal to the amount utilized by the Gram Panchayat.

To reduce the risk of financial 'leakages', and to promote transparency and accuracy in fund management, the practice of 'monthly squaring of accounts' should be introduced. This consists of verifying that *all* the money released under NREGA is

accounted for under the following three heads:

1. Money held in bank accounts at various levels;
2. Advances to implementing or payment agencies;
3. Vouchers of actual expenses.

Details of the monthly squaring of accounts should be made publicly available on the Internet at all levels of aggregation.

2.7.2 Block Level: Intermediate Panchayat and Programme Officer

The functions of the Panchayat at intermediate level shall be:

1. to approve the Block level Plan for forwarding it to the district Panchayat at the district level for final approval;
2. to supervise and monitor the projects taken up at the Gram Panchayat

A Programme Officer will be appointed at the Block level with necessary support staff for facilitating implementation at the Block level. The Programme Officer will not be below the rank of the Block Development Officer. The Programme Officer essentially acts as a 'coordinator' for REGS at the Block level. Among his important functions are: scrutinizing village plans; matching employment opportunities with the demand for work at the Block level; supervising the implementing agencies; safeguarding the entitlements of REGS workers; ensuring that regular social audits of all works within the jurisdiction of the Gram Panchayat are carried out by the Gram Sabha and that prompt action is taken on the objections raised in the social audit; sanctioning and ensuring payment of unemployment allowance to the eligible households; ensuring prompt and fair payment of wages to all labourers and responding to complaints. Ultimately, the chief responsibility of the Programme Officer as coordinator of REGS at the Block level is to ensure that anyone who applies for work gets employment within 15 days. The Programme Officer will assist the Intermediate Panchayat in its functions. He will be answerable to the District Programme Coordinator.

The Programme Officer will scrutinize the Annual Plan sent by Gram Panchayats for technical feasibility. He will satisfy himself that it meets the likely demand for employment based on the registrations and previous experience. He will ascertain that the employment opportunities arising from the projects in the area under his jurisdiction match the demand for employment. If the Programme Officer feels that the list is insufficient to meet the likely demand, he should ask for a supplementary list.

The Programme Officer is expected to prepare a plan for the Block by consolidating the proposals of the Gram Panchayats and Intermediate Panchayats. The Intermediate Panchayat has to approve and forward the Block plan to the District Panchayat.

The Programme Officer shall supply each Gram Panchayat with

1. the muster rolls for the works sanctioned to be executed by it; and
2. a list of employment opportunities available elsewhere to the residents of the Gram Panchayat.

The Programme Officer will not reject a proposal received from the Gram Panchayat. If the proposal is not within the parameters of the Act, or appears technically infeasible, the Programme Officer will record his observations on the proposal and then submit a consolidated statement of proposals to the Intermediate Panchayat. The Intermediate Panchayat will not reject a work proposed by the Gram Panchayat if it is within the parameters of the Act. If it is outside the parameters of the Act, then it will be returned to the Gram Panchayat for this body to replace it with a valid proposal.

The Intermediate Panchayat will maintain the priority indicated by the Gram Panchayat. It is possible that there may be a need for works that involve more than one Gram Panchayat. Such works may be included by the Intermediate Panchayat. It is, however, reiterated that the priority of works in a Gram Panchayat will be as determined by the Gram Panchayat. On the basis of these discussions, the plan for the area of the Intermediate Panchayat will be approved by the Intermediate Panchayat and forwarded to the District Programme Coordinator.

2.7.3 District Panchayats and District Programme Coordinator

District Panchayats will be responsible for

1. finalizing the District Plans by approving the block-wise plans and
2. for monitoring and supervising the Employment Guarantee Scheme in the District.

The State Government will designate a District Programme Coordinator (DPC), who can be either the Chief Executive Officer of the District Panchayat, or the District Collector, or any other District-level officer of appropriate rank. The DPC shall be responsible for the overall coordination and implementation of the Scheme in the District.

The District Programme Coordinator will scrutinize the plan proposals of all the Intermediate Panchayats, examining the appropriateness and adequacy of works in terms

of likely demand as well as their technical and financial feasibility. He will also invite and examine work proposals from other Implementing Agencies, but in doing so, the priorities of the Gram Panchayat and the priorities of inter Gram Panchayat works as indicated in the Block Plan by the Intermediate Panchayat will be retained. He will consolidate all these proposals into a District Plan proposal to be discussed and approved by the District Panchayat. The time frame for each project must be specified in the Annual Plan. The District Plan will comprise a Block-wise shelf of projects. The Block-wise shelf of projects will be arranged Gram Panchayat-wise. The Implementation Agency for each work has to be identified keeping in view the mandatory minimum 50 percent of the works to be executed by the Gram Panchayat. The District Panchayat will examine and approve the District Plan.

The District Programme Coordinator will coordinate the preparation of detailed technical estimates and sanctions. The project report of each approved work shall contain all details as may be specified in the technical/works manual of the State Government. It will also clarify the expected outcomes such as person days of employment, specifications of the physical assets (e.g. length of road, size of a tank) and enduring outcomes (e.g. area irrigated, villages connected).

The District Programme Coordinator will communicate the sanctioned Plan to the Programme Officer. The Programme Officer will forward a copy of the Block Plan with the shelf of projects to be executed in each Gram Panchayat as well as projects that may be inter Gram Panchayat along with cost, time frame, person days to be generated and the Implementing Agency to every Gram Panchayat. Planning for projects must give priority to low-wage areas, where the demand of work at minimum wages is likely to be large. This process must be completed by December of the preceding year.

Approved works should be widely publicized.

The District Programme Coordinator is required to prepare a 'labour budget' by the end of December for the next financial year. This labour budget should contain the details of the anticipated demand for unskilled manual work in the District, and the plan for engagement of labourers in REGS works. It should be submitted to the District Panchayat.

The Annual Plan will be like a rolling plan, since the approved shelf of projects will carry over from one financial year to the next. Thus, the Annual Plan should be seen as part of a longer-term strategy for sustainable employment generation in the District. The Act states that 'creation of durable assets and strengthening the livelihood resource base of the rural poor shall be an important objective of the Scheme'. It is suggested, therefore, that Districts develop Perspective Plans to enable them to assess the causal factors of poverty and possible interventions.

The District Perspective Plan (DPP) is intended to facilitate advance planning and to provide a development perspective for the District. The aim is to identify the types of REGS works that should be encouraged in the District, and the potential linkages between these works and long-term employment generation and sustained development.

A District Perspective Plan of five years will have the advantage of facilitating annual working plans on the basis of which annual budgets can be estimated and drawn up, and also give a continuum to plan works beyond the restriction of a financial year. The District Perspective Plan will serve as a framework of long-term planning, but it will be flexible enough to respond to the new emerging needs of the area, the experience of implementation, and the new works approved by the Central Government.

Generally, a District Perspective Plan will have the following features:

1. Village-based: with the village as the unit for planning
2. Holistic: cover socio-economic aspects of development
3. Diagnostic: include a causal analysis of poverty. This will help identify gaps and needs, and indicate the nature of inputs required.
4. Delineate baselines
5. Indicate outcome-based strategies
6. Indicate methods for measurement of outcomes
7. Map resources

The District Perspective Plan will enable the adoption of a project approach to works rather than just an activity approach. It will also facilitate an inter-sectoral approach, so that Districts can address certain fundamental causes of poverty in the area.

If the Perspective Plan has been made under the National Food for Work Programme (NFFWP), it should be revisited in order to serve the purposes of NREGA. For this purpose the draft Plan should be discussed, and approved with modifications if need be, by the Gram Sabha, Gram Panchayat, Intermediate Panchayat and District Panchayat.

At the village level, efforts should be made to ensure the participation of those who are likely to seek work under the Act. Their demand for work as well as their preference for the nature and time of work should be elicited, so that the Plan becomes an instrument to give them employment according to their need. Each village should develop its Perspective Plan, so that it can benchmark the incremental improvements associated with REGS.

2.7.4 State Employment Guarantee Council (SEGC)

A State Employment Guarantee Council is to be set up by every State Government. The SEGC shall advise the State Government on the implementation of the Scheme,

and evaluate and monitor it. Other roles of the State Council include deciding on the 'preferred works' to be implemented under REGS, and recommending the proposals of works to be submitted to the Central Government by the State Government. The State Council will prepare an Annual Report on the REGS, to be presented to the State Legislature

2.7.5 Employment Guarantee Commissioner

The State Government will designate an officer, not below the rank of a Commissioner, as the State Rural Employment Guarantee Commissioner responsible for ensuring that all activities required to fulfil the objectives of the Act are carried out. The Commissioner may also function as the Member Secretary of the SEGC, and be authorized to hear appeals that may lie against decisions or actions of the DPC. He may also be directed to ensure that the system of grievance redressal, social audit, application of the right to information, and other measures of public accountability and transparency are effective as well as responsive to the demands of REGS workers and the community.

2.7.6 Central Employment Guarantee Council (CEGC)

A Central Employment Guarantee Council will be set up by the Central Government. The Central Council shall be responsible for advising the Central Government on NREGA-related matters, and for monitoring and evaluating the implementation of the Act. It will prepare annual reports on the implementation of the NREGA and submit these to Parliament. The Ministry of Rural Development will be the nodal Ministry for the implementation of the NREGA. It will set up the Central Council.

2.8 Monitoring and Evaluation of Outcomes

NREGA states that an important objective of the Rural Employment Guarantee Scheme is the 'creation of durable assets and strengthening the livelihood resource base of the rural poor' (Schedule I, Section 2). Investments made under NREGA are expected to generate employment and purchasing power, raise economic productivity, promote women's participation in the workforce, strengthen the rural infrastructure through the creation of durable assets, reduce distress migration, and contribute to the regeneration of natural resources. Thus, outlays for REGS have to be transformed into outcomes. The REGS formulated by the State Governments must indicate the expected outcomes as well as the methods through which the outcomes are to be assessed.

2.9 Vigilance and Monitoring Committees

1. For every work sanctioned under the Scheme, there should be a local vigilance and monitoring committee, composed of members of the locality or village where the work is undertaken, to monitor the progress and quality of work while it is in progress. The Gram Sabha will elect the members of this committee and ensure that SC/STs and women are represented on it.
2. The Implementing Agency should apprise this committee of estimates regarding the work, time frame and quality parameters. The final report of the committee should be attached along with the Completion Certificate of the work, and should also be placed at the next meeting of the Gram Sabha in the Panchayat where work has been executed. A copy of the report will also be sent to the Programme Officer and the District Programme Coordinator.
3. Local beneficiary committees may also be constituted for effective articulation of their entitlements and their access to them. The Programme Officer will be responsible for ensuring that local monitoring committees/beneficiary committees are constituted.

2.10 Transparency and Accountability: Public Vigilance and Social Audits

An innovative feature of the National Rural Employment Guarantee Act is that it gives a central role to 'social audits' as a means of continuous public vigilance. A social audit is an ongoing process through which the potential beneficiaries and other stakeholders are involved at every stage: from the planning to the implementation, monitoring and evaluation. This process helps in ensuring that the activity or project is designed and implemented in a manner that is most suited to the prevailing (local) conditions, appropriately reflects the priorities and preferences of those affected by it, and most effectively serves public interest. Thus, social audits can be seen as a means of promoting some basic norms in public matters:

- **Transparency:** Complete transparency in the process of administration and decision making, with an obligation on the government to *suo moto* give people full access to all relevant information.
- **Participation:** An entitlement for all the affected persons (and not just their representatives) to participate in the process of decision making and validation.
- **Consultation and Consent:** In those rare cases where options are predetermined out of necessity, the right of the affected persons to give informed consent, as a

group or as individuals, as appropriate.

- **Accountability:** The responsibility of elected representatives and government functionaries to answer questions and provide explanations about relevant action and inaction to concerned and affected people.
- **Redressal:** A set of norms through which the findings of social audits and other public investigations receive official sanction, have necessary outcomes, and are reported back to the people, along with information on action taken in response to complaints.

In the context of NREGA, the process of social audit should include modes of public verification of the following 11 stages of implementation:

- Registration of families
- Distribution of job cards
- Receipt of work applications
- Preparation of shelf of projects; selection of sites
- Development and approval of technical estimates; issuance of work order
- Allotment of work to individuals
- Implementation and supervision of works
- Payment of unemployment allowance
- Payment of wages
- Evaluation of work
- Mandatory social audit in the Gram Sabha (Social Audit Forum)

At each of these stages, there are various ways in which the implementation process may fail to meet the norms spelled out earlier. An indicative list of these ‘vulnerabilities’ is given in Table 2.1, along with the possible means of preventing or addressing them.

2.10.1 The Social Audit Forum

Apart from the ongoing process of social audit, there will be a mandatory review of all aspects of the social audit at the Gram Sabha meetings to be held at least once every six months for this purpose. At these ‘Social Audit Fora’ information will be read out publicly, and people will be given an opportunity to question officials, seek and obtain information, verify financial expenditure, examine the provision of entitlements, discuss the priorities reflected in choices made, and critically evaluate the quality of work as well as the services of the programme staff.

Thus, Social Audit Gram Sabhas will not only give people an opportunity to review compliance with the ongoing requirements of transparency and accountability, but will

also serve as an institutional forum where people can conduct a detailed public audit of all NREGA works that have been carried out in their area in the preceding six months.

Table 2.1
Social Audit

No	Stage	Vulnerabilities	Steps to Ensure Transparency and Social Audit
1.	Registration of families whose members are potential REGS workers [Responsibility: Sarpanch /Gram Panchayat Secretary]	<ol style="list-style-type: none"> 1. Absence of the concerned functionary 2. Denial of registration to eligible applicants 3. Incomplete list of adults in each household 4. Registration of bogus families/individuals 5. Rejection of 'incomplete' registration forms 6. Asking for money for registering names/families 	<ol style="list-style-type: none"> 1. The process of registration shall be transparent. It should be carried out publicly, with facilities for people to verify their own details, or those of others. 2. Initial registration shall be carried out at a special Gram Sabha convened for the purpose. 3. A prior survey shall be conducted by the Gram Panchayat to enumerate all the families and their adult members who are eligible to register. This should become a basis for ensuring that all persons who are eligible and wish to be included in the scheme are accounted for. 4. This enumeration will also help in preventing the registration of fictitious/ineligible names, but should not be used to exclude eligible persons who might not have been listed. 5. Subsequent to the initial registration, there shall be a public reading at the Gram Sabha of: <ul style="list-style-type: none"> - list of all registered households - list of registered adults in each registered household. 6. A form, with a tear-away receipt at the bottom, will be used for registration, and the receipt will be given to the registered person/ family. 7. If a form is incomplete in any way, it will be the responsibility of the concerned functionary to have it completed there and then. 8. The final list of registered families/adults will be verified, and complaints of exclusion settled.

No	Stage	Vulnerabilities	Steps to Ensure Transparency and Social Audit
			<p>9. No case of denial of registration can take place without giving the concerned household members an opportunity to be heard. All cases of refusal to register will be brought before the Gram Sabha.</p> <p>10. The final list will be put up for public display at the Gram Panchayat office and updated every three months.</p> <p>11. Subsequent to the initial registration, the process of registration will remain perpetually open at the Gram Panchayat.</p>
2.	Distribution of job cards [Responsibility: Sarpanch]	<ol style="list-style-type: none"> 1. Delay in receiving job cards 2. Issuance of false job cards 3. Issuance of job cards to ineligible persons: <ol style="list-style-type: none"> a. To non-residents; b. To minors; c. To those not members of the listed family. 4. Non-issuance of job cards 5. Asking for money for issuing job cards 	<ol style="list-style-type: none"> 1. There shall be an (enforceable) one-month time limit for the supply of job cards, from the date of registration. 2. The list of job card holders must be updated every month, and be available for inspection at the Gram Panchayat office. 3. A file containing photocopies of all job cards issued shall be open for inspection at the Gram Panchayat office. 4. The job card should state the fact that there is no charge for it. The job card should also list the basic entitlements (including the minimum wage rate) under NREGA on one of its sides
3.	Receipt of work application [Responsibility: Sarpanch/PO]	<ol style="list-style-type: none"> 1. Non-acceptance of work application by the relevant authorities 2. Wrong date or no date recorded on the work application 3. Rejection of 'incomplete' forms. Oral application or request for work being made an excuse for denial of work on time 	<ol style="list-style-type: none"> 1. Individuals may send their applications for work by post or deliver it by hand. 2. They will have the right to an immediate, written, signed and dated receipt. 3. A date-wise list that is updated weekly shall be displayed at the Gram Panchayat office, along with a register detailing the applications received. 4. If an application is incomplete in any way, it will be the responsibility of the concerned functionary to have

No	Stage	Vulnerabilities	Steps to Ensure Transparency and Social Audit
			<p>it completed. An application should not be rejected just because it is incomplete.</p> <p>5. There should be simple pre-formatted forms available, so that anyone who wants to make an oral application can have the form immediately filled for him/ her by the Gram Panchayat officials and get a receipt.</p>
4.	<p>Selection of the public work to be taken up in a particular Gram Panchayat [Responsibility: Sarpanch]</p>	<ol style="list-style-type: none"> 1. Selection of a low priority or inappropriate work 2. Selection of work that serves a vested interest 3. Lack of public support/ cooperation for that work 4. Poor selection of a worksite 	<ol style="list-style-type: none"> 1. The shelf of projects/works to be taken up should be determined by the Gram Sabha. 2. The shelf of projects/works should also be assessed for relevance and priority by the Gram Sabha. 3. A list of the finally selected projects and works, in their order of priority, should be publicly displayed at the Gram Panchayat office.
5.	<p>Development and approval of technical estimates and issuance of work order [Responsibility: Junior Engineer/ Sarpanch]</p>	<ol style="list-style-type: none"> 1. Exaggerated or inaccurate technical estimate 2. Inclusion in estimate of unnecessary expenditure 3. Excessive rates and material 4. Unclear work order that does not make the details of the work clear, or leaves scope for misinterpretation 	<ol style="list-style-type: none"> 1. A technical estimate must be carried out with the involvement of the local people. 2. The technical estimate must be put to the Gram Sabha for approval. 3. The format for the technical estimate must be simple and easily understood by the people. 4. Similarly, a people-friendly format must be used for the sanction and work order. 5. This format must be put on public display, so that people can access this information and understand the details of the work.
6.	<p>Allotment of work [Responsibility: Sarpanch/PO]</p>	<ol style="list-style-type: none"> 1. Giving out-of-turn allotments 2. Favouring or discriminating against people in allotting type/location of work 3. Not respecting the gender quota 	<ol style="list-style-type: none"> 1. Maintain a work allocation register for public scrutiny at the Gram Panchayat office. 2. Ensure that the public is informed through notice boards and through other measures (like drum beating) every time a new batch of work is allotted.

No	Stage	Vulnerabilities	Steps to Ensure Transparency and Social Audit
		<p>4. Not informing the applicant and then marking him/her as absent</p> <p>5. Demanding money for allotting work</p>	<p>The date up to which work has been allocated should also be made public every time work is allocated. 3. Fix a specific day (typically Sunday or the weekly haat day) and a specific time and place (typically at the Gram Panchayat office) to provide information about REGS.</p> <p>4. On that day, ensure that the public is informed of the work allotted or ready to be allotted, along with the names of allottees, their date of application, location and type of work, and other relevant information.</p>
7.	<p>Implementation and Supervision of work [Responsibility: Sarpanch/ PO/ Designated agency]</p>	<p>1. Recording of non-existent (ghost) workers</p> <p>2. Recording of fictitious (ghost) works</p> <p>3. Work not conforming to work specifications or prescribed standards</p> <p>4. Supply of less than sanctioned/poor quality materials and tools</p>	<p>1. An open 'project meeting' with all potential workers and open to people from the Gram Panchayat should be held to explain the work plans, and their details and work requirements before the work commences. The Vigilance and Monitoring committee members should be selected or announced at this meeting.</p> <p>2. At these meetings, for each of the types of work allotted, the wage norms must be explained to the people and put up on the notice board. The questions that must be answered include:</p> <ol style="list-style-type: none"> What is the wage? What is the wage norm (what constitutes a full day's work)? The public must also be told that there will be individual measurements of each person's work, unless a group collectively decides to have joint measurements. <p>3. A board with details of work— estimates and running costs, material, labour and funds—must be put up at every site, and updated regularly. The format must be user friendly.</p> <p>4. The public must be able to access muster rolls on demand.</p> <p>5. Every week, five workers must</p>

No	Stage	Vulnerabilities	Steps to Ensure Transparency and Social Audit
			<p>verify and certify all the bills/vouchers of their worksite.</p> <p>6. A copy of the sanction/work order must be available for public inspection at the worksite.</p> <p>7. There should also be provisions for access to samples of works, to be taken as per the procedure developed for the Right to Information Act, 2005.</p> <p>8. A daily materials register must be kept, and verified by five workers every day.</p> <p>9. The daily/individual measurement records for each work and worker must be available for public inspection.</p> <p>10. The vigilance committee should check the work as per a checklist prepared for them, and their evaluation report should be prepared before every biannual Social Audit Forum as described in the text.</p>
8.	Payment of wages [Responsibility: Implementing/ Designated Agency]	<ol style="list-style-type: none"> 1. Non-payment of wages 2. Late payment of wages 3. Underpayment of wages 4. Payment of wages to the wrong person 5. Payment of wages in the name of non-existent (ghost) workers 6. Payment of wages for non-existent projects 7. Failure to pay minimum wages 	<ol style="list-style-type: none"> 1. Payments should be made in a public place on fixed days to ensure that there is no ambiguity regarding payments. 2. All recipients and amounts of payment must be read aloud to ensure that the illiterate are not cheated, and also to check ghost payments. 3. A list detailing all payments to be made must be put up in a public and easily accessible place prior to the reading aloud of the list. 4. Provisions may be made to facilitate payments through the post office and other financial institutions. 5. Disclosure of piece-rate measurement should be made individually, and not en masse, so as to provide each worker with his/her exact due. This will prevent division of the wage earned by ghost workers, etc.

No	Stage	Vulnerabilities	Steps to Ensure Transparency and Social Audit
9.	Payment of unemployment allowance [Responsibility: Programme Officer]	<ol style="list-style-type: none"> 1. Denial of unemployment allowance by wrongly accusing a person of not reporting for work 2. Late payment of unemployment allowance 3. Payment of unemployment allowance to the wrong person 4. Payment of unemployment allowance to non-existent (ghost) persons 5. Demand of bribe for paying allowance 	<ol style="list-style-type: none"> 1. A weekly public announcement of work allocation should be made, and work allocation orders must be displayed publicly 2. Payments should be made in a public place on fixed days to ensure that there is no ambiguity regarding payments. 3. All recipients and amounts of payment must be read aloud to ensure that the illiterate are not cheated, and also to check ghost payments. 4. A list detailing all payments to be made must be put up in a public and easily accessible place prior to the reading aloud of the list. 5. Provisions may be made to facilitate payments through the post office and other financial institutions. 6. The Gram Panchayat should automatically generate each week, in advance of the weekly meeting, a list of individuals eligible for receiving the unemployment allowance.
10.	Valuation of completed work [Responsibility: Sarpanch/PO/ Designated Agency]	<ol style="list-style-type: none"> 1. Taking and/or recording of improper measurements 2. Not consolidating the information regarding the works in one place 3. Issuing of false Completion Certificates 4. Works not conforming to specifications/standards 5. Data recorded in a confusing or incomprehensible manner 	<ol style="list-style-type: none"> 1. Verification of works, for conformity with the work order in terms of specifications and quality, must be carried out at an open 'project meeting' with all REGS workers who worked on that site, and open to all the people of the Gram Panchayat. 2. Completion data must be made public in a people-friendly format at this meeting. No Completion Certificate should be issued unless this open 'project meeting' has taken place and its observations have been taken into consideration. 3. An assessment of relevance of the work, along with appropriateness, must be carried out during this meeting as well as at the Social Audit Forum of the Gram Sabha.

No	Stage	Vulnerabilities	Steps to Ensure Transparency and Social Audit
			<p>4. Regular reports must feed into an audit and grievance redressal mechanism, and form part of the Block/District annual report.</p> <p>5. Comprehensive public hearings relating to works and individual entitlements must be held twice a year at the Gram Sabha level for all works completed in that period. The details of the requirements for this public hearing are given in the text.</p>
11.	<p>Evaluation of completed work [Responsibility: Sarpanch/PO/ Designated Agency]</p>	<p>1. Information not being made available because of a failure to carry out the transparency requirements as specified in the Guidelines and in the points mentioned above</p> <p>2. Failure to obtain entitlements due and failure to enforce accountability of officials; inability to get clarifications or answers to queries with regard to the Scheme</p> <p>3. Various aspects of the programme carried out without the people's involvement</p> <p>4. Failure of the grievance redressal mechanisms</p> <p>5. Lack of opportunity for individuals and the Gram Sabha as a collective to review the functioning of all aspects of the programme</p>	<p>1. Comprehensive public hearings to be called Social Audit Forums relating to works and individual entitlements must be held twice a year at the Gram Sabha level for all works done in the preceding period. The details of the requirements for this public hearing are given in the text.</p>

An effective Social Audit Forum requires careful attention to three sets of issues: (1) publicity and preparation before the Forum; (2) organizational and procedural aspects of the Forum; and (3) the mandatory agenda of an EGA Social Audit Forum. These

issues are taken up one by one in the next three sections.

2.10.1.1 Social Audit Forum: Preparatory Phase

The success of the Forum depends upon the open and fearless participation of all people, particularly potential beneficiaries of the programme. Effective public participation requires adequate publicity about the Forum as well as informed public opinion. This itself requires that people have prior access to information in a demystified form.

Publicity

The date, time, agenda, importance and sanctity of the Forum must be widely publicized so as to ensure maximum participation. The following measures will help:

- Provide advance notice of the date of the Social Audit Forum (at least a month in advance), and stick to an annual schedule in terms of the months in which these are held.
- Use both traditional modes of publicity (such as informing people through the beating of drums) as well as modern means of communication (such as announcements on microphones).
- Circulate announcements through notices on notice boards, through newspapers and pamphlets, etc.
- Conduct these audits in campaign mode so that the entire administration gears up to meet the institutional requirements of the Forum.

Preparation of Documents

The effective participation of people in a Social Audit Forum depends on full access to information. This is helped by easy access to all documents and information while the works are in progress. However, collating information and demystifying it is also an important part of preparing for a Social Audit Forum. For instance, summaries of the available information should be prepared in advance, so as to make it more intelligible. These summaries should be made available to the public in advance, and also read out aloud during the Social Audit Forum. Thus:

- ❖ All the relevant documents, including complete files of the works or their copies should be made available for inspection at the Gram Panchayat office at least 15 days in advance of the Social Audit Forum. There should be free and easy access to these documents for all residents of the Gram Panchayat during this period, and no fees should be charged for inspection. During this period, copies of the

documents should be provided at cost price, on demand, within one week of the request being made.

- * Summaries of muster rolls and bills must be prepared in advance for presentation at the Social Audit Forum. If possible, these summaries should be displayed on charts on the day of the Forum, and at the Gram Panchayat office during the preceding 15 days.
- * The original files should be available on the day of the Forum, so that any information can be cross-checked.
- * The works to be taken up for audit should be listed in advance, and the list should be put up on the notice boards, along with the other items on the agenda.

2.10.1.2 Social Audit Forum: Procedural and Organizational Requirements

Procedural Aspects

Sound procedures are essential for the credibility of a Social Audit Forum. Proceedings should be conducted in a transparent and non-partisan manner, where the poorest and most marginalized can participate and speak out in confidence and without fear. Care has to be taken that the Forum is not manipulated by vested interests. Towards this end:

- * The timing of the Forum must be such that it is convenient for people to attend—that it is convenient in particular for EGA workers, women and marginalized communities.
- * The quorum of the Forum must be the same as for all Gram Sabhas, with the quorum being applied separately to all relevant categories (e.g. women, Schedule Castes, Scheduled Tribes and OBCs). However, lack of a quorum should not be taken as a reason for not recording queries and complaints; social audit objections must be recorded at all times.
- * The Social Audit Forum must be chaired by an individual independent of the Implementing Agencies in the Panchayat. The meeting must not be chaired by the Panchayat President or the Ward Panch.
- * The Secretary of the Forum must also be an official from outside the Gram Panchayat.
- * The person responsible for presenting the information should not be a person involved in implementing the work. The vigilance committee members, or a

schoolteacher for instance, could be considered for the purpose of reading aloud the information as per the required format.

- * All officials responsible for implementation must be required to be present at the Social Audit Forum to answer queries from members of the Gram Sabha.
- * Decisions and resolutions must be made by vote, but dissenting opinions must be recorded.
- * Minutes must be recorded as per the prescribed format, by a person from outside the Implementing Agencies, and the minutes register must be signed by *all participants* at the beginning and at the conclusion of the meeting (after the minutes have been written).
- * The mandatory agenda (given below) must be gone through, including the transparency checklist. All objections must be recorded as per the prescribed format.
- * The 'action taken report' relating to the previous Social Audit Forum must be read out at the beginning of each Forum.
- * In addition, every District could bring in technical expertise (engineers and accountants) from outside the District to help prepare information for dissemination, attend selected Social Audit Forums and take detailed notes. Immediately after the Forum, they could visit the worksites and conduct detailed enquiries in cases where people have raised objections or testified that there is corruption.
- * The reports of these Social Audit Fora, and the reports of the technical team, should be submitted to the Programme Officer and the District Panchayat within a specified time frame for necessary action.
- * During the Social Audit Forum, the Right to Information Act and social audit manuals should be publicized so that the Forum serves as an ongoing training for the public vigilance process.

Institutional structures

The process of social audit will mainly be the responsibility of PRIs, with the Gram Sabha being involved in all decision making and in planning, monitoring and evaluation. The Sarpanch, the Gram Sewak, and the Gram Panchayat Secretary will be the critical functionaries. The Junior Engineer, the Project Officer and the Rozgar Sewak (as and when he/she is appointed) will also share the responsibility.

2.10.2 Social Audit Forum: Mandatory Agenda

‘Mandatory agenda’ refers to the minimum agenda of every Social Audit conducted by the Gram Sabha. The checklist below will help in reviewing whether the norms and provisions in the Act, Rules and Guidelines are being observed.

The mandatory agenda should include the following:

1. Whether the **process of registration** was conducted in a transparent manner:
 - * Was a list prepared by the Gram Panchayat of all the possible households that might seek registration?
 - * Was the first registration done in a special Gram Sabha conducted for the purpose?
 - * Was the list of registered persons read out for verification at the Gram Sabha?
 - * Is registration open in the Panchayat on an ongoing basis?
 - * Is the registration list regularly updated and put up on the Gram Panchayat notice board?
 - * Is there anyone remaining who wants to register, but who has not yet been registered?
2. Whether **job cards** were prepared, issued and updated in a transparent manner:
 - * Were job cards issued within one month of registration?
 - * Is the list of job cards regularly updated and put up on the Gram Panchayat notice board?
 - * Is a file containing photocopies of all job cards available for inspection in the Panchayat office?
 - * Was the job card issued free of cost, or was there a charge imposed for issuing the job card?
 - * Is there anyone who has not received a job card, or is there any other pending complaint?
3. Whether the **applications for work** are being treated as per the norms:
 - * Are workers receiving dated receipts for their application for work?
 - * Are people being given work on time?
 - * Is the allotment of work being done in a transparent manner, with lists of work allotments being put up on the Panchayat notice board for public notice and display?

- * Are those who have not been given work on time receiving unemployment allowance? How many people have outstanding payments of unemployment allowance, and are they being compensated for late payments as per the Guidelines?
- * There must be a reading aloud of a list of workers who have received unemployment allowance (if any) in the last six months, along with the amounts disbursed, and the basis for calculation of the amounts.
- * Are there any pending complaints about the receipt of work applications, the allotment of work and the payment of unemployment allowance?
- * Is the 33 percent quota for women being satisfied in the allotment of work?
- * Is the roster based on date of application received being followed for the allocation of work?
- * Are those who are allocated work outside the 5-km. radius being given a transport and living allowance equal to 10 percent of the minimum wage?

4. Transparency in the **sanction of work**:

- * Was the shelf of projects prepared in the Gram Sabha?
- * Was the technical estimate prepared by the Junior Engineer in consultation with residents of the village?
- * Were the works sanctioned from the shelf of projects as per the norms?
- * A list of all the EGA works sanctioned in the preceding six-month period must be read out aloud, along with the amount sanctioned and the amount spent on the works in the Gram Panchayat area.
- * Has the Gram Panchayat board been updated with the list of works painted on it?

5. Transparency in the **implementation of work**:

- * Were 'work orders' issued in a fair and transparent manner, with adequate publicity?
- * Was there a board on the worksite giving details of the sanctioned amount, work dimensions and other requisite details
- * Was an open 'project meeting' held before the commencement of the work, to explain the work requirements to the workers, including the labour and material estimates as per the technical sanction
- * Were the muster rolls available for public scrutiny at all times at the worksite?
- * Was a worksite material register maintained, along with verification by at least five workers whenever material came to the site?

- * Was a daily individual measurement of work conducted in a transparent manner where piece-rate norms were in force?
- * Was the final measurement of the work (for weekly wage payments) done by the Junior Engineer in the presence of a group of workers?
- * Did members of the vigilance committee make regular visits to the worksite and monitor the implementation of various aspects of the work?
- * Were any complaints made? Were they addressed within seven days by the grievance-redressal authority as specified in the Act?
- * Was an open 'project meeting' held within seven days of completion of the work, where all those who worked on the site, and residents of the village where the work took place, were invited to look at the entire records?

6. Wage payments:

- * Were wages paid within seven days?
- * Were wages paid at a designated public place at a designated time?
- * Were all payment details available for public scrutiny before the payments were made (through putting up muster roll copies on notice boards, etc.)?
- * Were payment details read out aloud in public while making payments?
- * Were payments made by an agency other than the one implementing the work?
- * Was a record maintained of payments made beyond the specified time limit?
- * Was compensation given as per the provision of the Payment of Wages Act, 1936 for late payments?
- * Are any wage payments still due?
- * Have there been any instances of workers earning less than the minimum wage, and if so, why?

7. Post facto auditing of the records and accounts of each work undertaken:

- * Does the file have all the documents required
- * Were all the documents available for scrutiny at least 15 days before the Social Audit Forum?
- * Were charts of the summary sheets available for public display and scrutiny before and during the Social Audit Forum?
- * The muster roll summary must be read out aloud to check for discrepancies
- * The summary of the bills must be read out aloud to check for discrepancies
- * The measurement book summary must be read out aloud.

- * The photographs taken before, during and after the work must be available for public display and scrutiny during the Social Audit Forum.
- * Was the vigilance committee formed as per the norms?
- * Has the vigilance committee submitted its report?
- * Sections of the vigilance committee report that deal with the following aspects of work should be read out aloud in order to form the basis of discussion in the Gram Sabha:
 - quality of work
 - work dimensions
 - selection of location
 - whether minimum wages were paid
 - whether wages were paid on time
 - whether all bill payments have been made
 - whether any complaints were made to them during the work
 - what redressal has taken place regarding complaints or grievances
 - whether prescribed worksite facilities were made available;
 - what maintenance the project requires.

8. Other general issues connected with EGA works:

- * General maintenance issues relating to development works in the Gram Panchayat should also be noted and discussed at the Social Audit Forum.
- * A list of incomplete works and works not in use should be prepared by the Gram Panchayat Secretary and presented before the Forum for consideration and corrective action.
- * The last financial audit report should be made available to the Social Audit Forum, and audit objections, if any, should be read out aloud.
- * Any Utilization Certificate (UC) or Completion Certificate (CC) issued since the last Social Audit Forum should be read out aloud.
- * If wages or unemployment allowances are due to anyone, the dues should be listed and reported to the Programme Officer for necessary action.
- * The Forum provides an opportunity to check whether all the boards in the Gram Panchayat have been updated as per the requirements.
- * The services of the EGA staff like the Gram Rozgar Sevak, the Junior Engineer and any other staff can also be audited for quality of service.
- * The timely flow of funds from the Programme Officer to the Gram Panchayat should also be monitored.

2.11 Management of Data and Maintenance of Records

The entitlements under the Act are legally justiciable. For this reason, among others, it is important to maintain accurate records of all aspects of implementation. This is also required by the Right to Information Act, 2005. This chapter indicates which records and data must be maintained; formats are given in the Annexures.

The maintenance and timely updating of information will require a comprehensive computerized Monitoring and Information System (MIS). The Centre will develop a core MIS for this purpose, and the States may make suitable additions to suit their respective needs.

2.11.1 Records to be Maintained by the Gram Panchayats and Other Implementing Agencies

1. **Application Registration Register:** Every Gram Panchayat shall maintain a register of applications (or requests) received for registration. This should contain the name of each applicant, the date of receipt of application or request, and the date on which the job card was issued. A proforma is given in Annexure B.7.
2. **Job Card Register:** Every Gram Panchayat shall maintain a job card register. A duplicate of this register will be maintained in computerized form at the office of the Programme Officer. A proforma is given in Annexure B.8.
3. **Employment Register:** Every Gram Panchayat shall maintain a register that records: (a) employment demanded; (b) employment allotted; and (c) employment actually taken up. A proforma for this register is given in Annexure B.9.
4. **Asset Register:** Every Gram Panchayat and every Implementing Agency shall maintain a register of all works sanctioned, executed and completed in the proforma given in Annexure B.10. The information in the register will be reported by the Gram Panchayat and all other Implementing Agencies to the Programme Officer on the same proforma. The Implementing Agencies that are executing works within the jurisdiction of more than one Programme Officer shall send the data on the same proforma to the District Programme Coordinator.
5. **Muster Roll Receipt Register:** Gram Panchayats and Implementing Agencies shall maintain a muster roll receipt register based on the proforma given in Annexures B.5 and B.6 respectively. The Gram Panchayat shall also maintain a record of the copies of muster rolls received from other Implementing Agencies.
6. **Muster Rolls**

* Muster rolls each with a unique identity number will be issued by the

Programme Officer to the Gram Panchayats and all Executing Agencies.

- * Muster rolls will be maintained by the Gram Panchayats and other Executing Agencies. They will contain, inter alia, the following information for each work:
 - Name of the person on work; his or her job card number; days worked and days absent; and wages paid. The payment made and the number of days worked will be entered in the household job card of every worker.
 - Unique identity number given to that work
 - Signature or thumb impression of the payee
- * The original muster roll will form part of the expenditure record of the Executing Agency.
- * A photocopy of the muster roll will be kept/sent for public inspection in every Gram Panchayat and in the office of the Programme Officer.
- * Muster rolls should be digitized at the Programme Officer level, and if possible at the Gram Panchayat level.
- * Any muster roll that is not issued from the office of the Programme Officer shall be considered unauthorized.

7. **Complaint Register:** Complaint registers shall be maintained at all the Panchayat levels.

2.11.2 Records to be Maintained by the Programme Officers

1. **Employment Register:** Every Programme Officer shall maintain a register of applications for employment received by him. All such applications shall be recorded in the register and forwarded to the concerned Gram Panchayat. Copies of the application shall be retained at the office of the Programme Officer.
2. **Job Card Register:** Duplicate copies of the job card register from every Gram Panchayat will be maintained in computerized form at the office of the Programme Officer.
3. **Muster Roll Issue Register:** The Programme Officer will maintain a register to keep track of the muster rolls issued to the various Implementing Agencies
4. **Asset Register:** Gram Panchayats and other Implementing Agencies will forward the information recorded in their asset registers to the Programme Officer on the same proforma. The Programme Officer will compile the data in computerized form and supply a copy to the District Programme Coordinator.

5. **Complaint Register:** The Programme Officer will maintain a complaint register. The Programme Officer should also install a complaint box at a conspicuous place at his/her office and personally open it at regular intervals. The complaints received in such boxes should be entered into the complaint register.

2.12 Grievance Redressal

1. The Programme Officer will be the Grievance Redressal Officer at the Block level, and the District Programme Coordinator at the District level.
2. A system of appeal will be designed to deal with grievances at each level. Appeal against the Gram Panchayat will be to the Programme Officer. Appeal against the Programme Officer will be to the District Programme Coordinator. Appeal against the District Programme Coordinator may be with an appropriate authority designated by the State Government.
3. Name and address of the petitioner, and nature and date of the petition, are to be entered in a register which will be uploaded on to the internet on a weekly basis.
4. The person making the grievance is to be given a receipt with number and date so that he or she can follow up the status of disposal of his grievance from a counter in the office of the Programme Officer and over the internet using the receipt number.
5. Once a grievance has been disposed of, the date and nature of disposal should be communicated to the petitioner. These details are to be made available over the internet.
6. All grievances will be disposed of within the time limit prescribed in the Act.
7. Grievance redressal performance of all authorities under the Act and these Guidelines are to be posted on the internet on a weekly basis.
8. Action taken on the complaints received by the Programme Officer and the District Programme Coordinator shall be placed before the meetings of the Intermediate Panchayats and District Panchayats respectively.
9. Whoever contravenes the provisions of this Act shall on conviction be liable to a fine which may extend to one thousand rupees.

2.13 States can also implement their own Acts

The NREGA has a special provision that allows state governments to implement their own Acts but under very specific conditions only:

"Provided that where a State enactment exists or is enacted to provide employment guarantee for unskilled manual work to rural households

consistent with the provisions of this Act under which the entitlement of the households is not less than and the conditions of employment are not inferior to what is guaranteed under this Act, the State Government shall have the option of implementing its own enactment"

References

1. The text of the National Rural Employment Guarantee Act 2005 is available at <http://rural.nic.in/rajaswa.pdf>
2. The NREGA guidelines are available at http://nrega.nic.in/Nrega_guidelines.pdf

3 Basic Concepts of Watershed Development and Earthen Engineering

The NREGA emphasises water conservation work. It also insists on preparation of an overall plan within which these works are to be undertaken. Our view is that works connected with water should follow a watershed approach. This is also the view of many state governments implementing the REGS. Hence, it is important to begin with an understanding of watershed development and the basic concepts involved in this approach. These include not just technical concepts but also the social considerations that must inform our plan. This chapter outlines some of the technical aspects. The next chapter deals with the social issues in detail.

3.1 Water

3.1.1 What is a Watershed?

The area where a river “catches” its water is called its **catchment** or **watershed**. A watershed can be visualized as a landscape shaped unevenly like a bowl or basin. When it rains, water flows down from the top of

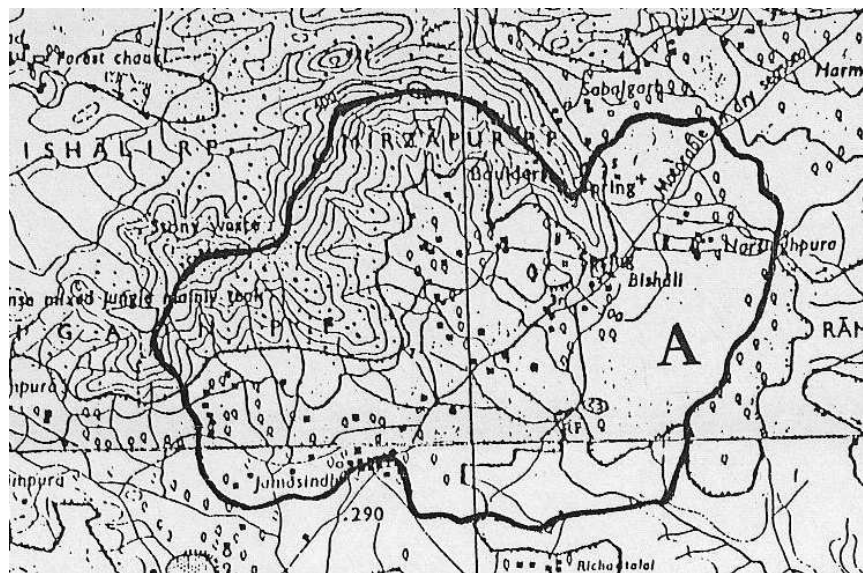

Figure 3.1: A watershed demarcated on a toposheet

this bowl to collect at the bottom. The undulating land area of any region forms several such units, each of which are called watersheds. Water within each of these units drains to a common point. So the hills, valleys, forests and fields that encircle the falling rain and guide it into streams and then rivers, all form the enclosure that is a watershed.

The top of a watershed from where the slopes start is called the **ridge**, because it

is the dividing line that partitions one watershed from another. Ridges demarcate the region into distinct areas that ‘catch the rain’ for a stream or river.

In a watershed, the slopes falling from the ridge to the beginning of the plains are called the **ridge area**. The many channels that flowing rainwater drains into are called **drainage lines**. Gullies, streams and rivers are all drainage lines. The difference between a gully, a stream or a river, is the size of its catchment area. That is, the larger the expanse of land that collects and drains water into a channel, the bigger the stream of water will be. The size of a watershed may vary from a few hectares to thousands

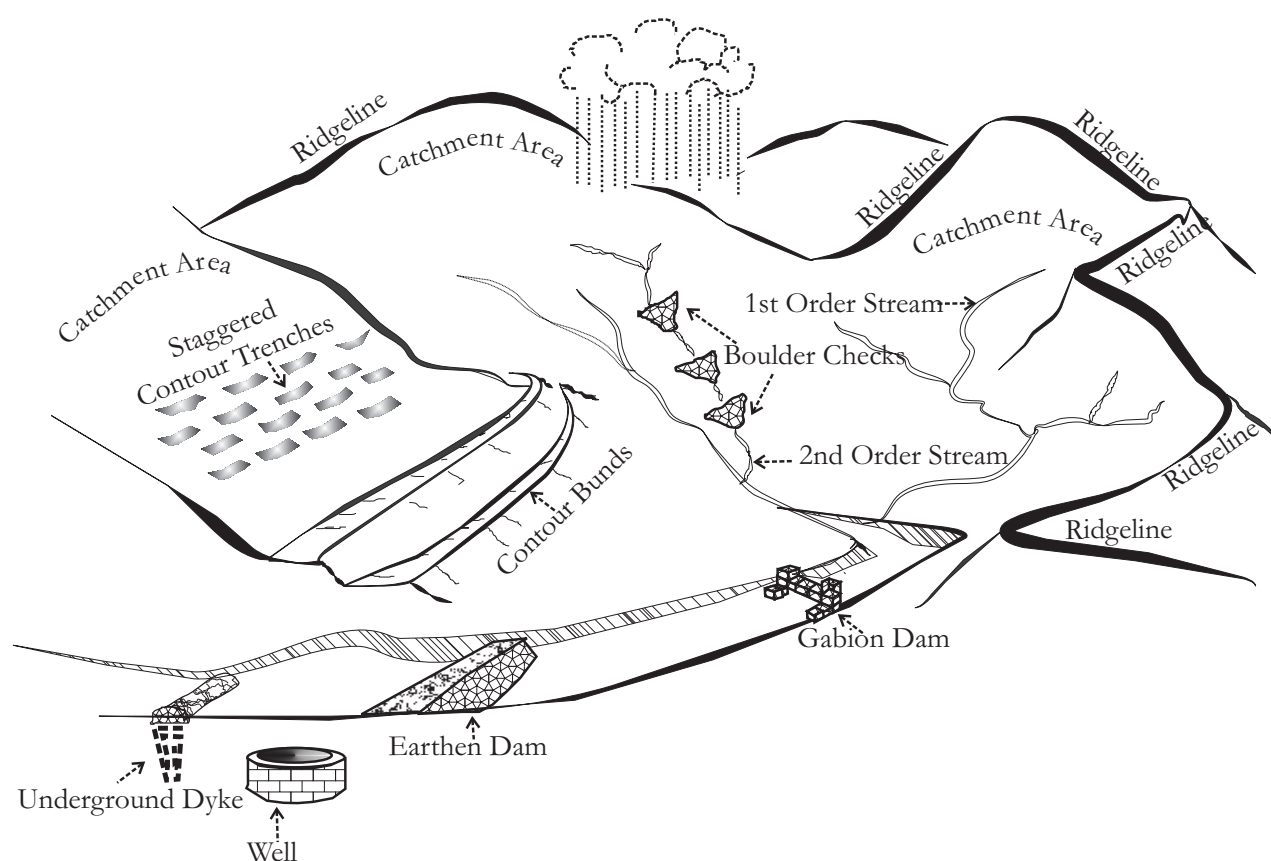

Figure 3.2: The ridge line separates one watershed from another. In different parts of the watershed, interventions are carried out on the principle of location specificity

of square kilometres. Table 3.1 provides a system of classifying watersheds at different levels of aggregation.

We, thus, have a progressive series of ecological units, each a watershed at a particular level of aggregation (with a corresponding scale in mapping terms). While planning exercises need to be conducted at each level, the actual execution is usually done within the **milli-watershed**. A unique feature of the watershed approach is that it is very location-specific. Within a milli-watershed, there can be very different conditions in

Table 3.1
System of Classification of Watersheds in India

Category	Number	Size Ranges ('000 ha.)
Regions	6	25,000-100,000
Basins	35	3,000-25,000
Catchments	112	1,000-3,000
Sub-Catchments	500	200-1,000
Watersheds	3,237	50-200
Sub-watersheds	12,000	10-50
Milli-watersheds	72,000	1-10
Micro-watersheds	400,000	0.5-1

Source: Bali (1979, p. 82)

terms of soil, slope, vegetation etc. Watershed interventions vary according to the variations in each of these. This is why watershed plans have to be made at the village level and not imposed from above. This is precisely the thrust of the NREGA.

3.1.2 Drainage Systems: *Naali, Naala, Nadi*

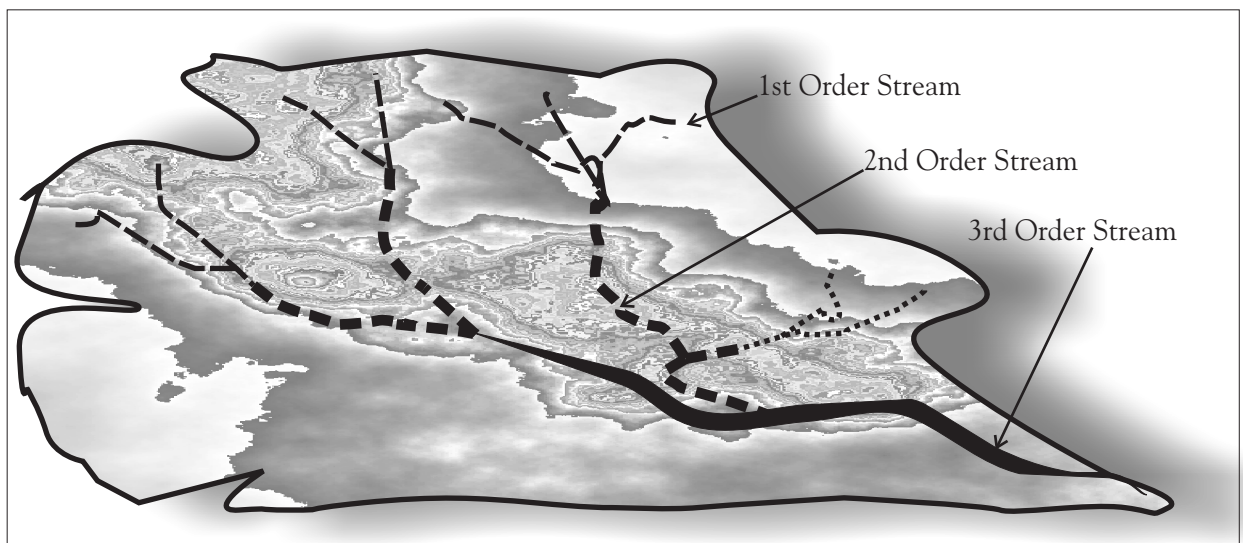

Figure 3.3: Streams of different orders

As is obvious from the definition of a watershed given above, watersheds can be defined at various levels, each level being contained within each successive higher level. The water flowing through a number of gullies joins up to make a *naali*, (a small stream), many *naalis* combine to make a *naala*, (a larger stream), *naalas* flow into a *nadi* (a river) and so on. Different watershed interventions take place in different sized drainage lines.

The size of the catchment defines the drainage line. The smallest stream is called the first order stream. Two 1st order streams join to make a 2nd order stream. Similarly, two 2nd order streams join to make a 3rd order stream and so on.

3.1.3 Why Watershed Development?

Typically in our country, rain falls very intensely within a few hours, within a few days, within a few months of every year. The number of rainy days does not average more than 40-50 days in most parts of the country. The challenge is to find ways of using this water where it falls. For years, our planners have allowed the rain which falls in every village of our country to flow out into the rivers as runoff and then tried to bring this water back to the villages by building large and expensive dams and canal networks. The aim of watershed development is to precisely reverse this process. The aim is to stop and conserve water where it falls, within every village, under the direction of the village watershed committee, so that it can be used for a longer period of time.

Our approach must be guided by the *principle of balance*- whatever we draw from mother earth, we must return to her. We must also observe a strict hierarchy in prioritising the uses to which we put this water guided by the principle: *the needs of the neediest first, sufficiency for all before superfluity for some*.

Watershed development tries to reduce the volume and velocity of runoff through a series of interventions. The aim is to make the water walk, rather than let it run; to make the water walk vertically down rather than run horizontally across the village.

The simple methods of stalling rainwater from running off have an enormous impact on the overall health of the watershed. Since rainwater is intervened at regular intervals by watershed structures, it does not flow long distances. Therefore, it cannot gather speed, volume and force. As a result:

1. **Soil erosion is reduced**, as the water does not gain enough momentum/force to scrape off topsoil.
2. **Silt is trapped** at regular intervals. Whatever silt is carried by the water flow reaches a dead end when the water collects in small trenches and bunds. This, in turn, reduces the rate of silt piling up in water harvesting structures that have been constructed in the lower reaches of the watershed.
3. **Groundwater increases**. By slowing down the flow of water on the surface, we increase the possibility of water percolating into the ground. This raises the water table.
4. **The life of rivers and storages is prolonged**. Water that has been caught in the ridge -area, trickles down slowly, increasing the duration of flow in the drainage lines. The capacity of the water harvesting structures created downstream on the

drainage line is also utilised more fully as they get many more refills.

5. **The local soil moisture profile improves.** This provides greater sustenance to vegetation or biomass.

3.1.4 The Water Cycle

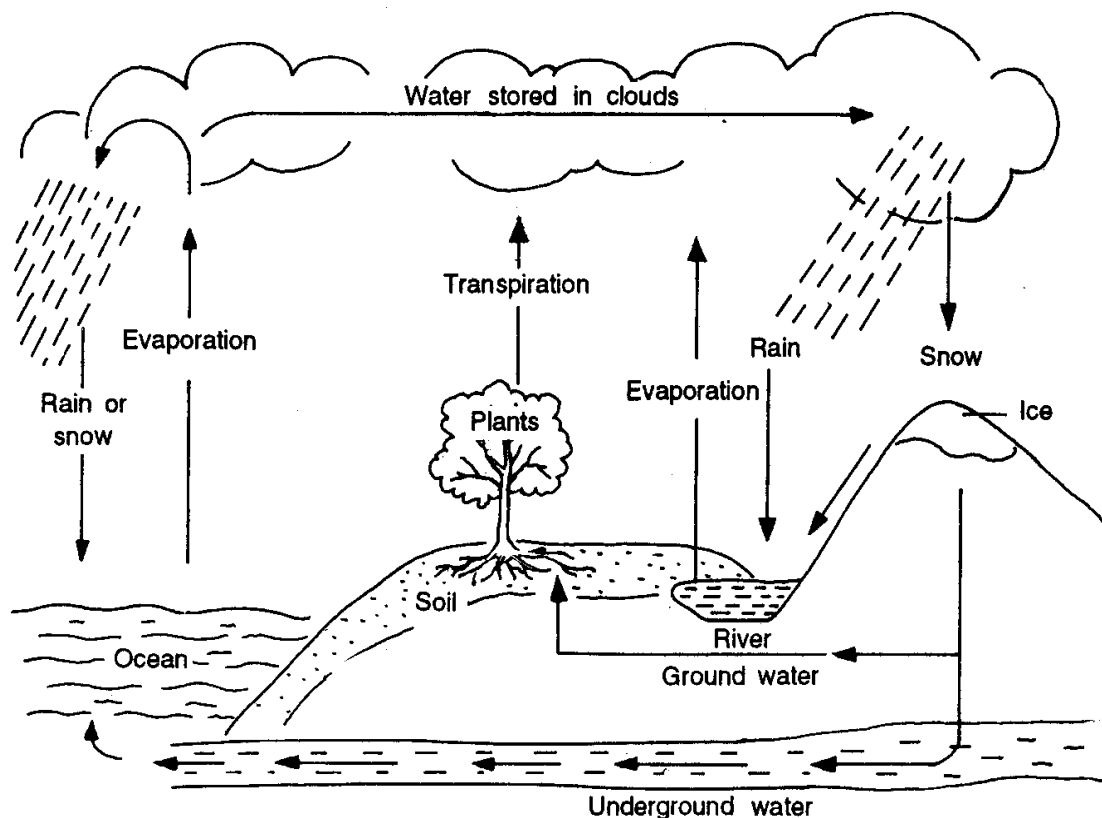

Figure 3.4: The water cycle

Water rises from the ocean to the sky, falls back on land as rain, flows into the ocean, and again vaporizes back to the sky. This unending rotation of moisture is called the water cycle. We have seen this cycle go on and on all our lives with no beginning or end. But, from rain to becoming a cloud again, many things happen. The things that happen to rain water can be captured in what is called the **Water Balance Identity**.

3.1.5 Water Balance Identity

Rain or **precipitation (P)** that falls is partly absorbed by the surface of the soil and is held as **stored soil moisture (ST)**. The water that flows over the land is called **surface runoff (RO)**. Part of the rain that percolates into the soil goes deeper and merges with the stock of groundwater as **groundwater recharge (GW)**. **Evaporation**

(E) takes place from all wet surfaces exposed to the atmosphere. Plants drink up a portion of soil moisture for their consumptive use and ultimately **transpire** it to the atmosphere while producing biomass. In areas with vegetative cover, water movement into atmosphere takes place both from the leaves (transpiration) and from the wet surface below vegetation (evaporation). It is difficult to separate the two. The combined impact of this evaporation and transpiration is called **evapo-transpiration (ET)**. The **water balance identity** can therefore, be written as,

$$P = E + ET + RO + GW + ST$$

3.1.6 Rainfall

Since the primary concern of watershed development is to “catch the rain”, we have to understand the nature of rain. How much of it falls? How fast does it fall? How is rain measured?

Measuring Rain - Rainfall is measured all over the world in millimeters or inches. Rain falling onto any point on a horizontal surface accumulates to a certain height. If this height is 10mm, then it is said that the ‘**depth**’ of rainfall is 10 millimeters (‘depth’ or ‘height’ here is just a point of view - we always look at water from above, rarely from below, so ‘depth’ it is for rainfall too). We can see for ourselves that if we left flat bottomed, cylindrical beakers of different diameters out in the rain, water would fill up to almost the same level in them. **Volume of Rain Received in a year**- How much rain an area receives in a year is easily calculated by multiplying the annual rainfall with the area over which it falls. This gives us the volume of rain in cubic meters.

$$\text{Volume of Rainfall in cubic metres} = \text{Rainfall in meters} \times \text{Area in square metres}$$

For instance if our watershed has an area of 1000 hectares and the region receives an average annual rainfall of 600mm, we can calculate the volume of rainfall received in our watershed area using this formula. For this first convert both rainfall and area into metres.

$$\text{Since } 1,000 \text{ mm} = 1 \text{ m, therefore } 600 \text{ mm} = 0.6 \text{ m}$$

$$\text{Also we know that } 1 \text{ hectare} = 10,000 \text{ sq.m}$$

$$\text{Thus, } 1,000 \text{ ha} = 1,000 \times 10,000 = 1,00,00,000 \text{ sq.m}$$

Thus, Volume of rainfall our watershed receives in a year

$$= 0.6 \text{ m} \times 1,00,00,000 \text{ sq.m} = 60,00,000 \text{ cu.m.}$$

But, it is not enough to know how much rain falls in a year. We have to know how fast it will fall – how much rain will fall at one go - in a day, in an hour, in a second! It

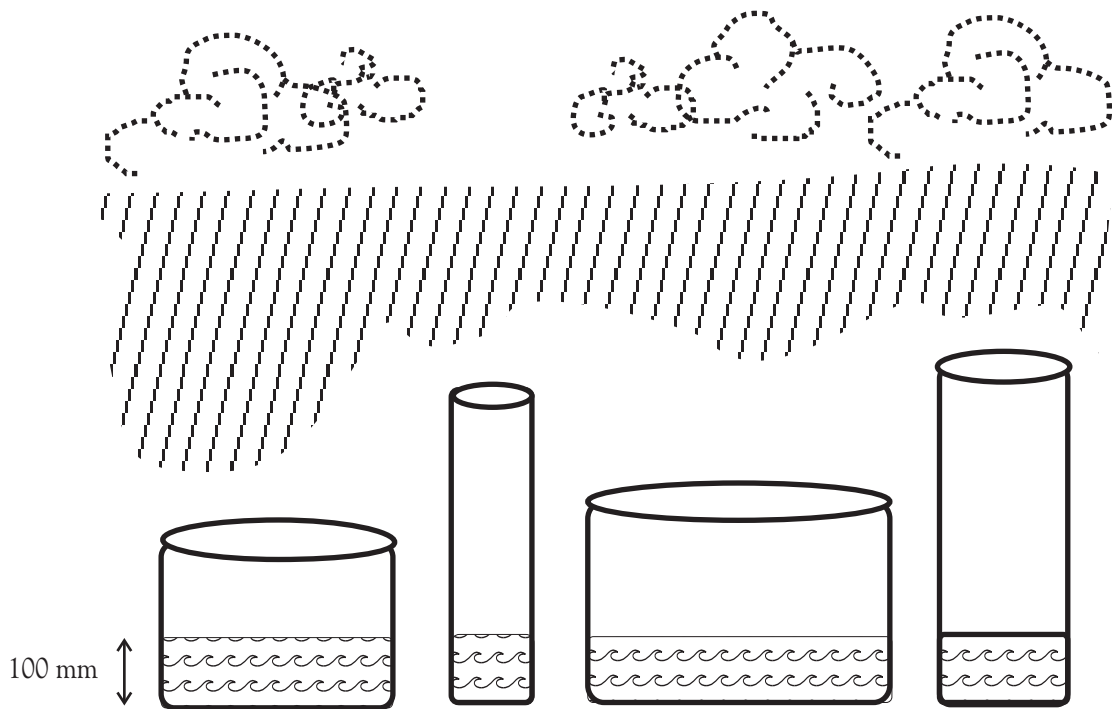

Figure 3.5: The depth of rainfall will be the height to which water will collect in any flat bottomed container

is like the municipal water supply - we have to be prepared with our buckets to catch it because we know that the entire day's water will only come for an hour.

Intensity of Rain – So the crucial part is to know how much rain will fall and how fast it will fall in **one time-period**. It may rain for days on end, or just for an hour. This is known as the intensity of rainfall and is expressed in 'millimeters per hour' (remember here that we have to keep converting this into 'meters per hour' most of the time).

Knowing the intensity of rainfall has a critical bearing on the size of the structures we design. It is just like uncertain municipal water supply. It may come for 10 minutes or an hour - if one does not have enough buckets to store all of it in, tap water runs down the drain. Similarly, the capacity of watershed structures is designed to catch as much of the rain that is 'supplied' or falls at one time.

3.1.7 Runoff (RO)

As we have seen in the water balance identity, a lot happens to rain. Rainfall is intercepted by foliage before it reaches the ground. The water that remains to flow on the surface of the land, after being soaked up by the soil or taken up by plants, is called the surface run-off. It is the water that we can see on the ground when it rains - sweeping and swirling, soaking our feet, making puddles and rivulets, gurgling down streams.

3.1.8 Co-efficient of Run-off (C)

The quantum or volume of rain that will actually flow as “run-off” on the surface will be less than the total rain that fell. This will mainly depend on the kind soil on which it falls, nature and extent of vegetation there is on the land (land-use type) and the slope of the land. This drag placed on flowing water is sought to be captured by what we call the **Co-efficient of Run-off (C)**. Where the lay of the land is such that a lot of the rain that falls, also runs off the surface, the co-efficient of run-off is said to be high. This will be in impermeable soils, with high slopes and low vegetative cover. On the other hand, if the land flat, the soil is permeable and there is a lot of green cover on it, the co-efficient of run-off will be low. To put it simply, if a hundred buckets of rain have poured from the skies and forty buckets flow off the ground, then the co-efficient of run-off is:

$$\frac{40 \text{ buckets}}{100 \text{ buckets}} = 0.4$$

Thus, the co-efficient of run-off is a percentage, which tells us how much of the rain will run off the surface. For the same kind of soil and land-use, if the slope is higher, the value of C will rise. Again for the same slope and same soil, higher the green cover, the lower will be the value of C. And so on. This is captured in Table 3.2

Table 3.2: Factors Influencing Runoff Coefficient

Condition	Impact on Runoff Coefficient	
1. Soil Permeability:		
More		▼
Less	▲	
2. Slope:		
More	▲	
Less		▼
3. Soil Condition:		
Dry		▼
Wet	▲	
4. Vegetative Cover on Ground		
More		▼
Less	▲	
5. Spacing between plants and between rows of plants (Intensity of Vegetative Cover)		
More	▲	
Less		▼
6. Types of Agricultural Work:		
Depth and amount of ploughing (and other agricultural activities)	?	
Intercropping		▼
Contour Farming		▼

All these factors have, of course, to be taken together. Table 3.3 gives the standard coefficients used for estimating runoff. To take only one example, Table 3.3 shows that if the land is cultivated, its slope is 10-30% and the soil is silty clay, then the co-efficient of run-off will be 82%.

Table 3.3
Coefficients for Estimating Runoff

Land Use & Slope	Sandy Loams	Clay/Silty Loams	Silty Clay
<i>Cultivated Land</i>			
0 - 5%	0.30	0.50	0.60
5 - 10%	0.40	0.60	0.70
10 - 30%	0.52	0.72	0.82
<i>Pasture Land</i>			
0 - 5%	0.10	0.30	0.40
5 - 10%	0.16	0.36	0.55
10 - 30%	0.22	0.42	0.60
<i>Forest Land</i>			
0 - 5%	0.10	0.30	0.40
5 - 10%	0.25	0.35	0.50
10 - 30%	0.30	0.50	0.60

Source: Dhruvnarayana, 1993

3.1.9 Annual Volume or Quantum of Run-off in a Watershed (Surface Water Yield)

Therefore it is clear that if we want to calculate the annual rain that will run-off a certain area, we will need to multiply the annual rainfall with the area on which it falls and the coefficient of run off for that area.

$$\text{Thus } Q = C \times R \times A$$

where Q = annual volume or quantum of surface run-off (in cubic meters)

C = is the co-efficient of run-off

R = is the annual rainfall (in metres) and,

A = is the area on which the rain falls (in square meters)

This is also known as the **surface water yield** of a watershed

3.2 Soil

3.2.1 Introduction to Soils

People started building with earth around 10,000 years ago. There is no country in this world that does not have a tradition of building with earth. Homes, dams, fortresses, granaries, cities, roads - the technology of using earth as a construction material has evolved and refined over the ages all over the world. Following the Industrial Revolution,

however, steel and cement dominated construction in the 20th century. But over the last 2-3 decades, realisation is growing about the unsustainability of development paradigms based on the use of fossil fuels. The speed with which global warming is beginning to affect life on earth is opening up the space once again for eco-friendly technologies. In earlier times earth was the most sensible, economical and efficient choice – it was right there to use. Today it has become almost like having no other choice. The world has nearly used up all its endowments – wood, coal, petroleum, iron – and jumped headlong into an energy crisis. So we are back to building with earth.

The appropriateness of using earth to make water harvesting structures is that it is available right there, it can be shaped into anything by human beings and it does not cost much. In other words, it is a material that does not have to be transported by vehicles, or worked on by machines or made in factories. So it stands, free from a fossil-fuel based economy, accessible to the poor, sustainable rather than destructive.

3.2.2 Origin

It may seem hard to believe that the soil we walk on, which we can pick up and crumble in our hands, is a most complex thing formed over centuries, through vast processes of disintegration, decomposition, displacement and deposition. The infinite variety and characteristics of soils arise from the kind of **parent rocks** from which they were formed. Some differences also arise because of variations in the kind of **plants** that grew in the soil. When they died, these plants added **organic substances** to the soil. These substances in turn, were the food for a vast population of **micro-organisms** and even **animals** which inhabited the soil. Thus, a soil is composed of millions of ‘individual’ particles, each of which has elements derived from each of these sources. But no soil is a pure lump of such particles. It is a mixture or an aggregate of different particles. The different sizes and shapes of these particles put together create voids and channels. The geometry of these spaces or pores that are filled with water or air, also contributes to the properties of the soil.

3.2.3 Texture

What soil feels like is the ‘texture’ of soil. This is a result of the mixture of different sized particles. Different soils have different combinations of these particles. We can roughly make this out even by feeling the soil with our fingers. Thus, soils with more sand are coarser and those with more clay feel finer. The relative proportions of different constituents in a soil give the soil its texture. Particles above 2mm in diameter are strictly speaking not regarded as part of soil. These are classified as stones and gravel. See Table 3.4 and Figures 3.6 and 3.7

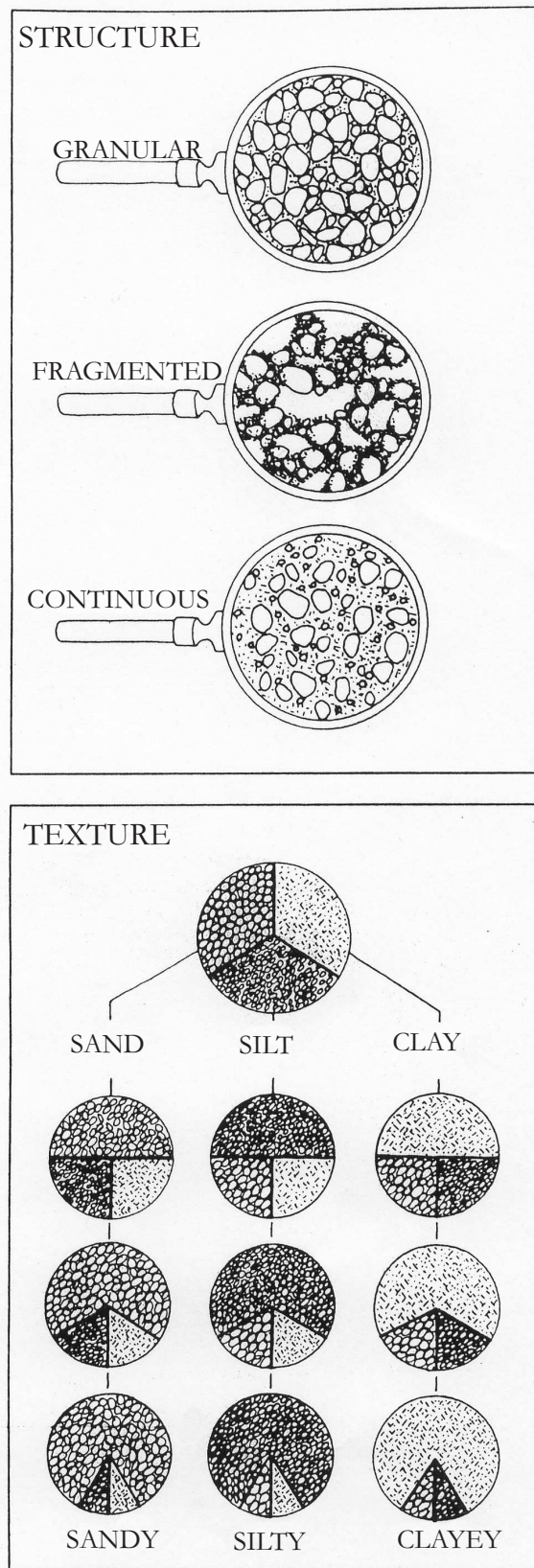

Figure 3.6: Soil Structure and Texture

Table 3.4
Particle Sizes of Constituents of Soil

Material	Particle Size (mm)
Stones and Gravel	> 2
Coarse Sand	2 - 0.2
Fine Sand	0.2 - 0.02
Silt	0.02 - 0.002
Clay	< 0.002

Source: Khanna, 1996

3.2.4 Soil Structure

The way in which the different particles group or stick together in soils, forming a network of pores and channels is known as **soil structure**. It describes what can be called the **architecture** of the soil - how the building blocks of soil are arranged and how will they behave when subjected to water, air or force. There are three main types of soil structure:

Granular- when it is like gravel, separate lumps with no bonding between them

Fragmented- when it is crumbly, small lumps loosely bonded by clay

Continuous- when it is like dough, all the particles are held by a mass of clay

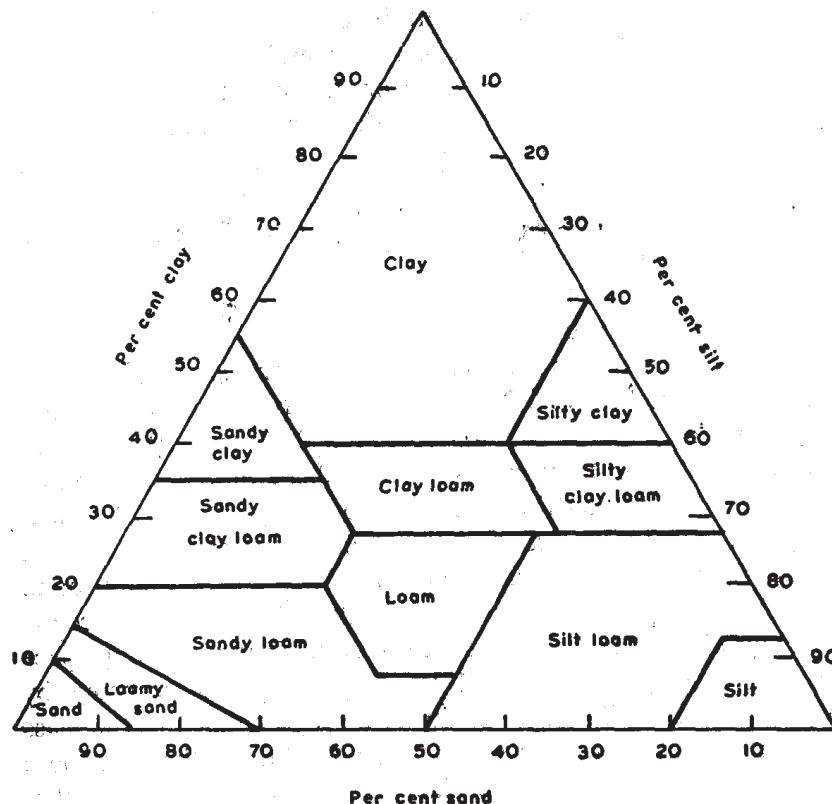

Figure 3.7: The composition of soil can also be understood from this triangle

Source: Russell, 1975

3.2.5 Fundamental Properties of Soil for Construction

When constructing with soil we need to be aware of five basic properties. These properties affect how earth behaves on being mixed with water and how earthen structures stand up to the pressure of water on them.

Texture – the proportion of different grain sizes, gravels, sands, silts, clays. The part forming the largest portion of the mix determines other properties

Infiltration Capacity – is the ability to allow water to pass through. Water just passes through gravels and sands. It takes time or does not pass through clay at all. Infiltration capacity has a bearing on soil erosion, how much runoff there will be, whether water will percolate into the ground from a reservoir, whether the dam will get seeped in water and so on.

Plasticity – the ease of giving it a shape. Plasticity is the ability of the soil to submit to deformation without elastic failure. For example, clay can be shaped into anything and sand cannot.

Compactibility – the ability to be compressed and reduce its porosity. When soil is subjected to a force, like a hammer or road roller, it compresses. The air is pushed out of the pore spaces and they collapse. Smaller grains shift to fill up these spaces. So, as the ratio of voids decrease, the density of the soil increases making it difficult for water to pass through.

Cohesion – is the capacity of the grains in the soil to remain together under a tensile stress or force that is trying to pull them apart.

These soil properties also have a fundamental bearing on selection of materials for construction as well as on the design characteristics of structures using different soils. Thus, structures made of finer materials will have flatter slopes than structures made of coarser materials, all other conditions being the same. Finer materials will generally be placed towards the middle of structures, while coarser materials will be placed on outer surfaces, especially those coming into contact with water.

3.2.6 Soil Erosion

Soil erosion is defined as the detachment and transportation of soil particles by natural agents like water and air. Soil erosion depends on the type of soil, extent of vegetative cover, intensity of rainfall and topography. Sandy soils have larger particle size but lower cementing between particles. Hence, they can be detached easily from one another but it is difficult for running water to transport them. On the other hand, particles of clayey soils tend to flock together, making them less detachable. However, once detached from each other, these lighter particles are easily carried away by running

water. Clayey soils are, hence, considered highly erodable. One of the main aims of the work to be done under NREGA is to reduce the rate of soil erosion. Soil erosion has degraded nearly 51% of India's geographical area. It is estimated that about 5334 million tonnes of soil (16.35 tonnes/ha) are eroded annually in India. Of this, nearly 30% (1572 million tonnes) is lost into the sea forever and another 10% gets deposited in reservoirs of dams, resulting in the loss of their storage capacity.

3.3 Earthen Dams

3.3.1 Determining the Storage Capacity of a Water Harvesting Structure: Social and Technical Considerations

One of the aims of any watershed programme is to capture this water through different water harvesting structures. However, we must remember that neither is it possible nor is it desirable to harvest all the water that falls in a watershed. It is not generally possible because rain falls with great intensity in bursts (storms). All of this water is very difficult to capture within the watershed through the small dams we build in our programme.

Also we must bear in mind that some of this water must be allowed to flow downstream for use in the villages there. By capturing all of it within our watershed we could be depriving downstream people of this water. Unfortunately in mainstream engineering there is a notion of "water wastefully flowing into the sea". Ecologists have taught us that this is a fundamentally flawed notion. All water flows help sustain different forms of life and the balance within the eco-system (including the monsoon cycle itself). Thus, the idea of reducing "water losses" to zero must be given up.

We must also recognise that even more than harvesting rainwater, the critical issue is of sustainable and equitable use of this water. Thus, groundwater exploitation has to be legally and socially restricted and the cropping patterns in agriculture attuned to the agro-ecological conditions of each area. This theme is explored further in the next chapter.

There is also the issue of whether even our small dams cause submergence of anyone's land in the village. If so, there has to be an adequate compensation package worked out in a participatory manner. These people must become the first claimants of benefits from the dam. Attempts should be made to provide them other land in the village.

We know that each water harvesting structure has a certain size depending on where it is located and the area of its catchment. This catchment area is the area from which the structure tries to catch its water. The design of any water harvesting structure is

based on knowing the quantum of runoff that might be expected from its catchment area within a certain period of rainfall. We have to match this volume with the storage capacity of the structure. Remember that during a year or a season, rain occurs in several spells and hence runoff always comes in instalments.

Thus, designed storage capacity of a structure usually tries to catch the runoff in instalments. This is because if we design structures to capture the rain of the entire season, we will end up "over-designing" them. That is, we may end up building a structure that never gets filled up. Therefore, what we do is to design the structure to capture only a certain percentage of the total annual rainfall. Naturally, this percentage is higher for larger structures and lower for smaller ones. We examine the historical data for rain in our area. We then try to arrive at the maximum rain that is "most likely" to fall in a spell. For a larger structure like an earthen dam, this "spell" will refer to a longer period of time (like a month); for a contour trench it will refer to something like a day. The thumb rules devised to arrive at these percentages are given in the respective chapters in this manual.

3.3.2 Peak Runoff

Not only does rain fall in instalments, these spells of rain can vary greatly in intensity. There may be a sudden storm and dangerous amounts of water may have to be dealt with. This brings us to a very important insight. Watershed development is not merely about capturing rain water, it is also about providing a safe passage for water out of the structure. This is particularly important during intense storms when a safety valve is required that lets some of the runoff go. This is especially important in earthen structures where the absence of such a safety valve would lead to water flowing over the top of the structure. This would definitely break the dam.

Therefore, we want to give water a way out through an outlet as soon as our structure has filled up. For this we have to calculate the fastest rate at which runoff can occur. This is called **peak runoff**. Simply, peak runoff is the maximum rate of runoff expected from a catchment and is usually measured in cubic meters per second. All this explained in detail in the earthen dams chapter.

3.3.3 Natural Angle of Repose

A heap of gravel or sand or clay, left to lie on the ground settles into a pile. The natural incline that the sides of this heap form with the ground is called **the natural angle of repose**.

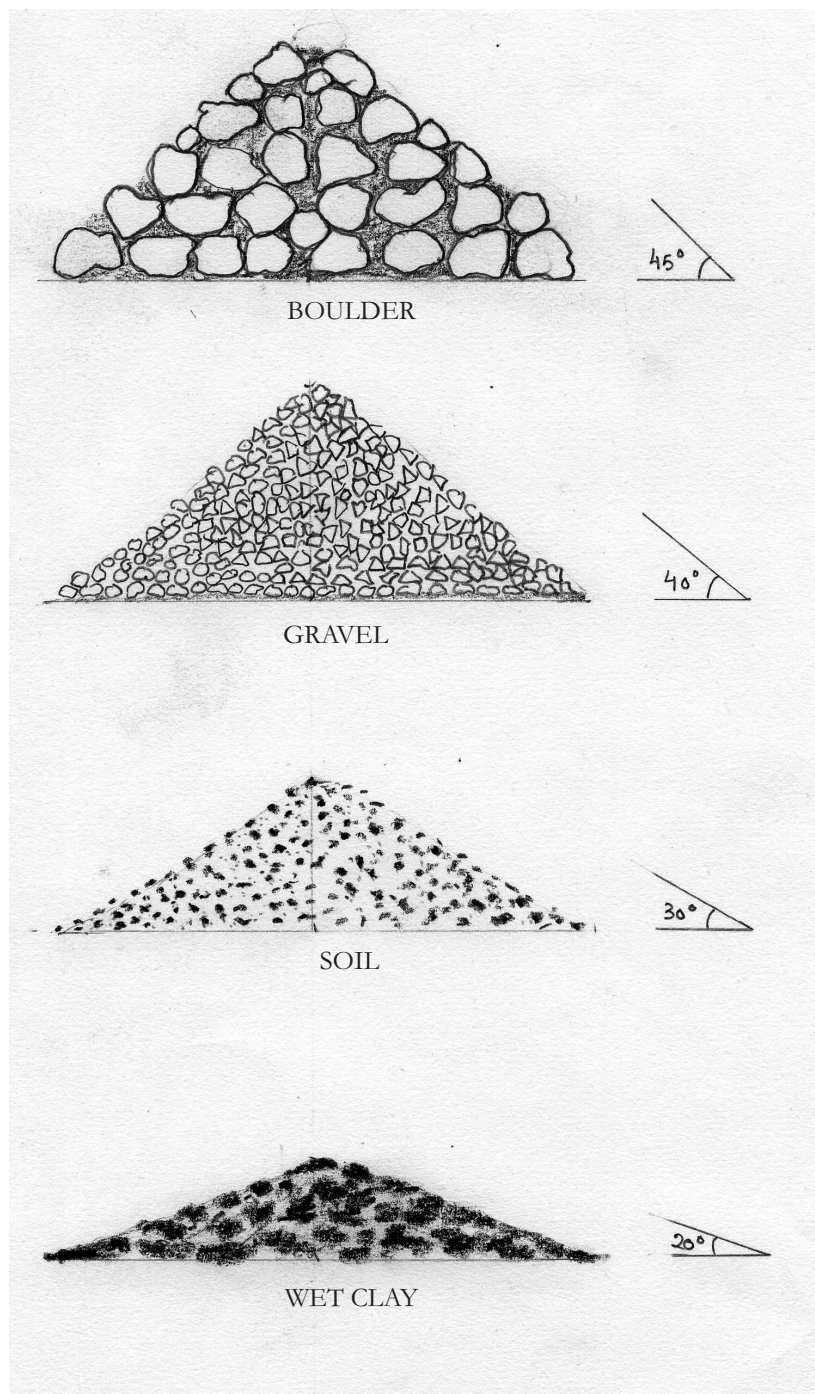

Figure 3.8: Natural angles of repose

When we observe a pile of sand, we can see that the width of the base is more than the height of the pile. When we try to scoop it up and pile it higher, it slides back into a more comfortable shape.

The angle of repose is a concept of great significance in low cost mud-boulder engineering. The earthen structure, which basically is a pile of compacted soil, has to be stable enough not to budge and topple over against the force of water. Therefore, while making dams, we must always try to approximate the natural way a pile of earth sits. In general, the slope of any watershed

structure must always be less than the natural angle of repose of the material used in its construction. The more squat the structure is, the safer it is. The natural angle of repose provides us with a quantitative basis for deciding how squat one needs to make a structure from considerations of safety. Table 3.5 summarizes the natural angle of repose observed for various materials.

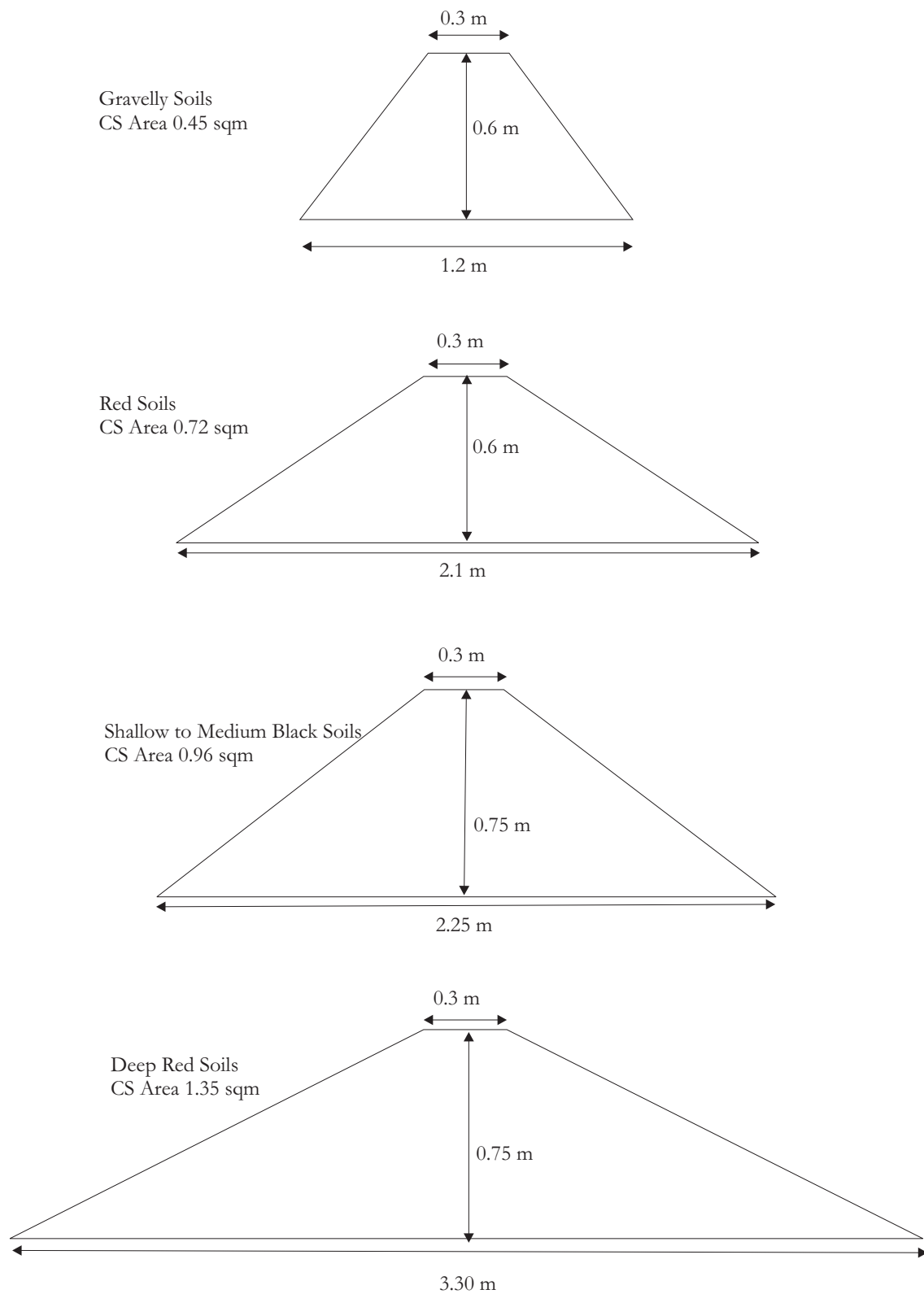

Figure 3.9: Cross sections of dams built from different types of soil. The lower the natural angle of repose of the soil used as construction material, the lower the slope of the dam and bigger its cross section

Table 3.5: Natural Angles of Repose for Different Materials

Material	Angle of Repose (Degrees)
Clay, wet	15-20
Clay, dry	25-30
Clay, damp, well drained	30-45
Sand, wet	15-30
Sand, dry	25-35
Sand, moist	30-45
Earth, dry	30-40
Earth, loose	30-45
Earth, moist	45-49
Earth, rammed	50-65
Sand and clay, wet	18-20
Gravel	40-45
Gravel, wet	27
Gravel and clay, wet	18
Gravel, sand and clay, wet	19
Gravel and sand	25-30
Shingle	38-40
Shingle and earth, moist	40
Vegetable soil, dry	30
Vegetable soil, moist	45-50
Vegetable soil, wet	15-17
Peat	14-45
Silt, wet	10-20
Silt, dry	20
Rubble stone	45

Source: Khanna, 1996

3.3.4 Possible Problems when Water fills Earthen Dams

Water harvesting structures have to be designed to withstand the different damaging actions of water that hits against them. This sections deals with the problems that water stored in the dam and rain can create.

a. **Seepage Line** - In any earthen dam, some water always seeps through the bund. The line along which the water seeps is called the seepage line. In relatively pervious and homogenous dams, the seepage line frequently crosses through the bund and appears on the downstream slope. Water percolates either through the bund or under its foundations. This water carries with it particles of soil thus forming tunnels/runs. Once formed these tunnels quickly enlarge, becoming cavities into which the bund sinks. This enables the water to “top” the bund and carry it away by erosion. The cause of this failure is a percolation velocity of water that is more than what the soil can safely sustain. Such a failure can be caused because of the lack of an effective stop wall

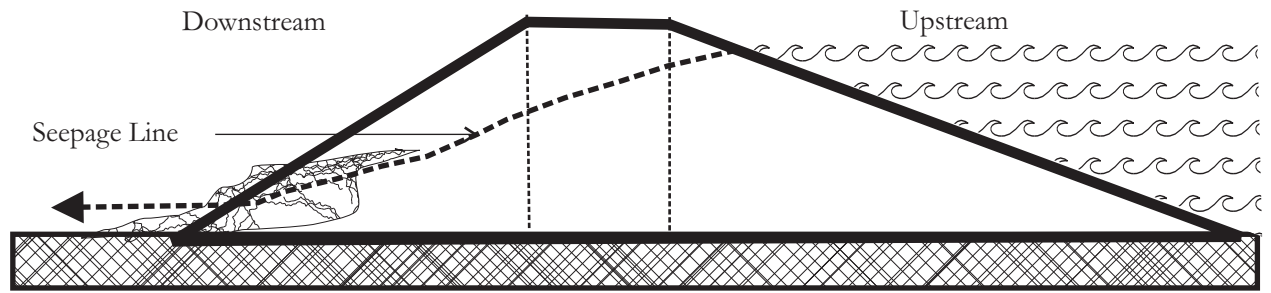

A. The seepage line going through the dam poses a risk to the safety of the dam

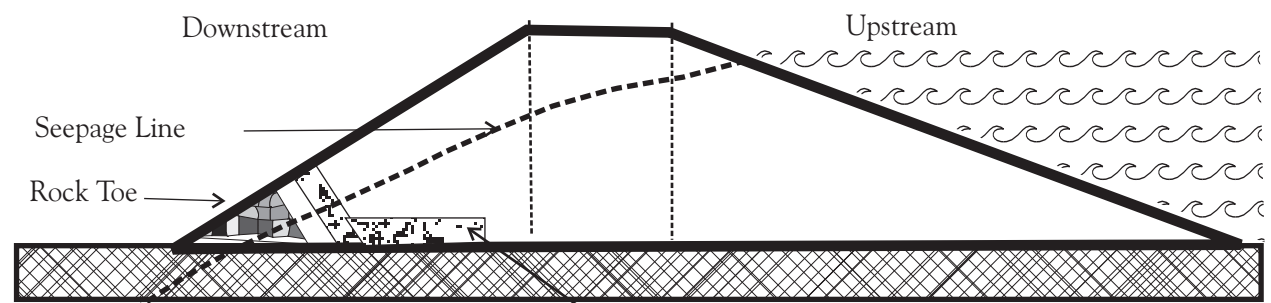

B. The rock toe and sand bed drag the seepage line down so that it does not go across the dam, thereby breaching it

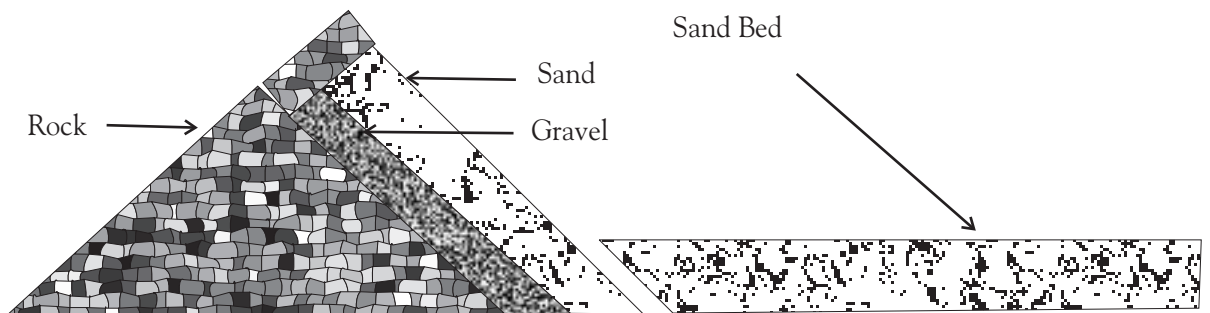

C. Close-up of Rock Toe and Sand Bed

Figure 3.10: Seepage line, rock toe and sand bed

to obstruct the path of percolation of water. It could also be caused by cracking of the soil, burrowing by animals (rats, bandicoots) and decaying roots of trees.

The seepage line is defined as the line marking the boundary between the saturated (wet earth) and unsaturated (damp or dry earth) zones inside an earthen bund. Studies have shown that the slope marked out by the seepage line is different in different materials. In a permeable soil, it is natural that the water will meet less resistance and will go across faster. In a clayey medium, water will move slower.

Even in a relatively impervious structure, some amount of water stored in a reservoir

percolates from the upstream side to the downstream through the body of the dam, thus forming a seepage line. If this line emerges above the base of the dam, it would slowly cut into the downstream wall of the dam and gradually erode it. This would pose a serious threat to the stability of the structure. In order to drag the seepage line downwards so that the water is drained within the base of the dam, a *toe drain* or *rock toe* is provided. (see Figure 3.10. This is explained in detail in the chapter on earthen dams)

Table 3.6
Slope of Seepage Line in Different Materials

Material	Slope of Seepage Line (%)
Clay	25-30
Good compacted soils	25
Clayey Loams	20
Fine Silt	17
Loam	13
Fine Sand	12
Coarse Sand	10

Source: Khanna, 1996

b. **Sloughing.** Sloughing of the side slopes of an earthen bund is said to take place when the water face of the bund is cut into and eaten away by the action of waves or receding water. As the water recedes it carries off some soil particles, leaving behind large pore spaces. On drying, these spaces collapse, leading to further erosion. This leads to the slope becoming so steep that slipping of the upper layers occurs and the top width of the dam is gradually eaten through, so that overtopping and failure ensue. To protect bunds against this action, pitching or rivetment is undertaken on the water face of the bund. Use of vegetative measures can also be effective.

c. **Scouring.** Rainwater falling on the bund acquires scouring velocity as it flows on the downstream face of the embankment. It, therefore, cuts channels on the downstream side and weakens the structure. Pitching and vegetative measures on the downstream side help keep the velocity of flow within the non-scouring limit.

d. **Overtopping.** All causes of earthen dam failure ultimately lead to overtopping. Water washing over the top of the bund gradually erodes the top and downstream slopes, thus cutting a channel through the bund to a depth below the Full Reservoir Level (FRL) which speedily results in a breach. To prevent this, the top of a bund is raised to a certain height called the 'freeboard' above the Full Reservoir Level (FRL).

3.3.5 Upstream and Downstream Slopes of Earthen Embankments

Dams and bunds are pyramid shaped walls blocking the flow of water. The side facing the oncoming water is called the upstream slope (because it is looking up the stream!). The other side facing away from the water is called the downstream slope (because it is looking down the stream!). The natural angle of repose of the materials used for the dam enable us to decide the precise slope that the upstream and downstream sides of the dam should have so that:

1. they withstand the weight of water standing against it
2. the layer of soil covering the dam is not eroded by the action of water

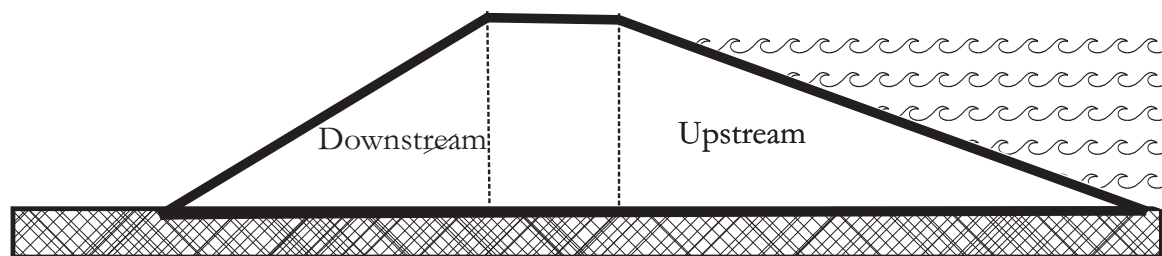

Figure 3.11: Upstream and downstream slopes in earthen structures

The downstream slope of the bund props up the upstream side from behind. The downstream slope of the bund is subject to erosion by the scouring action of intense rain running down it. The upstream slope of an earthen dam faces the full pressure of the impounded/stored water leaning against it. It is also subject to erosion by intense rainfall and the sloughing action of receding water. Saturated soil is less stable than dry soil. To take the load of stored water and to protect the bund from erosive action, the upstream side should have a gradual, flatter slope, which is lower than the slope of the downstream side (see Figure 3.11).

The relationship between the material used on the outer face and the slopes is shown in Table 3.7 below.

Table 3.7

Materials used on the Outer Face and Slopes of Structures

Material	Slope
Boulder	High
Murram	Medium
Coarse soil	Low
Clay	No!

3.4 Safety Measures When Building with Earth

3.4.1 Settlement Allowance

An earthen dam, even after compaction, will always sink a little bit. It will ‘settle’ due to its own weight and increased moisture caused by water storage, apart from the direct impact of rainfall. Therefore while designing an earthen dam we make an allowance for this tendency for soil to settle by increasing the height of the dam. This is called the **settlement allowance**. The settlement allowance depends on the type of fill material and the method and speed of construction. The design height of the dam will, therefore, be lower than the height immediately after construction. This means that the bund during the construction phase should be raised 10 to 25% in excess of the design height. An understanding of this is important because large settlement on bunds could lead to overtopping of the bund. It must also be remembered that the bund would settle the maximum in the portion where it is the heaviest, i.e., over the deepest portion of the stream, where its height is the maximum. Thus the bund must be convex shaped or raised in the middle (see Figure 3.12).

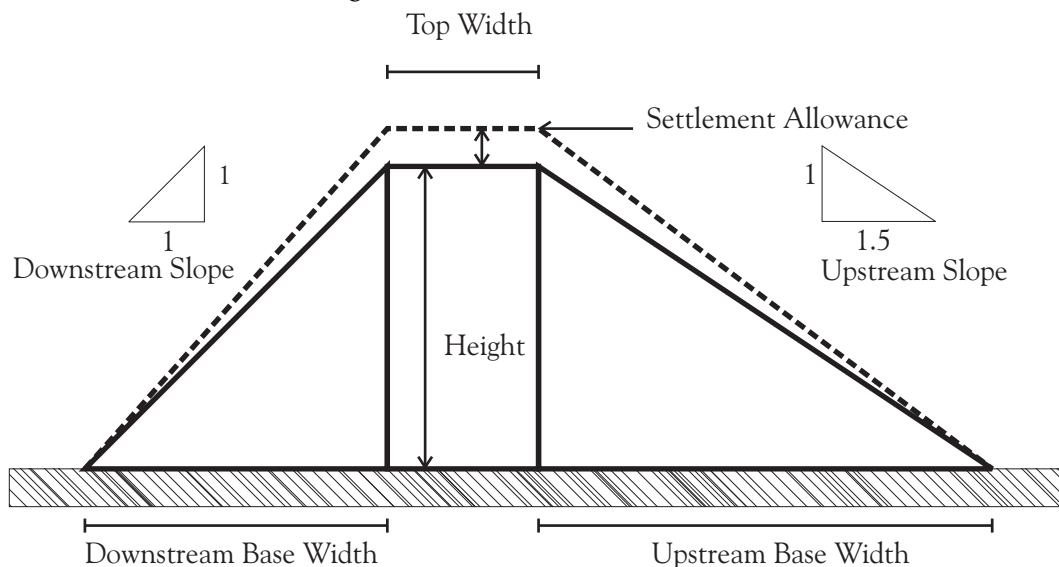

Figure 3.12: Settlement Allowance in Earthen Dams

3.4.2 Top Bund Level (TBL)

The TBL refers to the maximum height of the dam. If water flows over the top of the bund in an earthen dam, the dam will break. Hence, unlike in masonry or boulder structures, the excess water cannot be directed over the top of an earthen structure. Therefore, the TBL in all earthen structures has to be kept higher than the FRL.

3.4.3 Full Reservoir Level (FRL)

A dam blocking the path of flowing water creates a large bowl for a pool of water to be stored. This bowl, actually a valley, is called the reservoir. The full reservoir level is the maximum height till where we want the water to fill up in the reservoir. It is always set below the top height of the dam so that water does not go over the top. Exactly how the FRL is arrived at is explained in detail in the earthen dams chapter

3.4.4 Maximum Flood Level (MFL)

The MFL is the maximum level up to which water rises in a structure after an intense spell of rainfall. This provision is given to take care of extraordinarily high floods which might damage the structure if the floodwaters are not routed properly. It also takes care of the temporary obstructions in the exit weir during floods due to accumulation of fallen tree trunks, leaves etc.

3.4.5 Freeboard

The difference between the TBL and the MWL is called the 'freeboard'. In other words, freeboard is the difference in elevation between the top of the bund and the maximum level upto which floodwater rises in a dam. Normally, the freeboard should be at least double the difference between FRL and MWL.

3.4.6 Surplus Weir

Water in excess of the FRL is drained out by a surplus weir. Spells of rain can vary greatly in intensity. There may be a sudden storm and dangerous amounts of water may have to be dealt with. A safety valve is required that allows some of the runoff to go. This is especially important in earthen structures where the absence of such a safety valve would lead to water flowing over the top of the structure. This would definitely break the dam.

Therefore, we want to give water a way out through an outlet as soon as our structure has filled up. To drain this excess out, the size of the exit has to be able to deal with the maximum possible rain that can fall every second. We know that this volume of rain is called the peak runoff. The size of the exit or surplus weir has to be big enough for this peak runoff volume to pass through. In other words the maximum possible rain should get in and get out of the dam at the same time and with the same speed, simultaneously, so that the water level in the dam does not rise above the FRL. The exact design of the surplus weir is explained in the earthen dams chapter.

Table 3.8
Differences Between Earthen and Boulder Structures

	Boulder	Earthen
Surplus Weir	At the top of the Structure	Side of the Structure
Side Slopes	U/S > D/S	U/S < D/S
Maximum Height	At the Sides	In the Middle
Primary Objective	Erosion Control	Water harvesting

3.5 Topography: Knowing the Lay of the Land

The landscape of a watershed determines where we can stop water and how. To read or be familiar with the undulating surface of the land, we have to know certain concepts. Contours, slopes, levels, benchmarks are the language used to understand landscape when we want to weave our watershed interventions into the delicate fabric nature.

3.5.1 Contour Line

Any point on a flat surface like a table top, will be at the same height from the floor as any other point on the table top. A line drawn through these points can be said to be a contour line. **A contour is an imaginary line that joins points of the same height.** It is a line so flat and level, even water could rest on it. Just like some water spilt on the flat surface of a table top would remain on it and not dribble down.

When we try to mark points at the same height on actual landscape, like on the side of a hill, these lines follow the curves of the land and look wavy. But they are not. They are at the same level so much so that if one dug a channel along the contour line, a ball would stop on it and not roll off. Contour lines are important because we need water conservation structures that do not allow water to flow off. They are particularly important when one wants to translate the uneven terrain of a watershed onto a map (see Figures 3.13 and 3.14).

3.5.2 Vertical Intervals, Horizontal Intervals and Slope

The distance between two points in the watershed can be expressed in two ways:

1. the horizontal interval (HI) and;
2. the vertical interval (VI)

The horizontal interval is the distance straight across as the crow flies, so to speak. For instance, from one tree to another, from the top of one hill to another, from the road to

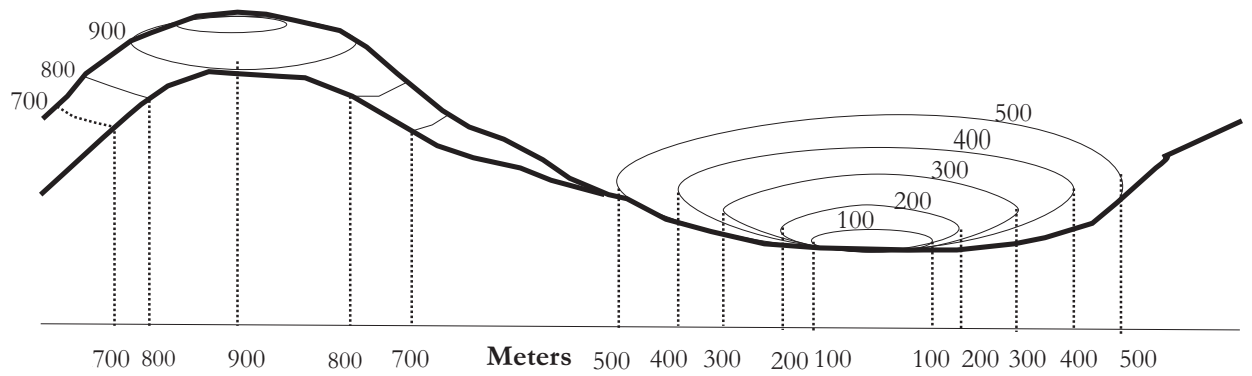

Figure 3.13: A section of hill and valley showing contour lines at different elevations

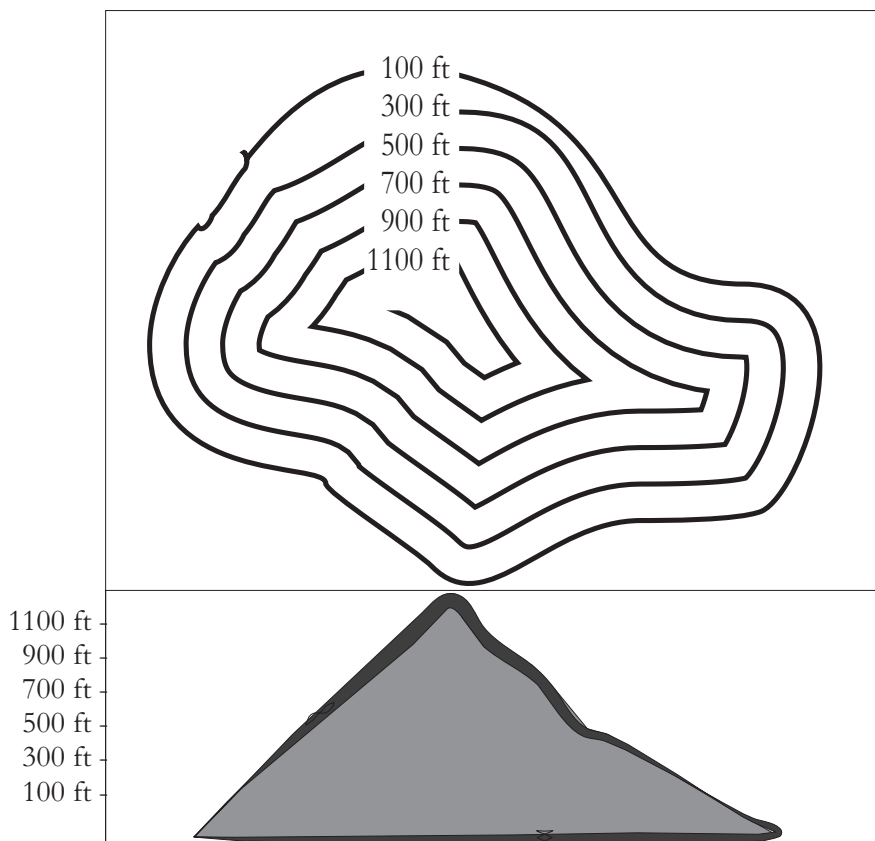

Figure 3.14: Contour lines of a hill seen from above

the house and so on. **The vertical distance** is straight up. For instance, from the bottom of a well to the top or from the floor to the roof, and so on.

But when we look at a hill it is not so simple. There is a slanting distance from the bottom of the hill to the top. This is called a **slope**. As we walk up a hill a few steps at a time we are gaining height. The point where we started from appears further and further below. For every few steps forward that we take we also take a few steps up. So we are traveling both horizontally and vertically at the same time. Just like stairs. The

railing or banister that joins the first step to the last one is the slope.

The slope of the land is the ratio of the vertical interval to the horizontal interval and can be expressed as such. Slope is also measured as a percentage or in degrees.

If we have walked a distance of 3 meters horizontally while gaining a height of 1 meter then we can say it in 3 ways -

1. The slope that I climbed was in a ratio of 1:3
- 2.

$$\text{Slope} = \frac{\text{Vertical Interval}}{\text{Horizontal Interval}} \times 100 = \frac{1}{3} \times 100 = 33\%$$

or I have climbed a slope of 33%

3. In the language of Trigonometry,

$$\text{Slope} = \tan\theta = \frac{\text{perpendicular}}{\text{base}} = \frac{\text{Vertical Interval}}{\text{Horizontal Interval}} = \frac{1}{3} = 0.33$$

Now from the tables given in any standard book on Trigonometry, we can find the value of the angle θ whose $\tan \theta$ is 0.33.

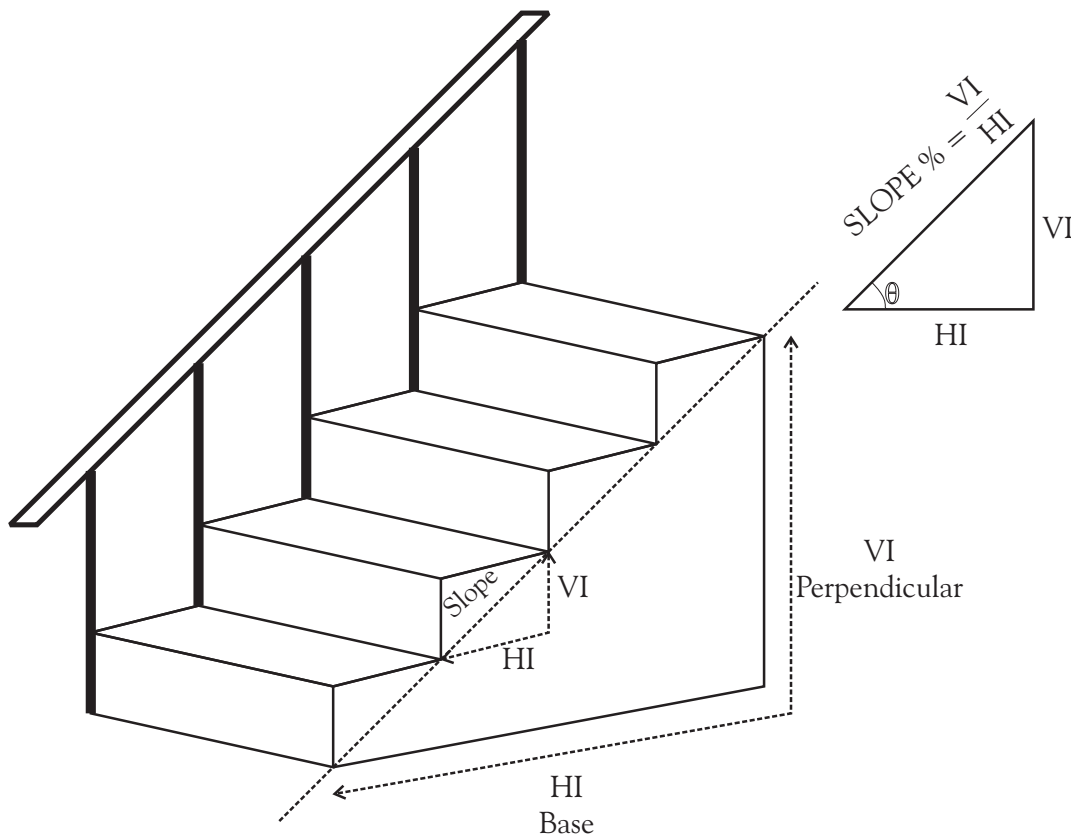

VERTICAL INTERVAL, HORIZONTAL INTERVAL AND SLOPE

Figure 3.15: Understanding Vertical Interval, Horizontal Interval and Slope

3.5.3 Mean Sea Level, Reduced Level (RL) and Benchmark

To measure the elevation or height of any place – up on a hill, down in a field, standing on a river embankment – we need a reference point or a **benchmark**, the point from where we begin measuring.

All over the world the commonly agreed upon point from which (with reference to which) we measure heights is the **Mean Sea Level (MSL)** because water keeps the same level everywhere. This is the average surface level of the sea and is taken to be zero. The elevation, i.e., the height or depth of any point is measured on this earth in feet or meters from the Mean Sea Level (see Figure 3.16 for an illustration of the concept). The elevation of a point from the Mean Sea Level is called its **Reduced Level (RL)** (reduced or expressed with reference to the Mean Sea Level). This indicates that the height of a place is in relation to the Mean Sea Level.

However, for convenience in a watershed programme, we generally agree upon a **benchmark** that is closer to our area. The RL of this point (its height in relation to the MSL) is publicly known and the point is in itself some kind of landmark in the area. We take the RL of this point as 100 and then mark heights of points in the watershed with respect to this benchmark.

3.5.4 Drawing Dams

Before making a dam, we need to completely visualise its design. This requires viewing the dam from different perspectives.

1. When we view the dam as if we were flying up in the sky on top of the dam, we will be seeing the plan or layout of the dam. We can see that the plan involves drawing the length and width of the dam;
2. Suppose we cut the dam vertically across its width, we get the cross-section view of the dam. The cross-section entails drawing the height and width of the dam;
3. And if we cut the dam vertically across its length we get the longitudinal or L-section view of the dam. This requires drawing the height and length of the dam.

These form the three basic types of engineering drawings that are usually made of watershed structures. In exactly the same way we can also take 3 views of any drainage line on which we plan to build these dams.

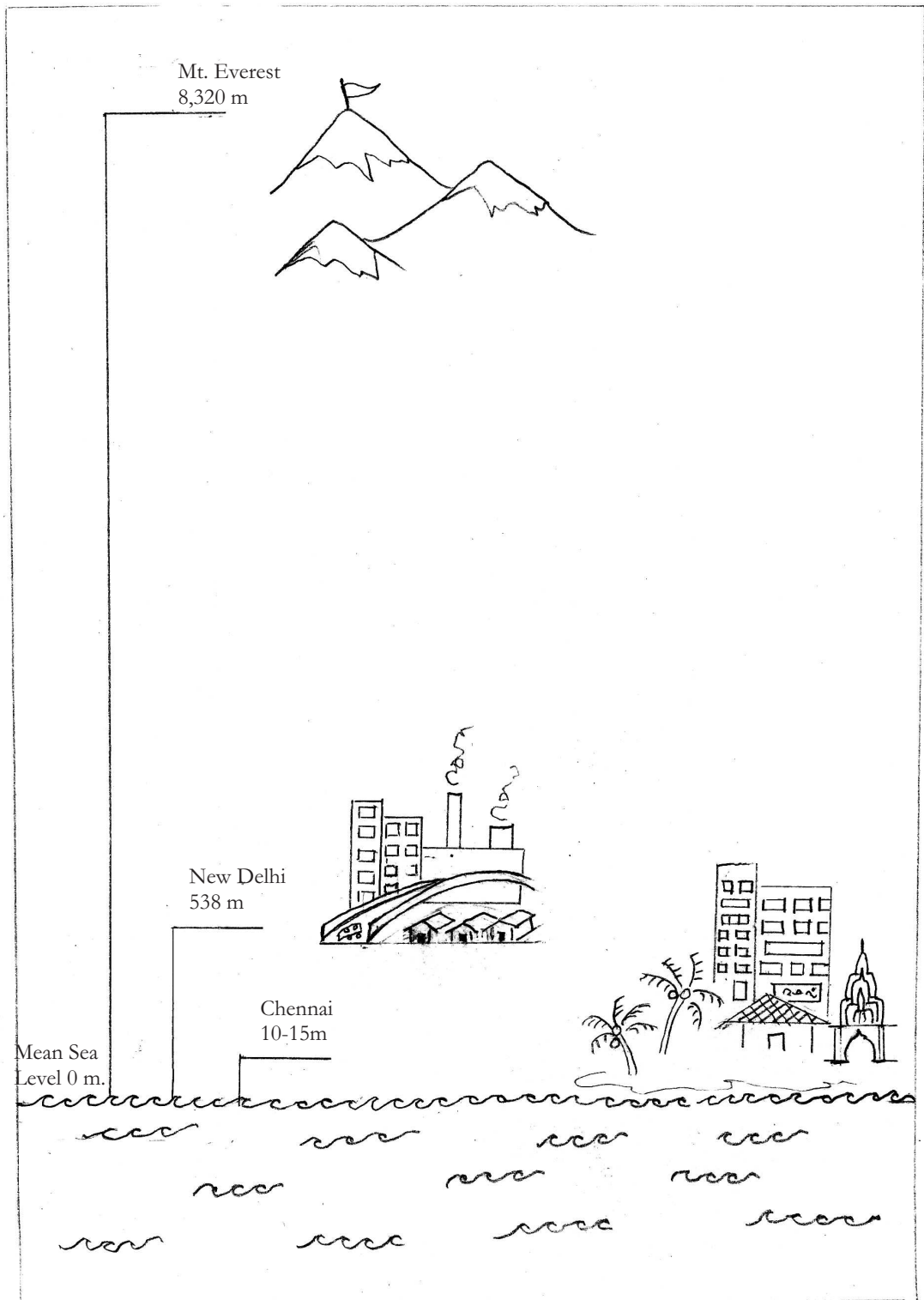

Figure 3.16: All over the world the commonly agreed upon point with reference to which we measure heights is the Mean Sea Level (MSL)

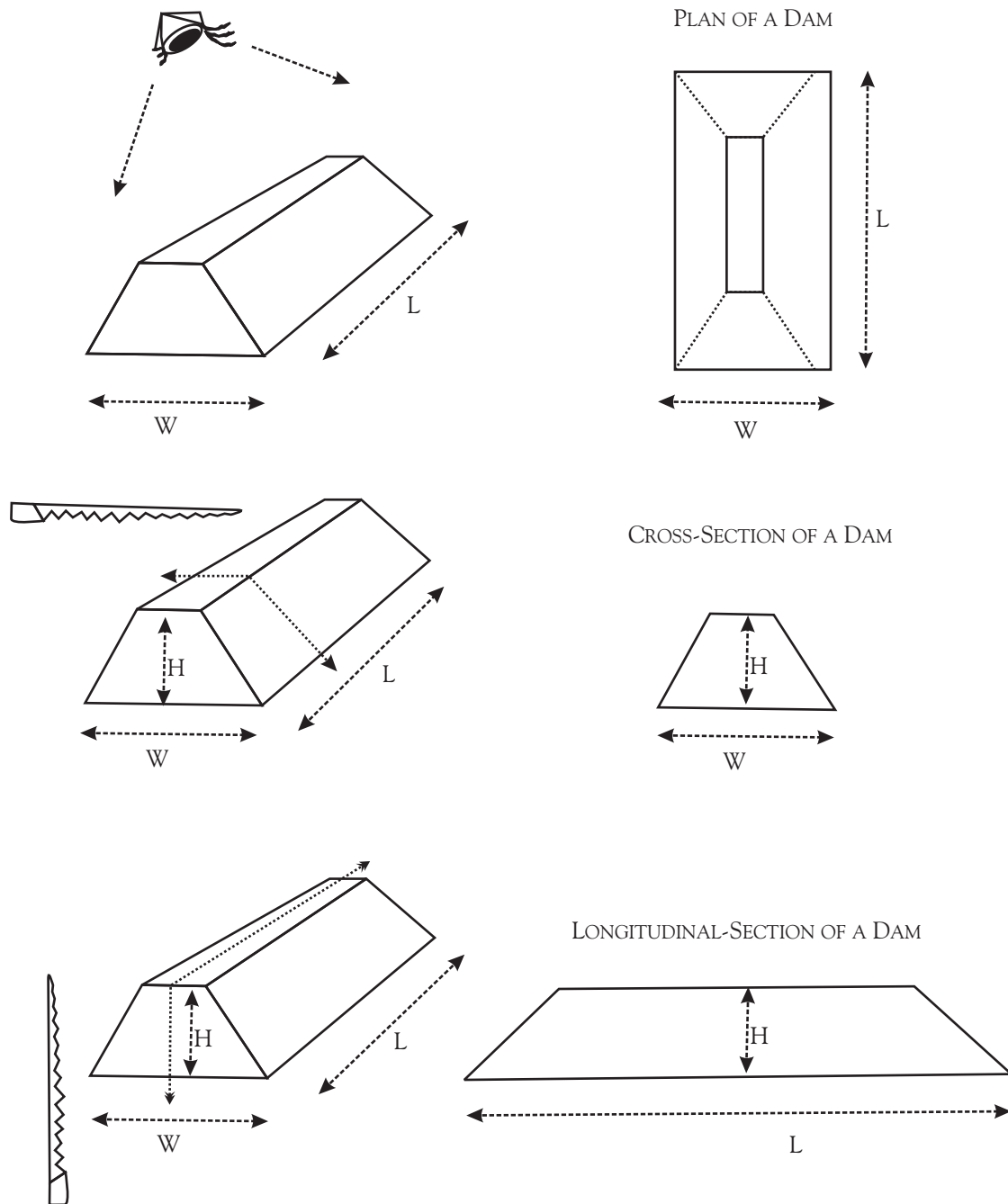

Figure 3.17: Cross Section, Longitudinal Section and Plan

3.6 Watershed Interventions

Watershed interventions are made at different points in the village in a location-specific manner utilizing locally available materials and the vast knowledge of the local people regarding water flows and resource availability. Interventions are broadly organized according to the *ridge-to-valley* principle. A typical mistake is to

begin by constructing a water harvesting structure in the lowest part of the watershed without treating the upper part of the catchment. The result is a rapid silting up of the storage capacity created because of the soil erosion taking place in the upper part of the catchment. Thus, we must begin with the treatment of the ridge area followed by the smallest drain, moving on to larger and larger drains in the watershed, arresting the runoff at each point. Some of the ways to catch water in different parts of the watershed are listed below.

3.6.1 Interventions in the Ridge Area

1. On slopes greater than 25%,
 - * protection and plantation of grasses, shrubs and trees native to the area
 - * where boulders are available, **contour bunding with boulders** (without disturbing boulders embedded in the ground)
2. On slopes between 10-25%, **contour trenching**
3. On slopes less than 10%, **earthen contour bunding**
4. **Plantation of trees** on barren patches of forest area where the crown cover is less than 40%
5. Encouraging **natural regeneration** by grazing control, stump dressing of freely coppicing varieties, micro-water harvesting structures and weeding around saplings, treating bamboo clumps by shoring them up with mud etc

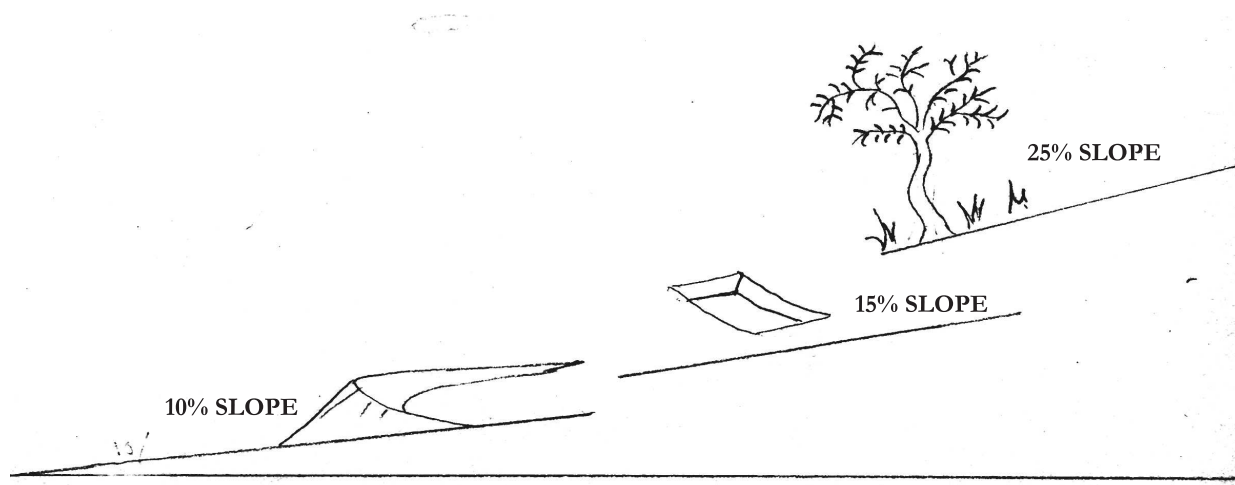

Figure 3.18: Measures for Ridge Area Treatment vary with slope

3.6.2 Interventions in the Drainage Line

1. Where the local bed slopes are above 20% and where thinning operation yields adequate raw material, **brushwood checks**
2. Where local bed slopes are between 5-20%
 - * if boulders are freely available, **loose boulder checks**
 - * if boulders are not easily available, **boulder-cum-earth checks**
3. Where local bed slopes are less than 5%
 - * **Earthen dams**, which serve as percolation reservoirs in the upper catchment.
 - * **Sand-filled bag structures** in order to check the velocity of stream flow where sand is locally available
 - * **Gabion structures** where velocity and volume of peak run-off is too high for loose boulder structures
4. Where the stream embankments have been severely eroded:
 - * **naala training**, including deepening channels and raising embankments, along sections of streams, where during peak floods, the stream flows over its embankments and damages the fields alongside
 - * **embankment stabilisation through gabions or sand-filled bag structures** in stretches where the banks are particularly vulnerable and need reinforcement
5. Where groundwater harvesting wells are located alongside:
 - * **Underground dykes** in the discharge zone where the impermeable strata are overlain by thin layer of permeable deposits

3.6.3 On-Farm Interventions

1. **System of bunds and diversion channels** for a stretch of fields from local ridge to drain. While in permeable soils the bunds help increase soil-moisture profile, in waterlogged soils they act as drains to transport excess moisture out of the fields
2. **Seepage drains** on waterlogged fields which help vertical drainage of excess soil moisture into permeable strata underlying the top soil, simultaneously increasing groundwater recharge
3. **Location-specific Grassland development** for ensuring adequate fodder supply
4. Plantation of **horticultural species around wells and along bunds**

3.6.4 Water Harvesting Structures

1. Deepening and repair of traditional water harvesting structures
2. Earthen dams
3. Dugout farm ponds

3.6.5 Special Precautions while Locating Structures

3.6.5.1 Ridge Area

While doing ridge area treatment, one must remember that we are trying to reduce soil erosion and not to increase it. Or, to put it in another way, the aim of watershed development is to reduce the slope of land, not to increase it.

- ✗ Special care should be taken not to disturb the existing vegetation.
- ✗ If boulders are to be used in any structure, they should never be dug out from the soil.
- ✓ Slope > 25% vegetative measures, boulder contour bunds
- ✓ Slope 10-25% contour trenching
- ✓ Slope < 10% earth contour bunds

3.6.5.2 Drainage Line

There are some general considerations which should be borne in mind while selecting the site for locating structures on the **drainage line**:

- ✓ The width of the drainage line at that point should be narrow
- ✓ The width of the drainage line upstream of the point should be greater
- ✓ The embankments at that point should be well defined, stable and high
- ✓ The upstream bed slope of the drainage line should be low
- ✓ The upstream bed of the drainage line should be made up of impervious material if the principal aim is to harvest water for irrigation. On the other hand, if the main aim is to increase the rate of groundwater recharge, this material should be relatively pervious.
- ✓ In structures where surplus weirs have to be constructed, ideally the sub-strata of the naala banks should be hard enough so that the banks of the weir do not easily get eroded.

Some of the most important of these structures are explained in detail in subsequent chapters.

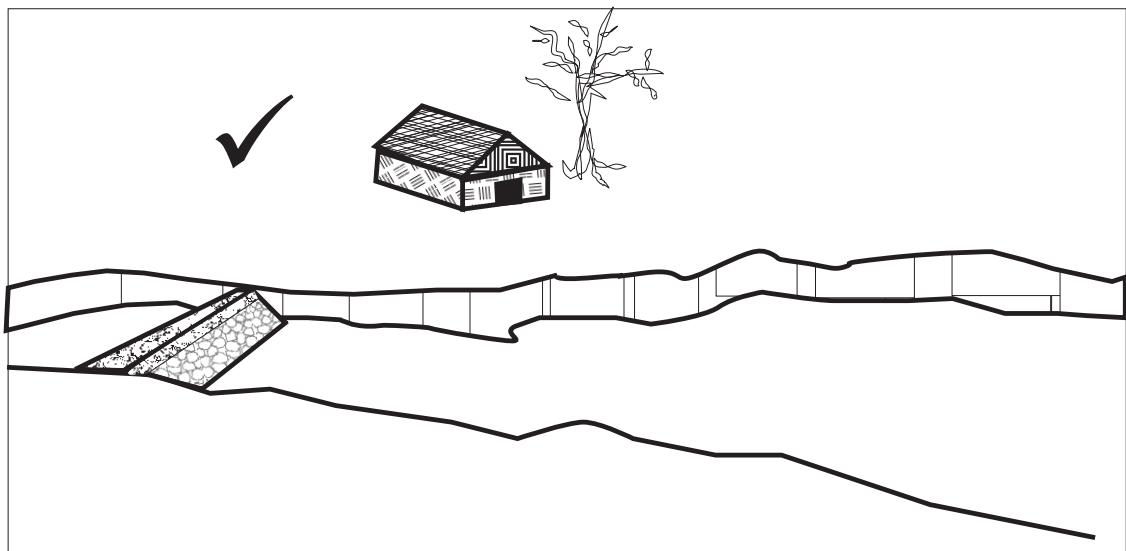
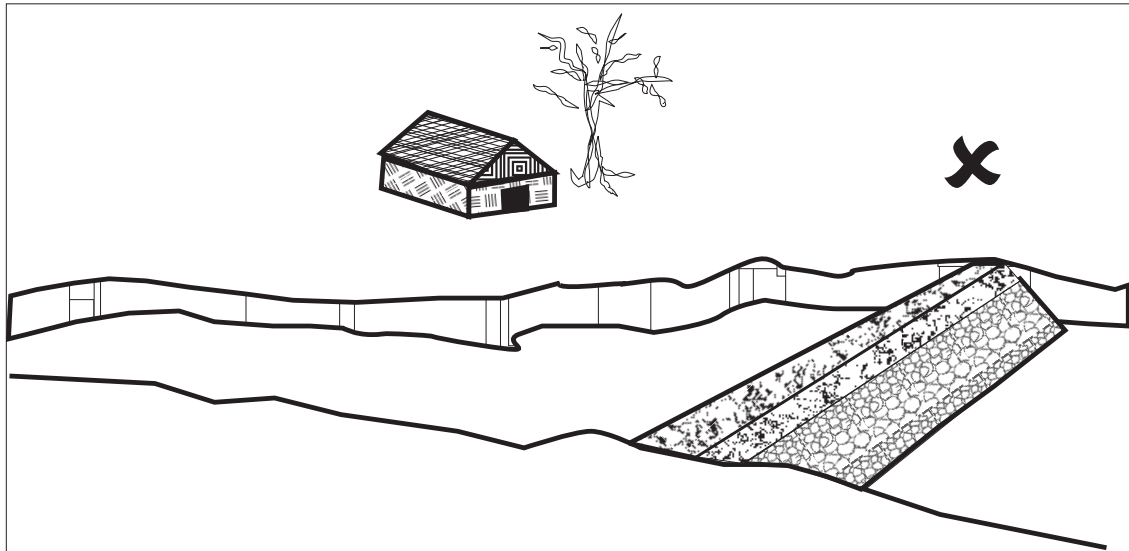

Figure 3.19: The width of the drainage line at the point where the structure will be located should be narrow

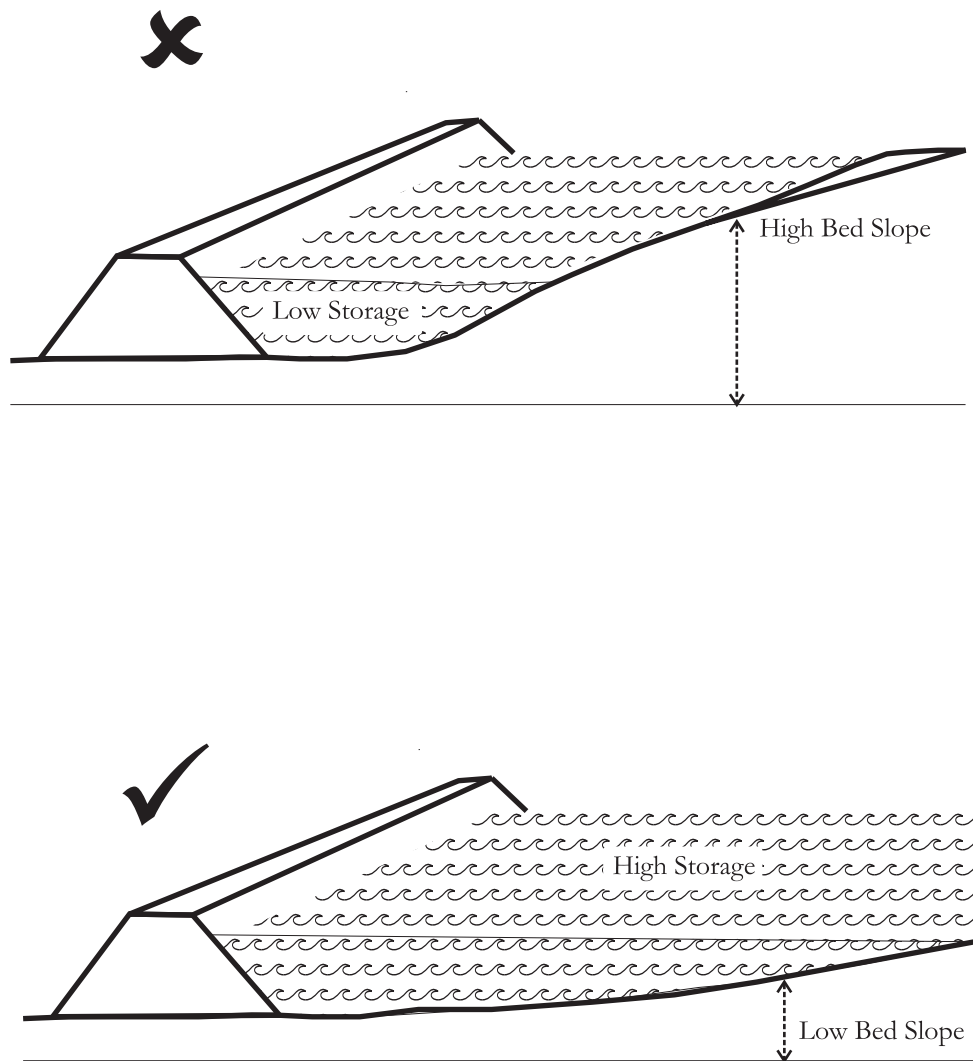

Figure 3.20: The upstream bed slope of the drainage line at the point where the structure will be located should be low

References

1. Bali, Y.P. (1979): 'Watershed Management—Concept and Strategy', in P.N. Bhatt (ed.), *Watershed Management, Lectures Delivered at Short Course*, Dehradun: Central Soil and Water Conservation Research and Training Institute.
2. Dhruvanarayana, V.V. (1993): *Soil and Water Conservation Research in India*, New Delhi: Indian Council of Agricultural Research.
3. Khanna, P.N. (1996): *Indian Practical Civil Engineers' Handbook*, New Delhi: Engineers' Publishers
4. Schwab, G.O. et.al. (1981): *Soil and Water Conservation Engineering*, New York: John Wiley and Sons
5. Subramanya, K. (1994): *Engineering Hydrology*, Tata-McGraw Hill Publishing Company, New Delhi
6. Tideman, E.M. (1996): *Watershed Management: Guidelines for Indian Conditions*, Omega Scientific Publishers, New Delhi

4 | An Introduction to Social and Institutional Issues in Watershed Development

Watershed Development is not merely about harvesting rainwater. It is perhaps much more about sharing water equitably and in a sustainable manner. In this chapter we explain some of the steps that need to be taken in order to ensure that this really happens on the ground. While implementing NREGA projects these considerations will need to be borne in mind.

4.1 Participatory Planning

After the Hanumantha Rao Committee report of 1994, the Guidelines formulated for watershed development greatly emphasised participatory processes. However, a variety of studies show that participation, transparency and equity are some of the weakest aspects of the programme. Participatory Rural Appraisal (PRA) that was advocated as the tool for ensuring participation has perhaps turned into its own nemesis.¹ The spirit of PRA was demystification of the knowledge of experts and valorization of the knowledge of the people. The idea was that the programme would turn into a people's programme in which others (such as officials, NGOs and experts) will participate. Sadly, PRA has been turned into a "mechanical" tool wherein various prescribed exercises are ritually carried out without changing the overall tenor of the programme, as externally devised and implemented (Kolavalli and Kerr, 2002). Lip-service is routinely paid to the idea of participation without a genuine, organic practice of it. Moreover, it has also been recognised that PRA may be all right as a short-cut to getting quick, broad information. But in a programme as large as a watershed project, there is need for "hard" data for which a much more comprehensive base-line survey would be required. (AFARM, 1998; Samaj Pragati Sahayog, 2005a).

Perhaps a much more powerful tool is provided by PRM (Participatory Resource Mapping). The cadastral (*patwari*) map is used for data collection, resource literacy, planning and community mobilisation. This methodology was first developed by Centre for Earth Science Studies, Thiruvananthapuram in collaboration with the Kerala Shastra Sahitya Parishad (KSSP) (Sinha and Varma, 1994). More recently it was used

¹ See Mosse (2005) and Samaj Pragati Sahayog (1999) for a scathing critique of the practice of PRA in watershed projects.

very powerfully during the People's Planning Campaign (PPC) in Kerala.

It is not difficult to understand why the resource-poor do not find a strong voice in decision-making in development programmes in an unequal society like rural India. It is no surprise, therefore, that this has generally not happened in watershed projects. So it may be unduly unfair to criticize watershed projects on this count. However, it is certainly possible and worthwhile to suggest specific steps that need to be taken that constitute a substantive attempt in this direction. Even after these steps, we may not achieve perfectly participatory processes or equitable outcomes, but the programme must still be judged by the extent and nature of effort it made in this direction.

Bina Aggarwal (2001) provides a very useful typology of modes of participation.

Table 4.1
Typology of Modes of Participation

Mode of Participation	Characteristics
Nominal	Membership of groups
Passive	Silent participation in meetings or getting information of decisions after meetings
Consultative	Being asked for opinions without necessarily being able to influence decisions
Activity-specific	Volunteering to undertake specific tasks
Active	Pro-actively expressing views, taking other initiatives
Interactive (empowering)	With voice and influence on decisions
Informed (empowered)	Being able to take into account information and opinions of external agents ("experts") and make considered decisions

Note: Adapted from Aggarwal (2001)

To her table we have added a row – informed participation, which we see as the ideal that must be moved towards. Here participation is seen as a two-way process of intense dialogue between the local people and the outside agency, be it government, NGO or professionals. We see the watershed action plan as emerging out of this "hermeneutic" exchange of ideas (Gadamer, 1990). Neither a romanticisation of people's knowledge nor a debunking of the expert. Rather a process of demystification of expertise in the process of valorising popular understanding, through a creative dialogue between the two. Such a dialogue has been rare. Most programmes have been either top-down impositions or a strangely hands-off acquiescence in whatever mistakes that may be taking place on the ground that "this is a people's programme, people know best, so what can we say" (Mihir Shah, 1998). The challenge is to give enough time and space for differing viewpoints to be expressed, understood and acted upon so that a process of truly informed participation can be set into motion. The people must guide the plans (not necessarily determine them, because there are cases where the so-called "people" are

the elite or simply misguided and plain wrong about certain ideas).

Deciding the activities to be included in the action plan and their sites must involve participatory methods such as transect of the entire watershed by groups of villagers, utilizing their deep knowledge of local conditions. This includes their understanding of the topography at a micro level, as also water flows and soil types. As also the socio-economic profiles of the families likely to benefit or be adversely affected by each proposed intervention. We get a picture of groups of villagers moving together, along with various professionals, across the watershed debating the merits and demerits of different proposals. Only when the plan is arrived at through such a deeply consultative process can it be called genuinely participatory and only then will it stand the test of time and village debate.

4.2 Focus on Equity

One must not make the mistake of romanticising the notion of the village community. Indian rural society today (adivasi pockets no exception) is deeply fractured across social and economic lines. Discrimination against women, dalits, adivasis and the poor in resource-use and access is widespread. Any development programme based on local initiative needs to be necessarily accompanied by effective social mobilisation in favour of these socially and economically disadvantaged groups. Detailed written agreements on sharing of water and other benefits need to be worked out well before any construction activity is started. The interests of the landless have to be specially borne in mind. Otherwise all the water you harvest will be cornered by the dominant elite. And this is what has happened in most watershed programmes in India. It must be recognised that the benefits of public investment on public land must be seen as a public good, to be shared with equity amongst all sections. For example, the fishing rights to a public pond may be reserved for the landless or dalits. The usufructs from protected/regenerated forests must extend to the dalits/landless/adivasis. Even the benefits from investments on private land should be shared as far as possible. For instance, if investments on private land exceed a certain threshold, there must be provision that its benefits will be shared by groups of farmers. They can, for example, share water from a well or pond constructed under the project. The bottom-line has to be that benefits from any resource created through the project must be equitably shared. The principles of equity must extend to the following aspects, among others:

Conflict Resolution: The entire range of activities to be included in the action plan must be discussed threadbare in a series of village meetings. There is bound to be some contention and conflict, but the attempt must be to allow this to be expressed and resolved in a democratic manner in the Gram Sabha. For example, detailed

compensation packages need to be worked out for those who may lose a little of their land/assets due to dams to be constructed. Without a satisfactory resolution of all such conflicts, work cannot proceed

Beneficiary selection: This must be done in village meetings where detailed criteria are enlisted, reflecting considerations of equity. A hierarchy of preference must be created where the landless, poorest farmers, dalits, adivasis and women-headed households get highest ranking.

Benefit sharing: This involves complex questions of hours of pumping, sequence of irrigation, cropping patterns, share of cattle, ensuring share of landless etc. Before any structure is built, detailed agreements have to be thrashed out on all of these aspects. The outstanding example of water sharing, of course, is the late Vilasrao Salunke's Pani Panchayat in Maharashtra. Water is made available to each family at half an acre of irrigation per person, with a maximum of 2.5 acres per family

4.3 The Question of Gender

Perhaps the most "universal" equity issue, cutting across classes and communities, is the discrimination suffered by women. The challenge of women's empowerment has to be a thrust area in national reconstruction. We need to develop local institutions led by a cadre of local women who would become the transmitters of new development perspectives in their respective areas. Only with the growth of such local leadership can various development programmes initiated by the government be truly mainstreamed in these areas. Or else the massive public investment being made over the years will continue to largely go down the drain.

Women suffer discrimination in all spheres of life. The prejudice against the girl child has resulted in an unfavourable sex ratio in India. To every 1000 men there are only 933 women. The national literacy rate for women is only 54%, compared to 76% for men. There is a clear bias against sending girls to school. Among Dalits and Adivasis, the female literacy rate is as low as 8%. 40% of girls aged 10-12 years never enroll in school (as against 19% boys). Between 100,000 to 125,000 Indian women die from pregnancy related causes every year. This is 25% of all maternal deaths every year in the world, most of which are preventable. In rural India, only 10% of deliveries take place in hospitals. 75% women suffer silently with reproductive tract infections

It is women who will need to take the lead if these inequities that women suffer *qua* women are to be redressed. This does not mean a conflict with men. Rather, it needs a systematic effort to so empower women that they provide the lead to the entire process of social transformation being attempted. For it has been the experience of development programmes all over the world that in the family it is the woman who is best able to

appreciate, understand and articulate the holistic view of development. Most men will more generally tend to narrowly focus on an objective such as gross income. Which in so many rural settings ends up, in male dominated decision-making families, being spent on things like liquor. Women, on the other hand, when they have to shoulder responsibility, worry about the health and education of their children. They pay careful attention to the uses to which the hard-earned income of the family is put. They are most active in credit Self-Help Groups. Women's empowerment has to be, therefore, the foundation of our strategy, both because it is women who are most disadvantaged, and because it is women who have shown that they can take the larger view of development that we are aiming at.

Over the last two decades, several attempts have been made to introduce gender sensitivity and gender orientation into development programmes. Sadly, however, much of this has remained restricted to mere lip-service and tokenism. The real challenge is to make stipulations and devise strategies to give a real chance for women's empowerment to occur. Nearly two decades of watershed development in India have shown that by simply putting the onus for change on a few women in committees and "users groups" here and there, has perhaps reinforced the ineffectiveness of women. The tight trap of patriarchy and consequently, women's reluctance to endanger their tenuous survival, call for guidelines that are firm, uncompromising and far reaching in commitment to gender equality.

For gender equality to happen an even handed approach will have to be dropped and women-specific interventions sharpened to overcome historical and social imbalances. Partial representation in village-level institutions inhibits even vocal women, resulting in tokenism and reinforcing the pointlessness that women feel. Watershed development is an ideal opportunity to address gender intensively and in a multi-dimensional way. Some outstanding examples of this work already exist in India.² Some lessons that emerge are:

1. A Separate **Women's Watershed Council**: This distinct women's body will enable women to articulate their perspective, perceptions and interests in a relatively uninhibited manner. This will facilitate the formation of a watershed action plan that genuinely reflects the needs and aspirations of women. The body will also act as an effective watch-dog to ensure that the implementation of the watershed programme necessarily takes women's interests into account. The WWC will nominate their leaders who will represent women in the Village Watershed Committee. It should be mandatory that WWCs are formed in each

² They are best summarised in a recent work by ANANDI (2003), a leading women's organisation in India.

village so that women are not only heard but play a decisive role in the formulation and execution of the watershed action plan. The WWC will provide the necessary back-up for the women members of the VWC so that their presence is not once again reduced to tokenism. The WWC would also play a big role in influencing the functioning of institutions such as the Gram Panchayat, ensuring greater and more effective participation of women in GPs and ensuring that they work in an accountable and gender-sensitive manner.

2. **50% reservation for women** in membership of the Village Watershed Committee
3. **Social Empowerment of Women:** For women to take on the massive planning and implementation exercises required for watershed development the basic obstacles that prevent their participation will have to be addressed systematically. These are the overburden of workload, health risks, child care, lack of information and socio-economic dependence. As entry point activities - drinking water, sanitation, alternative fuels, health facilities, crèches and improved shelter need to be provided for women to be free of drudgery and the struggle to survive.
4. **Technical and Legal Empowerment of Women:** Special efforts on arming women with information and technology on watershed development, natural resource management and procedures need to be introduced. This means making training accessible in relevant ways within the village. Again, most training efforts are designed and implemented in way that eliminates even the possibility of women participating in them. Low literacy levels and the inability to leave their household responsibilities for several days at a stretch prohibit women from investing in themselves. Therefore capacity building for women means, making it available at their doorstep, demystifying technology, learning-through-practice and interactive methods etc. Skill enhancement for women in relevant areas like masonry, alternative building technology will increase their options in finding employment both in the construction of the entry point activities as well as at watershed sites. An important aspect is legal information to women so that they know their rights within the law.
5. **Drudgery-reducing Appropriate Technology:** To reduce drudgery, the nature of construction work in watershed development demands the provision of drudgery-reducing manually operated equipment like wheel barrows, small cranes, rollers, bullock cart mounted tankers for water. This is particularly relevant for reducing the arduous nature of manual labour for women given their biological differences and responsibilities.
6. **Income Generation for Women:** Building on the assets created in watershed development and the increased availability of water, skill enhancement

opportunities for women must form part of the project. Improved agriculture, nursery management, livestock, fisheries, processing food and non-timber forest produce and other skills have to be imparted during the project implementation period to sustain the empowerment process afterwards.

7. **Management of Common Property:** The historical disinheritance of women from access to the primary means of production (land) make it an imperative that at least in common property (land, water, forests) management, women are given a primary role. The implementation of The Hindu Succession Act (Amendment) 2005, recognizing that women have equal rights over agricultural land, will have a powerful impact on gender equality. However, most married women in the village will be rightful owners of land in their maternal village. Common property must be therefore be used by women to strengthen their position in the village.
8. **Payment of Equal Wages for Men and Women:** Adherence to even as elementary a provision as this is not as common as it should have been. Indeed, the whole issue of payment of statutory minimum wages to both men and women through restructuring the schedule of rates needs separate treatment. This is done in Chapter 16

4.4 Voluntary Contributions

One of the distinguishing features of the watershed programme in India is that almost every project emphasises voluntary contributions by those who benefit from the work done. The idea is that such contributions will promote feeling of “ownership” of the programme among stakeholders. This will contribute to sustainable outcomes in the long-term. The voluntary contributions are saved in the Watershed Development Fund (WDF) that is to be used for repair, maintenance and use of assets created on common land. However, there are many instances of so-called *shramdaan* (voluntary labour) working more as a “shram-tax”, where landless labourers’ wages were being deducted at a fixed rate to meet a set target of voluntary contribution. Resulting in effect in the poor subsidising the rich. This is a very serious shortcoming that needs to be addressed. The best way is to work out differential rates of contribution by beneficiaries – different rates applying to different classes of farmers as also to different activities. Whenever the activity is on private land and contributes directly to income-generation, the contribution expected should be higher. Of course, in many tribal areas, since a number of those who work on watershed projects themselves own low-productivity land, *shramdaan* can occur on a reciprocal basis, reflecting their own traditional practices. We also find that land offered by farmers for constructing water-harvesting structures, for example, is not generally being taken into account as a contribution. This needs to

be taken into account as a voluntary contribution.

4.5 Ensuring Transparency and Accountability

This has already been discussed in some detail in the last chapter. The following points may be specially kept in mind:

1. Once the action plan is ready it must be presented for approval at the Gram Sabha meeting.
2. A summary of the approved plan must be put up for display in a public place and the complete plan must be available to anyone who seeks access.
3. All labour payments must be made in public.
4. Regular *jan sunwayis* (public hearings) must be held where detailed accounts are presented to the people, including all documents – sanction and release letter, pass books, cheque books, muster rolls, vouchers etc.
5. Boards should be put up in public places and at each major site, which display details of work done, costs, volume of water harvested, employment generated etc.
6. Wherever possible IT should be used to record, manage data and generate information on indicators to be monitored or measured

4.6 Sustainable End-uses of Harvested Water

4.6.1 Groundwater Regulation

Even while our entire focus is on harvesting surface water run-off and converting it into usable groundwater, watershed programmes do not adequately factor in the impact of unsustainable groundwater use. All the effort in harvesting rainwater may come to nothing if we do not regulate use of groundwater. Watersheds selected for treatment might vary greatly in the base-level of groundwater development. This is fundamental base-line data that must be collected at the start of a programme. We may be interested in recharging fallen water tables following over-exploitation of groundwater. Or else it may be a situation where groundwater use is under-developed. In which case we need to study the aquifer characteristics of different parts of the watershed and weave in a sustainable groundwater development and utilization plan into the overall watershed action plan. This is generally not done in most watershed projects implemented in India so far.

Not doing so has meant that even when there is a normal rainfall year, the watershed could face a drought. This is because farmers made an over-drawal of groundwater in the previous year. This is what is termed a “groundwater drought”. The water balance calculation must include what the community is doing with its groundwater.

The most important aspect of groundwater is that it is a common property resource, the means of access to which is privately owned. We generally access groundwater through private wells and tubewells. But drawal of water from our source can adversely affect the water in our neighbour’s water source. Depending on the hydrogeology of the watershed, the question “who is my neighbour?” gets answered. If the watershed is in an alluvial tract, for example, my deep draw of water can affect a farmer even hundreds of metres away. Thus, how farmers decide to collectively manage the groundwater resources of the village could have a deep bearing on how long groundwater survives. It could actually determine the entire efficacy of the watershed programme. Indeed, one could go as far as to say that sustainable and equitable management of groundwater could be the key area of rural governance in the 21st century.

In the present era of market fundamentalism, there are those who suggest that the best way to regulate groundwater and prevent its over-extraction is to develop groundwater markets. For them, the solution as always, lies in “getting prices right”. They forget that we are dealing with a common property resource with significant externalities – a classic market failure scenario. They fail to understand that as water becomes scarce, prices will tend to rise, gradually putting it beyond the means of the poorest farmers. And those users, such as large corporates, who can afford to pay and bid the highest, will enjoy a virtual monopoly over water, and could indulge in its unbridled exploitation.

The unique aspect of the situation is that water below my land is not “mine”. Groundwater is a non-stationary, “fugitive” resource that merges into water under another’s land in a fluid sort of way. By lowering the depth of his tubewell, my neighbour can squeeze all water out of my well. Without proper collective arrangements for groundwater use, there tends to be an infinite regress of competitive extraction, with farmers outbidding each other in depths of drilling. Competitive extraction of groundwater leads to disastrous outcomes, the worst of which are observable in coastal areas of Gujarat and Tamil Nadu, for example. Here, saline ingress of sea-water poses a virtually irreversible environmental hazard for farmers who have engaged in competitive pumping of groundwater.

What is required, therefore, is that we take a three-dimensional view of groundwater and see each aquifer as a common property resource. Wells and tubewells are to be viewed as the means used by farmers to extract water from this aquifer. Extraction of

water from this aquifer needs to be carefully, collectively regulated.

Considering the man-made crisis of water engendered in the country through deep drilling of tubewells, it may be useful to consider making it a condition of eligibility for a watershed project that

1. tubewells will be restricted only for drinking water
2. if at all tubewells are to be drilled for irrigation, they should only be if groups of farmers have a prior agreement on water-sharing and water-use with great care being given to sustainability of water extraction and use.³

4.6.2 Integrating Dryland Agriculture Packages with Water Harvesting

Unfortunately, watershed development in India has been one-sidedly preoccupied with supply augmentation. Little attention has been paid to the end-uses of harvested rainwater. In this respect it has failed to break with the dominant development paradigms of the 20th century, all of which are characterised by supply-side solutions. These solutions are caught in the infinite regress of forever trying to catch up with ever-expanding demand. They are a major reason for straining the delicate fabric of the eco-system, within which economic processes necessarily unfold.⁴

We need to recognise clearly that it is not merely enough to harvest rainwater. However much water we may conserve and collect, it will prove inadequate unless we take care to put it to sustainable uses. What is required is to find ways of not just increasing supply but much more critically reducing demand and regulating end-uses. So long as we do not question the emerging pattern of end-uses and pose the central question of efficiency of utilization of our resources, it will be absolutely impossible to endlessly augment supply. The fundamental binding constraint is really provided by the demand side. An integral element of the conservationist approach has, therefore, to be a quantitative and qualitative regulation of end-uses and demand.

³ The celebrated Hivre Bazar watershed project in Maharashtra has banned borewells for non-domestic purposes. In the IGWDP, Maharashtra, a watershed project is undertaken only if the community agrees to ban the drilling of borewells for irrigation purposes and the cultivation of water intensive crops such as sugarcane, bananas, grapes etc.

⁴ We need the perspective of Ecological Economics – the economy as a sub-system of the larger eco-system, comprising human beings as also natural resources and non-human species. Unlike the closed, isolated, self-contained circle of conventional economics, the economy is here an open system, engaged in a unidirectional flow of entropy—drawing low entropy from the environment and dumping high entropy waste into it. The economy is seen in co-evolution with the larger eco-system. Evolution implies a dynamic and adapting disequilibrium, without necessarily suggesting either endless progress or impending doom (see Mihir Shah *et al*, 1998, Chapter 2 for an extended discussion).

The first step in this direction has to be the integration into programmes of water conservation of a *sustainable dryland agriculture* strategy. Only then can we hope to avoid the tragic spectacle of Maharashtra's drought-prone Ahmednagar district of the pioneering Ralegaon Siddhi experiment, growing vast acres of sugarcane, making a mockery of the watershed approach, by engendering man-made scarcity of water. Unfortunately, watershed programmes in India's dryland areas have failed to break with the Green Revolution (GR) type agricultural package. The major flaw of this strategy was to try and indiscriminately apply the same package to all areas, quite irrespective of the agro-ecological specificities of each region, in a country with such immense diversity as India. The drylands of India have a delicate ecosystem, extremely vulnerable to external stress, be it that induced by the weather or the market. The GR package made farmers more vulnerable on both counts, by making them critically dependent on high quanta and precise timeliness of irrigation, as also by increasing their reliance on expensive market-procured inputs, such as hybrid seeds, chemical fertilisers and pesticides. The poorest were naturally the worst hit by a production plan that was unsustainable, both in economic and ecological terms. The unprecedented increase in suicides by farmers in recent times is the most dramatic and tragic expression of this vulnerability. It is necessary, therefore, to arrive at a package of agricultural practices finely tuned to the resource endowments of each watershed, which is both accessible to the poor (*low-cost*) and sustainable (*low-risk*).

References

1. ANANDI (2003): *Understanding Women's Experiences in Natural Resource Management*, Aga Khan Foundation, New Delhi
2. Aggarwal, Bina (2001): "Participatory Exclusions, Community Forestry and Gender: An Analysis for South Asia and a Conceptual Framework", *World Development*, Vol.29, No.10
3. Joy, K.J. and S. Paranjape (2004): *Watershed Development Review—Issues and Prospects*, CISED, Bangalore
4. Kelkar, G. and Dev Nathan (2004): *Strategic Gender Interventions And Poverty Reduction: Principles And Practice*, IFAD-UNIFEM Gender Mainstreaming Programme in Asia
5. Kulkarni, H. *et al* (2004): "Groundwater Demand Management at Local Scale in Rural Areas of India: A Strategy to ensure Water Well Sustainability based on Aquifer Diffusivity and Community Participation", *Hydrogeology Journal*, Springer-Verlag, Heidelberg, April
6. MoRD (2006): *From Hariyali to Neeranchal: Report of the Technical Committee on*

- Watershed Programmes in India*, Ministry of Rural Development, Government of India, New Delhi
7. Mosse, D. (2005): *Cultivating Development: An Ethnography of Aid Policy and Practice*, Vistaar Publications, New Delhi
 8. Shah, Mihir (2002): "Rethinking Watershed Strategy", *The Hindu*, January 29
 9. Shah, Mihir and P.S. Vijay Shankar (2003): "Watershed Reforms in India", Paper presented at the National Seminar on *New Developmental Paradigms and Challenges for Western and Central Regional States in India*, March 4-6, 2003, at Gujarat Institute of Development Research, Ahmedabad
 10. Shah, Mihir *et al* (1998): *India's Drylands: Tribal Societies and Development through Environmental Regeneration*, Oxford University Press, New Delhi
 11. Subroto Sinha and Ajaykumar Varma (1994): *A Handbook for Land Literacy: Participatory Resource Mapping Programme for Self-Reliant Panchayats*, Bharat Gyan Vigyan Samiti, New Delhi
 12. WASSAN (2001): *Issues Related to Dalits, Livelihoods and Watersheds*, Secunderabad

5 | Mapping

In this chapter we provide a brief introduction to mapping. The main aim of this chapter is for you to be able to understand why a watershed needs to be demarcated on a map, how this is done and how we calculate the area of a demarcated watershed. This will help you plan NREGA works on a watershed basis.

5.1 What is a Map?

A map is a representation of the earth or its parts on paper or a plane surface and drawn to a **scale**. In a map, information is displayed using symbols. Depending on need, different types of maps are prepared. However, for a representation to qualify as a map, it must have three attributes:

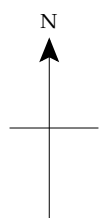

1. **Direction.** Direction tells you which way to hold the map. By convention, most maps are made with their top portion directed at North. Even when this is not the case, directions are always indicated in maps by an arrow

2. **Legend.** Legend gives a detailed description of the various signs and symbols contained in the map.

3. **Scale.** Distances on a map are smaller than the actual distances on the ground. Map distance, however, will be in proportion to the actual distance on ground and for any given map this proportion will not vary. The ratio of map distance to ground distance is called the **scale** of a map. Scale can be written in three ways:

1. **In words: Example-** 1:4,000 will be written in words as follows: “1 cm on map is equal to 4,000 cms or 40 m on ground”. This is how scale is usually shown on village revenue (*cadastral*) maps.
2. **Graphical scale:** Here, a straight line is divided into a number of equal parts and each such part represents an actual distance on the ground. To find out the ground distance from the scale, we measure one part of the scale.

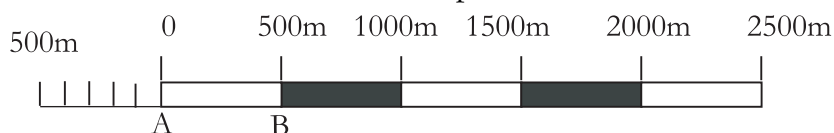

Supposing the distance between A and B in the scale above is 1 cm then,

$$1 \text{ cm} = 500 \text{ m}$$
$$\text{or, } 1 \text{ cm} = 500 \times 100 \text{ cm} = 50,000 \text{ cm}$$

The advantage of a graphical scale is that once it is placed on a map, whenever the map is expanded or reduced, its scale automatically changes.

3. **Representative Fraction (RF):** The ratio of map distance to ground distance can also be shown as a fraction:

$$\text{Representative Fraction (RF)} = \frac{\text{Distance on Map}}{\text{Distance on Ground}}$$

The RF shows that no matter what the unit of measurement is (centimetres or inches), the actual ground distance can be obtained by multiplying map distance with the RF. For example, let us assume that 1 cm on a map represents 2,500 metres on ground. The RF here will be:

$$1 \text{ cm on map} = 2,500 \text{ m on ground}$$

$$\text{or, } 1 \text{ cm} = 2,500 \times 100 \text{ cm on ground}$$

$$\text{or, } 1 \text{ cm on map} = 2,50,000 \text{ cm on ground}$$

$$1 \text{ m} = 100 \text{ cm}$$

$$\text{Thus, } RF = 1 : 2,50,000$$

This means that every centimetre on the map represents 2,50,000 centimetres or 2.5 kilometres on ground. Hence, a distance of 10 cm in the map would represent 25 kilometres on ground.

Question: Derive the RF of the cadastral map with a scale 16 inches = 1 mile?

Answer:

$$1 \text{ mile} = 1760 \text{ yard}$$

$$1 \text{ yard} = 36 \text{ inch}$$

$$\text{or, } 1 \text{ mile} = 1,760 \times 36$$

$$= 63,360 \text{ inch}$$

$$\text{Thus, } RF = \frac{16}{63,360} = \frac{1}{3,960}$$

$$\text{or } = 1 : 3,960$$

Question: An original map of the scale 1:10,000 was enlarged by 25%. What is the new scale of the map?

Answer:

The original scale of the map was 1:10,000. When the map is enlarged by 25%, the map distance increases by 25%. There is, however, no change in the ground distance. Hence, we have

$$1.25 \text{ cm on map} = 10,000 \text{ cm on ground}$$

$$\text{or, } 1 \text{ cm} = \frac{10,000}{1.25} = 8,000 \text{ cm on ground}$$

Thus, new $RF = 1 : 8,000$

Therefore, whenever the map is enlarged, the RF of the map also increases.

Remember that RF indicates only the ratio of *distances* and not of *areas*. When the scale of a map changes, the change in area will always be much more than change in the distances. Why? Think, for instance, about what will be the change in area when the scale of a map doubles?

5.2 Types of Maps

5.2.1 Sketch Maps



Such maps are often made so that we get a quick overview of the important aspects of the area (See Figure 5.1). These maps have legend and direction but may not always be drawn to scale. Reconnaissance maps for defence purposes and social maps made during PRA exercises are examples of these.

Figure 5.1: A sketch map of Baba Amte's Anandwan

5.2.2 Cadastral Maps

The term cadastral is derived from the French word, *cadastre*, meaning register of territorial property. These maps are made by governments to collect land revenue. Village revenue maps maintained by *patwaris* and village *patels* are cadastral maps (see

Figure 5.2). In addition to direction and scale, these maps also have detailed descriptions of boundaries of each plot, drainage lines, types of land use etc. These are usually drawn to a very large scale, such as 1:4000 ("16 inches = 1 mile"). These maps are used to depict information related to watershed development work, like soil type, ongoing or planned watershed interventions etc.

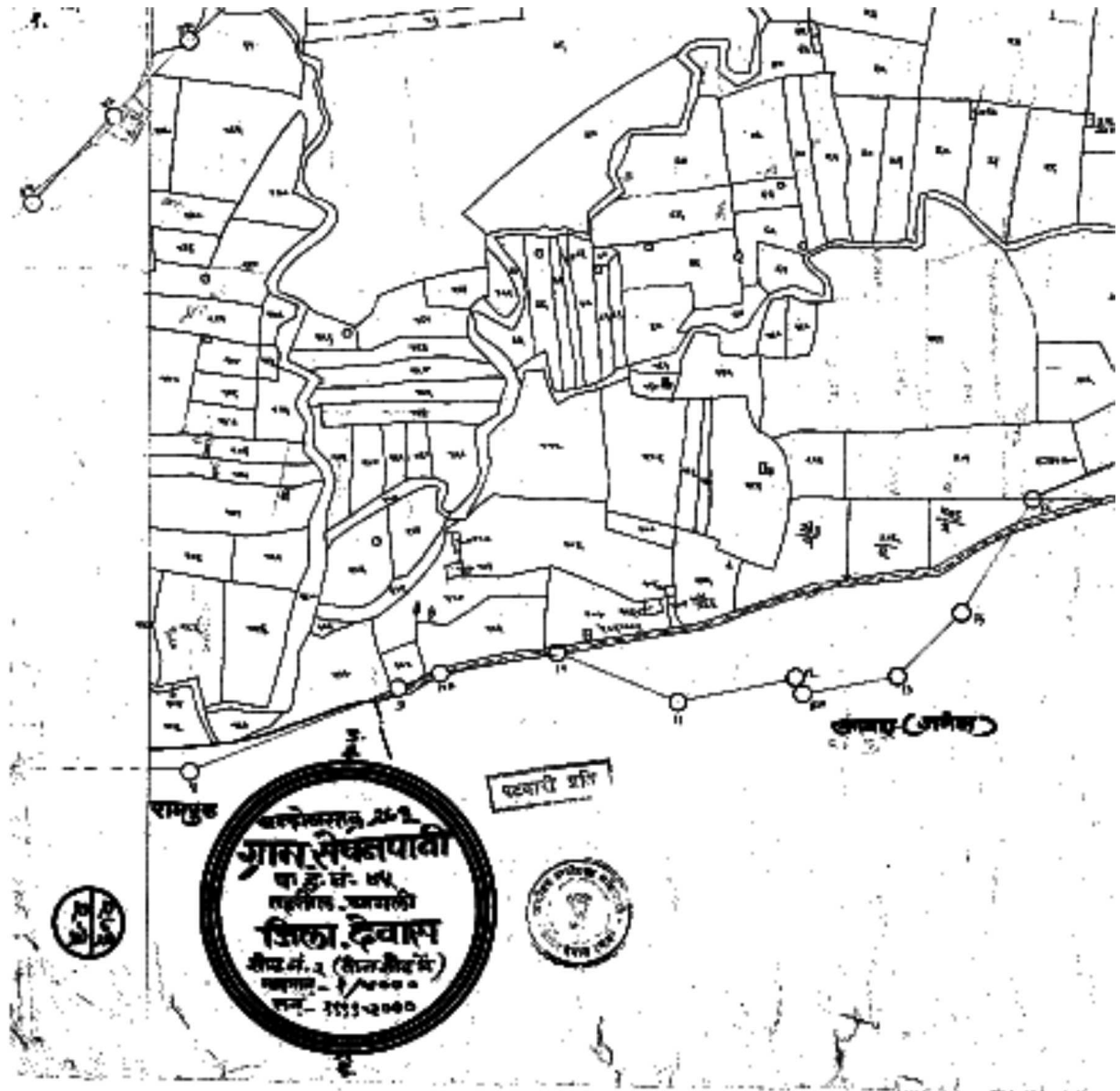

Figure 5.2: A section of a cadastral map. Such maps are used to demarcate revenue boundaries

5.2.3 Thematic Maps

Using some other map as its base, thematic maps give detailed information about one or a few themes, such as rainfall, climate, soil, drainage, vegetation, geology or hydrogeology. The scale of such maps is decided as per requirement of the detail to be shown (Figure 5.3).

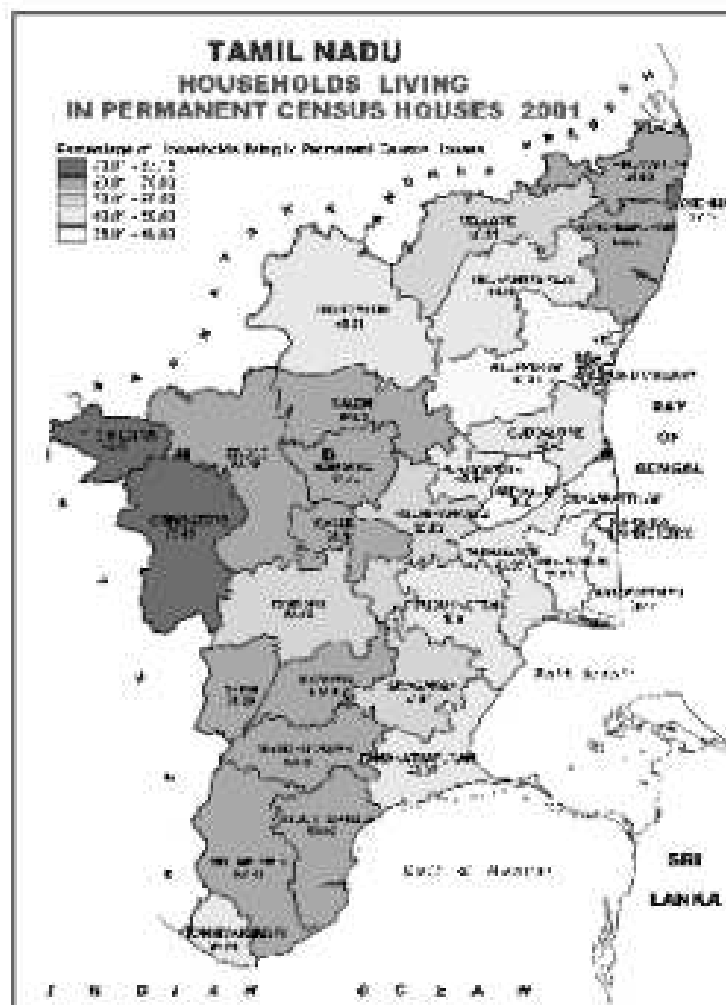

Figure 5.3: A thematic map from the Census of India, 2001. The map's theme is a depiction of households living in permanent census houses in Tamil Nadu

5.2.4 Satellite Maps

Recent advance in space science has allowed the possibility of obtaining maps developed from **satellite imagery**. Even though the accuracy of such maps is quite high since they do not depend on manual surveys, the information provided by them is recorded from such a long distance that it is able to capture only the surface features. Therefore, such maps should be used in conjunction with other maps.

5.2.5 Topographical Maps

Topographical maps provide information about the lay of the land. These maps are made after conducting detailed topographical surveys using levelling instruments. The special feature of topographical maps (or **toposheets**) is that along with direction, scale and legend, they also provide information about the relief of the land using contour lines (contour lines are imaginary lines joining points on the same elevation). Hence, these maps are of extreme value in planning and executing watershed works (Figure 5.4).

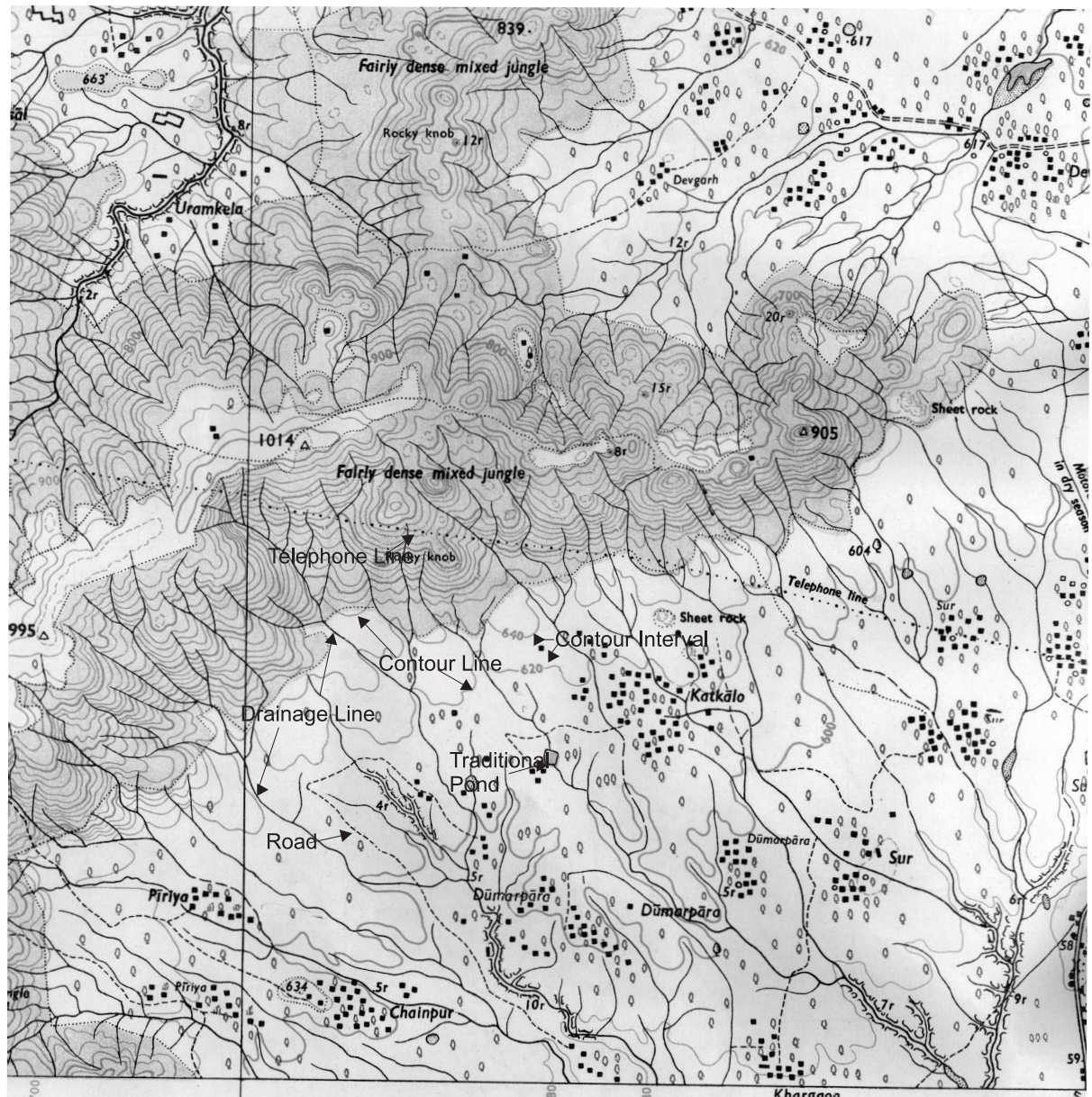

Figure 5.4: Toposheets give important information on contour lines, drainage lines, roads, settlements, forests, telephone lines, traditional water harvesting structures and more

Since the earth is a sphere, it has been divided into two equal parts known as the northern and the southern hemispheres. The latitude which divides the earth into these hemispheres is known as the Equator and is at 0° . Latitudes are marked 90° N and 90° S to the equator. In a similar manner the earth has also been divided into eastern and western parts by longitudes running from 0° to 180° E and 0° to 180° W. These longitudes are also known as Meridians. The meridian passing through the centre of the earth is called the Prime Meridian and is located at 0° .

The toposheet gives detailed information on contour lines, drainage, water harvesting structures, land use, villages and urban settlements, roads, railway lines, electricity and telephone lines etc. The vertical interval in a topographical map remains constant throughout. Using information given in a toposheet we can find out the elevation of any spot. We can also find out which areas are part of the ridge and which fall in the valley.

Toposheets are made on the basis of latitudes and longitudes. The location of any place on the earth is uniquely identifiable on the basis of two very important numbers – the latitude and

longitude. In reality, these are two angles measured in degrees ($^\circ$). Every part of India has been mapped by the Survey of India, using these latitudes and longitudes to classify the country into a grid. Toposheets are available mainly on 3 scales: 1:1,000,000, 1:2,50,000 and 1:50,000. For some special areas toposheets on 1:25,000 are also available.

5.3 Classification of Toposheets

To begin with, topographical maps were prepared for the whole country on a $4^\circ \times 4^\circ$ grid. These maps are known as 1\M maps and are drawn to a scale of 1:1,000,000 or approximately, $1'' = 16$ miles. 1\M maps are also given numbers such as 46, 53 and so on. Each $4^\circ \times 4^\circ$ grid is further subdivided into 16 grids of $1^\circ \times 1^\circ$. These maps are known as quarter-inch maps since they are on a scale of 1 inch = 4 miles (or $1/4$ inch = 1 mile) and have an RF of 1:2,50,00. These maps are numbered from A to P and are identified by a unique code such as 46D. In this code, 46 represents the 1\M grid code of which this map is a part.

Each of these maps is again divided into 16 equal parts, with $1/4^{\text{th}}$ of a degree in the longitude and latitude as the base. These maps are also called one inch maps as their scale roughly is 1 inch = 1 mile or 1:50,000. These are the maps most commonly used in watershed planning and area calculation. They are numbered from 1 to 16. Thus for example, 46D/7 is a map of a specific area at a scale 1:50,000 and which belongs to major grid code 46, sub-grid D and sub-sub-grid 7 (See Figure 5.5).

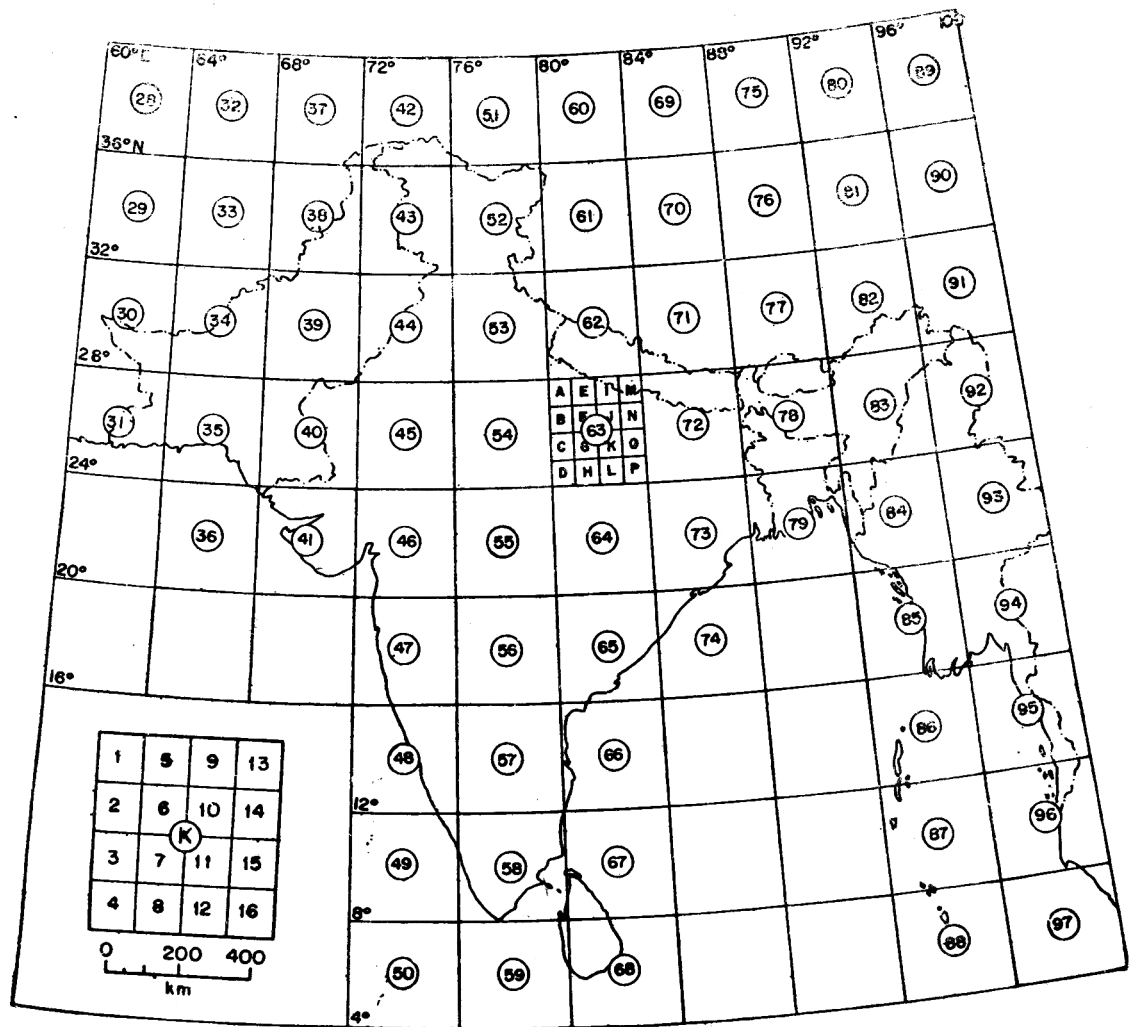

Figure 5.5: The whole country is divided into such a grid for the classification of toposheets

5.4 Using Toposheets for Watershed Demarcation

The area where a river “catches” its water is called its **catchment** or **watershed**. A watershed can be visualized as a landscape shaped unevenly like a bowl or basin. When it rains, water flows down from the top of this bowl to collect at the bottom. The undulating land area of any region forms several such units, each of which are called watersheds. The size and shape depends on the point chosen by us on the drainage line as the exit of the watershed. As we vary this point, the size and shape of the watershed also changes. Hence, unlike political units like a country, state or district, the area of a watershed changes with the selected unit. It is, therefore, necessary to demarcate a watershed with the help of **maps**. Toposheets are generally used to demarcate watersheds and calculate area.

5.4.1 Demarcating Watersheds: Howto?

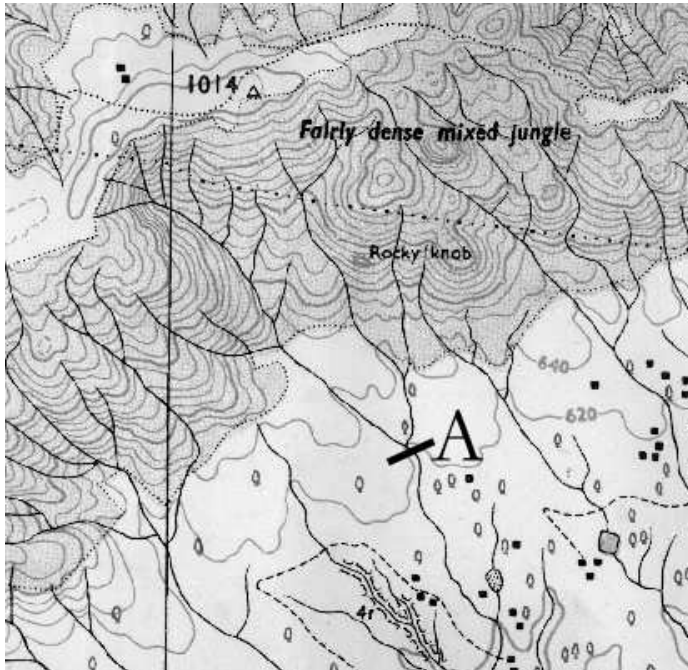

Figure 5.6: Watershed Demarcation: First choose an exit point

The First Step: For demarcating a watershed, we have to first identify the point with respect to which the watershed is to be marked (the **exit point**). In Figure 5.6, this is the point marked "A".

The Second Step: Then, we mark out drainage lines of various orders, which drain into this common point (see Figure 5.7). This must be done very carefully as the toposheet has many other lines indicating contours and roads, which appear similar to drainage

lines.

The simplest way to do this is to begin from the exit point (A) and move along the drainage line to its origin. To make things clearer, we can also mark out nearby drainage lines which do *not* drain to this common point. Different colours can be used to distinguish drainage lines belonging to our watershed from drainage lines outside our area. This helps to make sure that we are not leaving out any drainage lines which belong to our watershed and are conversely not including drainage lines which do not belong there.

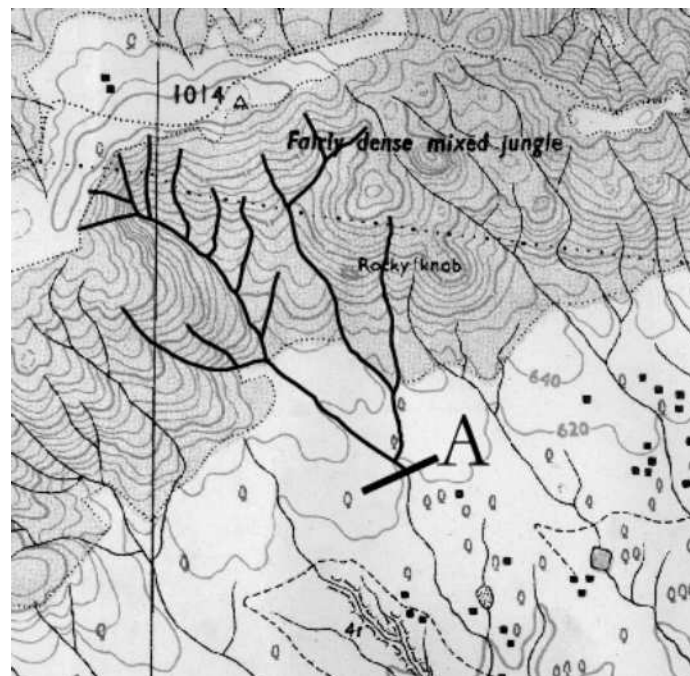

Figure 5.7: . . .Then mark the drainage lines

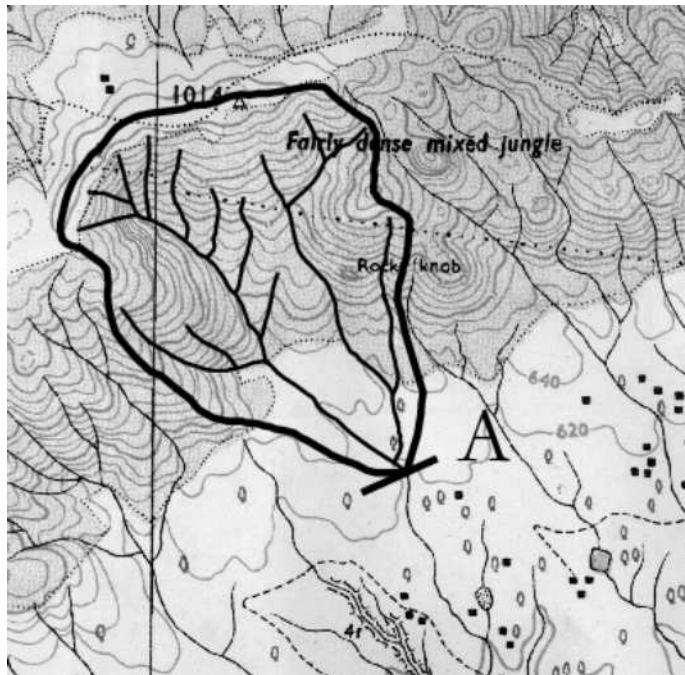

Figure 5.8: Finally, mark out the watershed boundary

selected watershed and separating the watershed from other watersheds. Since it never cuts across a drainage line, the defining feature of the ridge line is that water does not flow over it.

Precautions

- ✓ Remember to be very careful when outlining drainage lines, particularly when including drainage lines which fall in the watershed and leaving out those that do not.
- ✓ Remember that a toposheet shows several other lines (such as roads, telephone lines), which on a photocopy will look similar to a contour line. So exercise care.
- ✗ Ensure that the watershed boundary (the ridge line) never crosses any drainage line inside the watershed. If this has happened, be sure that it is a mistake and correct it

5.5 Calculation of Area of a Watershed

For calculating area of a watershed, we cannot use a pre-determined formula, since the shape of the watershed is irregular. However, using a translucent graph paper we can calculate the area of the watershed quickly and simply. Here is how:

First Step: Trace the boundary of the demarcated watershed onto a transparent graph paper (see Figure 5.9). This graph paper is divided into 1cm x 1cm squares which are again divided into 100 smaller, 1mm x 1mm squares.

The Third Step: Beginning from the exit point, draw a line around the drainage system, enclosing all drainage lines which drain to point A, and leaving out other drainage lines which do not drain to point A (see Figure 5.8). This boundary line will terminate at the exit point. This line demarcating the watershed boundary is called a **ridge line**. In other words, a ridge line is an imaginary line joining all points of higher elevation in a

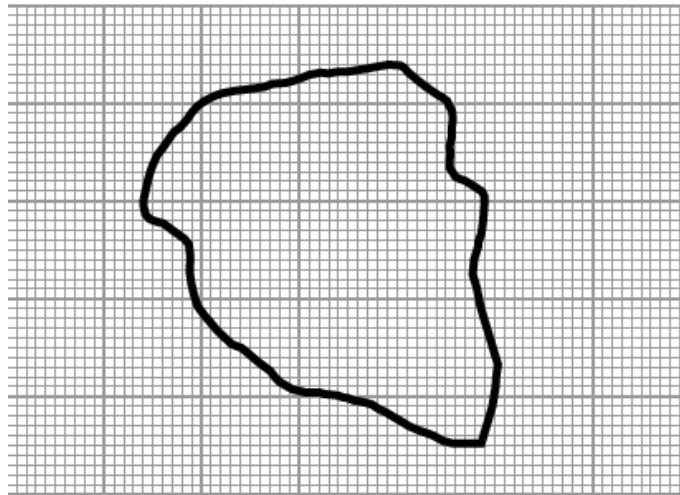

Figure 5.9: The watershed boundary traced out on a graph paper

Second Step: Count the number of whole 1 cm x 1 cm squares in the graph paper falling within the watershed boundary.

Third Step: In the leftover partial 1 cm x 1 cm squares, count the number of whole 1 mm x 1 mm squares

Fourth Step: The total number of 1 cm x 1 cm squares inside the watershed boundary:

$$\begin{aligned} \text{Total no. of } 1 \text{ cm} \times 1 \text{ cm squares} &= \text{No. of complete } 1 \text{ cm} \times 1 \text{ cm squares} \\ &+ \frac{\text{No. of } 1 \text{ mm} \times 1 \text{ mm squares}}{100} \end{aligned}$$

Fourth Step: The area represented by one square centimetre in a map is obtained from the scale of the map. Knowing this we can calculate the total area of the watershed.

Example 1: Suppose the scale of a map is 1:50,000. Therefore, every centimetre of map distance represents 50,000 centimetres or 500 metres of ground distance. Then area on ground:

$$\text{Area of a } 1 \text{ cm square on graph paper} = 1 \text{ cm} \times 1 \text{ cm} = 1 \text{ sq.cm}$$

$$\begin{aligned} 1 \text{ sqcm on graph paper} &= 500 \text{ m} \times 500 \text{ m on ground} \\ &= 2,50,000 \text{ sqm} \end{aligned}$$

$$\text{We know that, } 1 \text{ hectare (ha)} = 10,000 \text{ sqm}$$

$$\text{Thus, } 1 \text{ sqcm on graph paper} = \frac{2,50,000}{10,000} \text{ hectares} = 25 \text{ hectares on ground}$$

Remember that the area represented by 1 square cm will change with the change in the scale of the map.

Example 2: A watershed has been marked on a map with a scale of 1:25,000. The area of the watershed in the map comes to 68 square centimetres:

1. What is the area of the watershed?
2. What would be the area if the scale was 1:1,00,000?

We know that the scale of the map is 1:25,000. Thus,

$$1 \text{ cm of map distance} = 25,000 \text{ cm of ground distance} = 250 \text{ m on ground}$$

$$\begin{aligned} 1 \text{ sqcm on map} &= 250 \text{ m} \times 250 \text{ m} = 62,500 \text{ sqm} \\ &= \frac{62,500}{10,000} \text{ hectares} = 6.25 \text{ hectares on ground} \end{aligned}$$

$$\begin{aligned} \therefore \text{Area of watershed} &= 68 \times 6.25 \text{ ha} \\ &= 425 \text{ ha on ground} \end{aligned}$$

If the scale is 1:1,00,000, then:

$$1 \text{ cm of map distance} = 1,00,000 \text{ cm of ground distance} = 1,000 \text{ m on ground}$$

$$\begin{aligned} 1 \text{ sqcm on map} &= 1,000 \text{ m} \times 1,000 \text{ m} = 10,00,000 \text{ sqm} \\ &= \frac{10,00,000}{10,000} \text{ hectares} = 100 \text{ hectares on ground} \end{aligned}$$

$$\begin{aligned} \therefore \text{Area of watershed} &= 68 \times 100 \text{ ha} \\ &= 6,800 \text{ ha on ground} \end{aligned}$$

Example 3 (do it yourself): A watershed has been marked on a map with a scale 1:2,50,000. The area of the watershed in the map came to 125 square centimetres. What is the actual area of the watershed?

Answer: 78,125 ha

5.6 Calculation of Overall Slope of the Watershed

Relief is shown in a toposheet with the help of **contour lines**. As we have learnt in Chapter 3, contour lines are imaginary lines joining points of same elevation. Hence, no two contour lines can ever intersect. The value of a contour line shows the elevation of all points lying on it with respect to a benchmark. The contour value is usually expressed as metres (m) above **Mean Sea Level (MSL)**. For a toposheet of a specific scale, contour lines are drawn at specific **vertical intervals** (100m in a 1:2,50,000 sheet and 20m in a 1:50,000 sheet). This means that each contour line is drawn at a drop or rise of 100 metres and 20 metres on a 1:2,50,000 and 1:50,000 toposheet respectively. Because the vertical interval is kept constant, contour lines will come closer together on the toposheet when the slope increases. Conversely, the contour lines will move apart when slope decreases. Therefore, by looking at a toposheet, we can make out steeply sloping hilly areas, gently sloping valleys and flat land. We can also use a toposheet to quickly calculate the overall

slope of a watershed or its sections.

For this, we calculate the difference between the values of two contour lines. This is the vertical interval. Then we calculate horizontal distance by multiplying the map distance by the equivalent ground distance derived from the scale of the map. As we already know, dividing the vertical interval by distance, we get the slope.¹:

$$\frac{\text{Vertical Interval}}{\text{Horizontal Interval}} \times 100 = \text{Slope (\%)}$$

Example 4: In a toposheet of scale 1:50,000, Point A is on the ridge line and has a value of 320 metres above MSL and Point B located near the exit point of the watershed has a value of 240 metres above MSL. The map distance from A to B is 6 centimetres. What is the overall slope of the watershed?

We know that

$$\text{slope(\%)} = \frac{\text{Difference in elevation}}{\text{Distance}} \times 100$$

$$\text{Difference in elevation between A and B} = 320 \text{ m} - 240 \text{ m} = 80 \text{ m}$$

$$\text{Map distance between A and B} = 6 \text{ cm}$$

We know that in a 1:50,000 toposheet

$$1 \text{ cm} = 500 \text{ m}$$

$$\therefore \text{Ground distance between A and B} = 6 \times 500 = 3,000 \text{ m}$$

$$\therefore \text{slope} = \frac{80}{3,000} \times 100 = 2.7\%$$

Example 4: (do it yourself) On a 1:2,50,000, Point A is at an elevation of 800 m, Point B is at 400 m and Point C is at 300 m. the map distances are 5 cm from A to B and 6 cm from B to C. What is the overall slope of the watershed?

Answer: 1.9%

References

Singh, R.L. and Rana P.B. Singh (1991): *Elements of Practical Geography*, Kalayani Publishers, New Delhi

¹ There is some approximation involved here, as the ground distance is not actually the horizontal interval. To get the horizontal interval, we have to use the Pythagoras theorem and calculate the value of the base of the right-angled triangle of which ground distance is the hypotenuse.

6 | Technical Surveys of a Watershed

6.1 What is Surveying?

Technical surveys¹ are undertaken to find out the elevation of one location relative to that of another location whose elevation we already know. The point whose elevation we already know is often referred to as a “benchmark”, i.e., a sort of starting point from which the elevations of other points in an area can be calculated.

6.2 Why is Surveying Required?

Surveying is of utmost importance in the planning and execution of watershed works. Water flows from higher elevation to lower elevations. The momentum of water flow depends, among other things, on the difference in elevation between two points. Unhindered flow of water over the land surface causes soil erosion and land degradation. Watershed works try to regulate the momentum of water and minimise the damage caused. Hence, calculation of elevations and slopes is essential for deciding on the type of watershed structure appropriate for each location. In watershed development, we need to build a lot of structures such as small earthen dams, boulder checks, contour bunds, bench terraces, contour trenches, irrigation canals like *ghools* and so on. Consider, for example, small earthen dams. We need to estimate their height, slope and the volume of earth required to build them. In the case of boulder checks we need to know the correct spacing between successive boulder checks – i.e, how much above or below one boulder check should we build another? For contour bunds and trenches we need to identify points along the same elevation or points on the same contour. Surveying comes to our aid in all these tasks, by making them simpler and easier.

6.3 What is Required for Surveying?

There are several types of surveying instruments. Pipe levels and A-Frame are inexpensive, affordable and simple instruments. They are both lightweight instruments, which can easily be used by anyone with a rudimentary knowledge of arithmetic. They are useful where the distances to be covered during survey are not very long. For surveys involving longer distances, more sophisticated instruments like Hand Level, Abney Level, Dumpy level and Theodolites are used. These are slightly more expensive and need some more calculations on the readings taken.

¹This chapter is based on "*Aao Levelling Seekhen*", People's Science Institute, Dehradun

Clearly, the choice of which instrument to use depends on our specific needs and tasks at hand. More complex technical surveys (such as planning water harvesting structures like dams and marking out their full reservoir levels) demand greater accuracy at longer distances. For these an Abney Level or Dumpy Level should be used. Pipe levels and A-Frames may be used for simpler surveys as those required for contour bunds and trenches

6.4 The A-Frame

A-Frame is a simple wooden instrument, used mainly for identifying contour lines. The simplest form of an A-frame is two similarly sized wooden or steel poles laid up against one another and arranged in a 45-degree or higher angle. A third pole is kept horizontal, connecting these two poles. These poles are then tied together with rope or welded together.

6.4.1 Making an A-Frame

1. 3 bamboo poles each about 6-7 feet long,
2. fine thread
3. thick, strong rope
4. small, flat stone
5. small saw

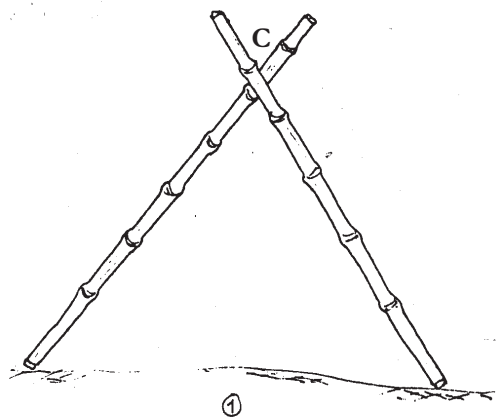

Figure 6.1: Two poles joined together to form the letter 'A'

Take two bamboo poles of nearly the same height. One end of each of these poles will go into the ground. These ends should be sharpened with a knife or a saw. Take care, however, not to sharpen them so much that the poles start sinking if kept on the ground. At the other end, leave about 6 to 8 inches length on both the poles and join the poles together in the shape of the letter 'A' as shown in Figure 6.1. Mark the point at which the two poles are joined together (point C in Figure 6.1).

Now with a saw, make a notch on each of the poles at the marked spot and fit the poles into each other at the notches. Then tie a rope tightly around this point so as to fasten the two poles together. Check to ensure that the pole assembly is not loose. If the rope is loose, take it off and fasten it once again, this time tighter. Let these two poles be called foot A and foot B of the A-Frame. Now place the third pole across these two poles to complete the letter 'A' as shown in Figure 6.3. Mark the points where this third

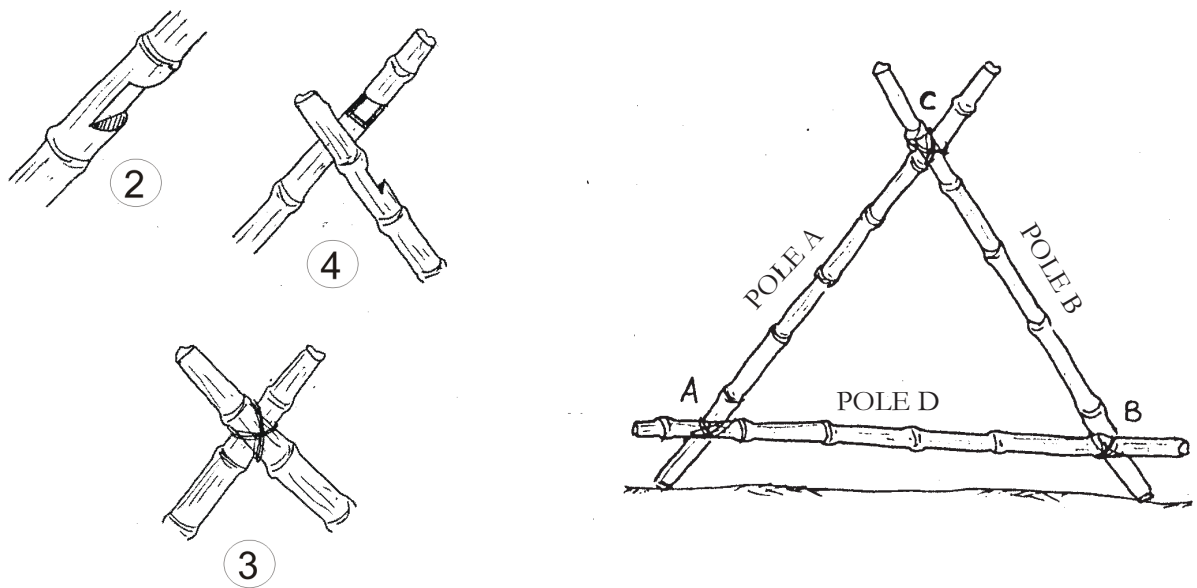

Figure 6.2: Make notches for a good fit

Figure 6.3: The 3 poles joined to form an A-Frame

pole meets poles A and B, as shown in the figure. Make notches on these two points and fasten the third pole on them with the thick rope as before. It should be obvious now how the A-Frame gets its name! Let the third pole be called pole D (Figure 6.3).

Take a thin thread and tie a small stone to it (see Figure 6.4). Tie the other end of the thread at point C of the A-Frame. Let the stone hang from point C in such a way that it is below the third pole (D), but remains suspended above ground level.

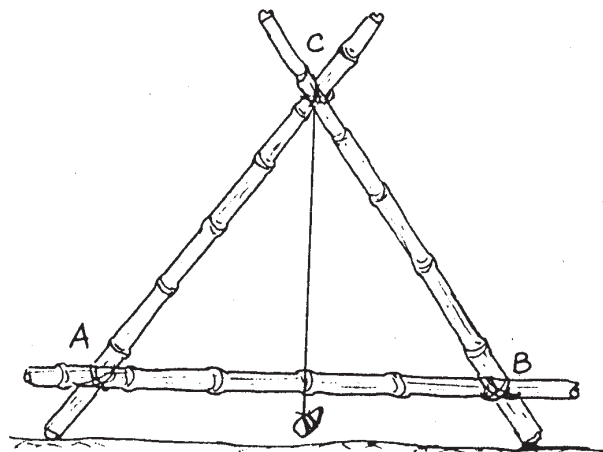

Figure 6.4: Hang a small stone from C

Place the A-Frame on the ground. Call the points where the two feet touch the ground X and Y. Note where the thread with the stone cuts pole D of the A-Frame.

Mark this spot as K (Figure 6.5). Now place the frame at X and Y again, but this time

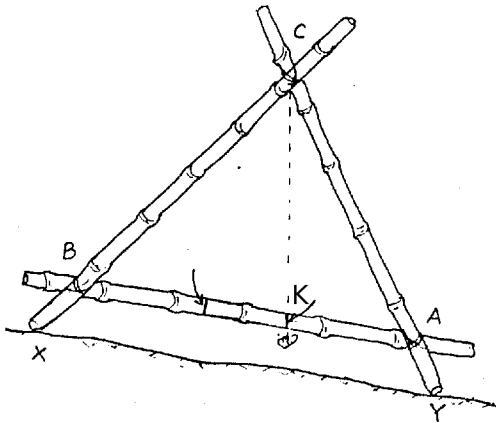

Figure 6.5: Marking point K

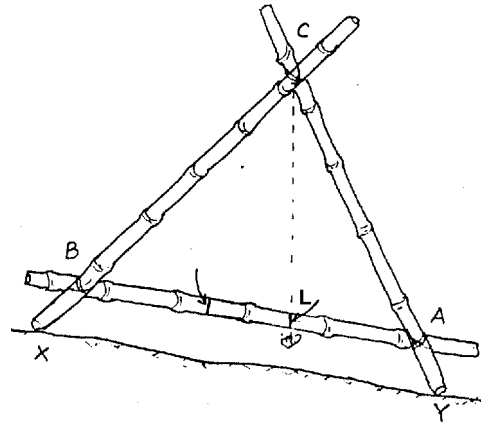

Figure 6.6: Marking point L

with the feet reversed (i.e., the foot of the A-Frame which was earlier on X should now be placed at Y and vice versa). Once again mark the spot where the thread with the stone cuts pole D. Call this spot L (Figure 6.6).

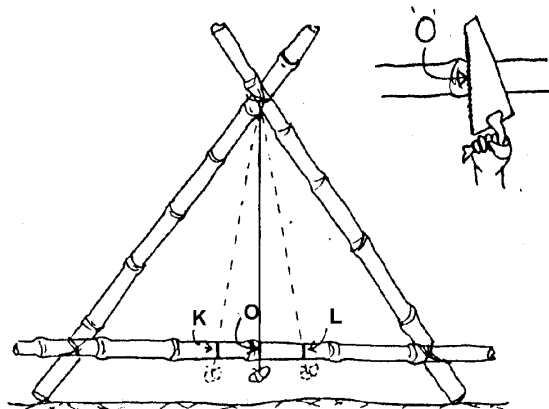

Figure 6.7: The point O at the centre of K and L

Then with another piece of thread find the midpoint between K and L and mark this point as O as shown in Figure (6.7). This point O is the centre point of the A-Frame. Deepen the mark at point O with a saw. Now erase the marks made at points K and L so that there are no mistakes when taking readings.

If the A-Frame is placed on level ground, the thread with the stone will always cut the third pole (D) at the centre point O. This is the principle on which the A-Frame works.

6.4.2 Marking Contours

Suppose you want to find the contour at some point P. Place foot A of the A-Frame at P. Place the other foot B on some point which at first sight seems to be at the same elevation as P. Watch the thread with the stone as it stabilises at the new position. If this thread intersects pole D of the A-Frame at its centre point O, then the new point is on the same contour as the earlier one. If however, the thread is to the right or left of O then keeping foot A where it is, shift foot B of the A-Frame to a new point nearby. Do

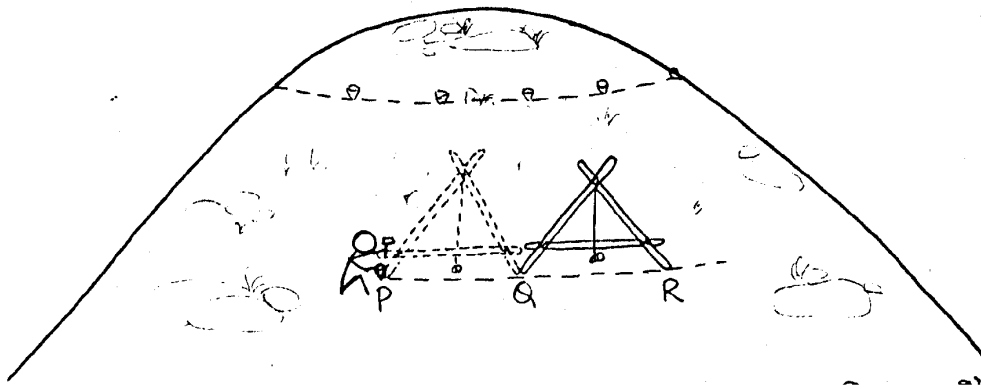

Figure 6.8: Marking Contours with an A-Frame

this repeatedly until you find a point where the thread intersects O. If such a point, say Q (see Figure 6.8), is found, then Q and P are at the same contour. Now fix a marker on the ground at point P and keeping foot B at Q, move foot A of the A-Frame forward to another point which seems to be at the same elevation as Q. When such a point (say R) is found through the above process, you have another point on the contour. Fix a marker at Q and move foot B forward. Repeat this process until the contour is marked completely. The marked contour can be used to plan structures such as contour bunds and trenches.

6.4.3 Measuring the Slope

We know that

$$\text{Slope}(\%) = \frac{\text{Height}}{\text{Horizontal Distance}} \times 100$$

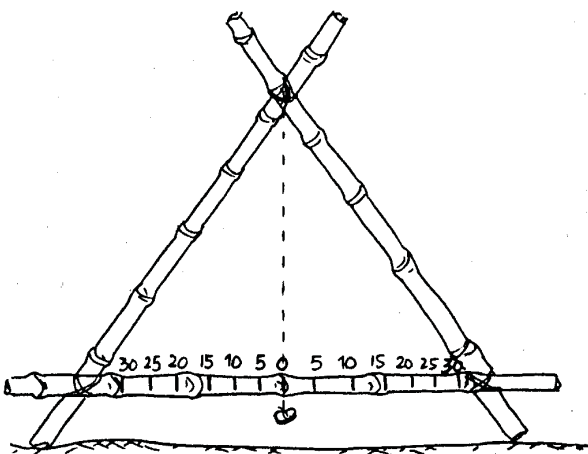

Figure 6.9: Slope Markers on an A-Frame

Going by the above equation, we need to know both the height and the horizontal interval in order to calculate the slope. First, keep the A-Frame on level ground with foot A touching some point X and foot B touching some point Y on the ground. Note that the thread with the stone intersects the middle pole of the A-Frame at O. This confirms that the A-Frame is indeed standing on

level ground. Now measure the distance between X and Y. Suppose this distance is 2 m (200 cms). Keep foot A on X and raise foot B 10 cms above the ground at Y. To raise the

A-Frame, you can use bricks or a wooden block or anything which can raise the foot 10 cms above ground level. This action will tilt the A-Frame. The thread and stone will slide away from point O and intersect the middle pole D at some other point. Make a mark at this point. This mark is the 5% slope marker (see Figure 6.9). To understand this go back to the above formula. The height is 10 cms and the distance between X and Y is 200 cms. Thus the slope is 5% because:

$$\begin{aligned} \text{Distance between X and Y} &= 200 \text{ cm} \\ \text{Difference in height between A \& B} &= 10 \text{ cm} \\ \therefore \text{slope} &= \frac{10}{200} \times 100 = 5\% \end{aligned}$$

Similarly in order to mark other slopes (10%, 15%, 20%, 25%), raise foot B commensurately. For a 10% slope foot B should be raised to a height of 20 cms, for 15%, to 30 cms and so on. Remember, of course, that if the distance between X and Y changes, so will the height by which foot B has to be raised.

In a similar way, we can make slope markers on the other side of point O too. With these slopes marked on the middle foot of the A-Frame, carry the A-Frame to where you want to measure slopes. Place the A-Frame on the ground and carefully observe where the thread and stone intersect the middle pole. Suppose the intersection point is midway between 10 and 15 then the slope is 12.5% and so on.

When measuring the slope with an A-Frame, always take readings at at least 5 points. The average of these readings is the slope of the area. For activities like land classification or land levelling, the slopes measured with an A-Frame are sufficiently accurate.

For example, suppose the average slope of a farm plot has to be calculated for purposes of land levelling. Take slope readings using an A-Frame. If the readings are 7, 9, 15, 12 and 7 then the average slope of the plot is:

$$\frac{(7 + 9 + 15 + 12 + 7)}{5} = 10$$

If the reading has been taken at 8 points, the average of these 8 points is the average slope of the farm.

6.4.4 Special Precautions

- ✓ The A-Frame should be fastened securely. If it is not, then the readings will be wrong. Making notches at the joints helps the A-Frame to remain securely together
- ✓ If bamboo is not available then wooden sticks of similar length can be used. In such a situation, holes can be drilled into the sticks and they can be fastened together with the help of nuts and bolts

- ✓ The thread and stone unit should be fastened at point C at the centre of both feet A and B of the A-Frame and should be free to swing like a pendulum.
- ✓ The stone should be relatively flat, otherwise it will keep getting untied and create a problem during measurement
- ✓ The feet of the A-Frame which have to be kept on the ground should not be too sharp or pointed since this will cause the A-Frame to sink into the ground and the accuracy of the readings will be adversely affected.
- ✓ Always keep the A-Frame straight at the time of taking readings, otherwise the stone and thread unit will not move freely and the readings may go wrong
- ✓ The thread on which the stone hangs should neither be too long nor too short. If it is too long, then it will touch the ground and if too short then it won't touch the middle pole and taking readings will be impossible

6.5 The Pipe Level

6.5.1 Material Used

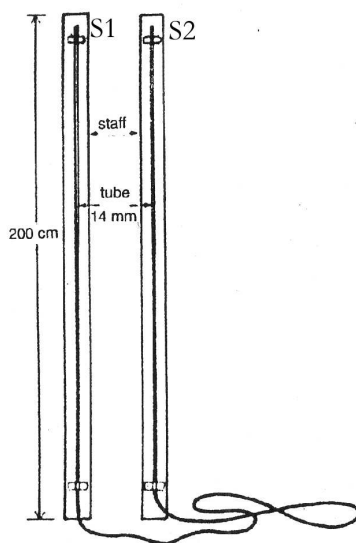

Figure 6.10: Pipe level is made of a pipe fastened on two wooden staffs

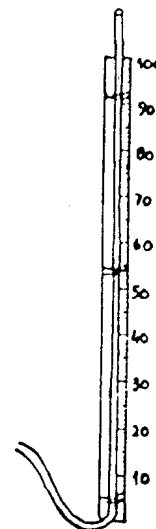

Figure 6.11: The scale's markings

1. Two wooden rulers or scales, each 1 m. long. If you cannot find them in the market, or cannot buy them, you can make them yourself
2. Thin, transparent pipe, about minimum 5 metres long.
3. Fine thread or transparent adhesive tape

6.5.2 Preparation

Tie one end of the pipe to one of the wooden scales as shown in Figures 6.10 and 6.11. You should tie it in such a way that about 6 inches of the pipe is jutting out. Fasten the pipe on the scale at 2-3 places with the help of the transparent tape or thread, so that the pipe stays close to the scale. In the same way, fasten the other end of the pipe on the second scale.

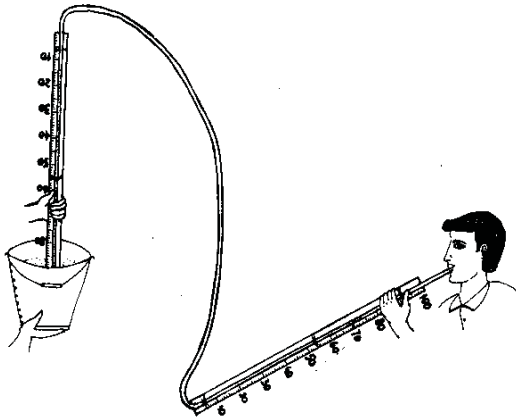

Figure 6.12: How to fill water in the pipe

Collect some water in a broad vessel like a bucket. Keep the vessel on a slightly elevated surface and dip one end of the pipe and scale into the water. Suck at the other end of the pipe until water starts flowing into your mouth (see figure 6.12). Remove the pipe from your mouth and make sure that there are no bubbles in the pipe. If you spot a bubble let it flow out of the pipe. Press both ends of the pipe with your thumbs and place them together on the ground. If the pipe is full of water on both ends, place one end slightly lower than the other and let some water flow out. At this point, if you keep both ends of the scale at the same spot, you should have about 50 to 60 cms of water in the pipe. Now the pipe level is ready to use.

Water which is stationary (not flowing), always attains the same level. It is this simple principle on which the pipe level works. In order to see this yourself,

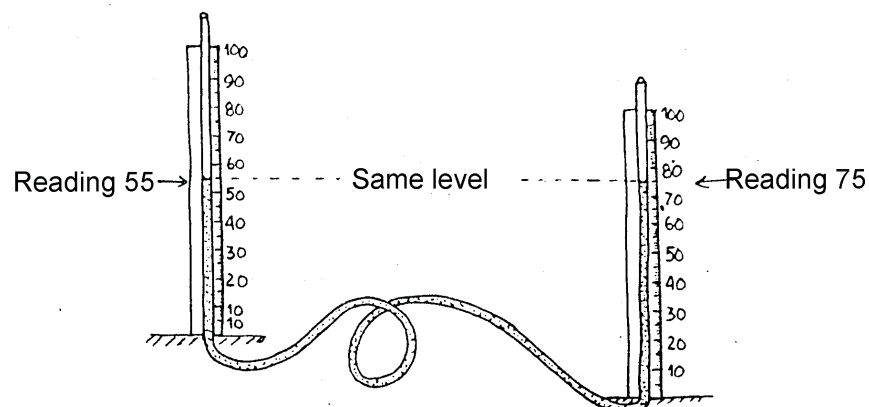

Figure 6.13: The level of water on both ends of the pipe is the same

place one scale on a slightly higher surface and the other scale on a lower surface. Compare the water levels in both ends of the pipe. Even if the readings on the two scales differ from each other, the level of water in the pipe on both ends will be the same (see Figure 6.13).

6.5.3 Marking Contour Lines

We can use the pipe level to mark contours. A contour is an imaginary line which joins together points on the same elevation. By marking contours in an area we can plan water harvesting and erosion control measures such as contour bunds, contour trenches, irrigation channels etc. Let us understand how to identify contours with a pipe level.

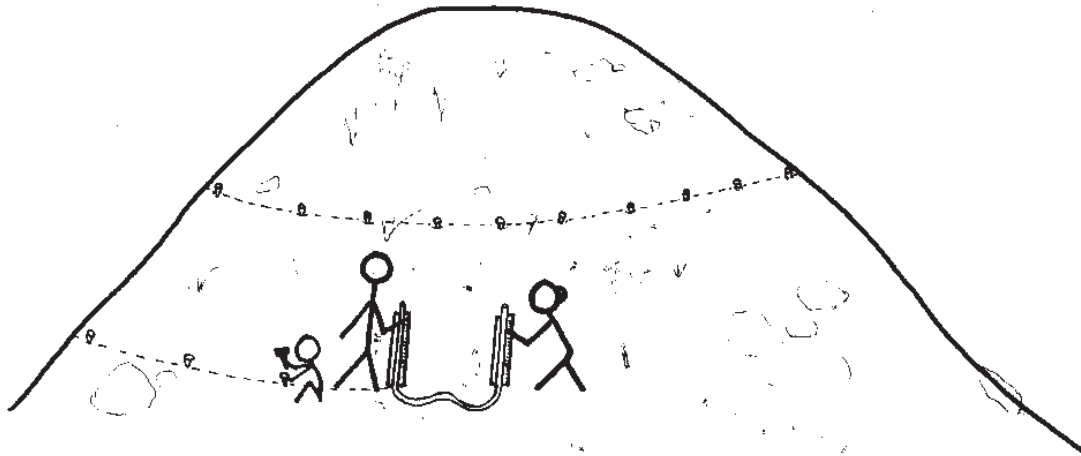

Figure 6.14: Using the pipe level to mark contours

Keep one scale of the pipe level (call it S1) on any one point in the area where you want to mark contours. Identify another point in the neighbourhood of the first one, which in your judgement, seems to be at the same elevation. Keep the other scale (call it S2) at this newly identified point. Now compare the water levels indicated by the two scales. If the water level reading in both scales is the same it means that the two points are at the same elevation. Remember that while viewing the readings, move from the bottom to the top of the scale and not from the top to the bottom. If the readings in the two scales are not equal, keep S1 at the same spot and shift S2 to another point. If the reading on S2 is higher than reading on S1, it means that S2 is at a lower elevation and hence S2 should move to a higher point. If reading on S2 is lower than S1, it means that S2 is at a higher elevation and hence S2 should move to a lower point. Keep doing this until the readings at the two points become equal.

Once you get the same reading in both scales, fix a peg in the ground at the spot where S1 was kept. Then keeping S2 where it is, move scale S1 from its original position. Put S1 at a spot which seems to be at the same elevation as S2 and take the readings in both scales. If they are not equal shift S1 to another spot according to the procedure described earlier. Keep doing this until the readings in both scales are the same. Then fix a peg in the ground at the spot where scale S2 was kept. Then keeping S1 where it is, move S2 to a new spot. This process should be repeated for as far as we want to mark

the contour.

The pegs that you have fixed all mark points at the same elevation. If you join these points together in a line you will get a contour line. Knowing this, we can plan to make contour trenches and contour bunds along the contour line which we have just identified.

6.5.4 Calculation of Slopes

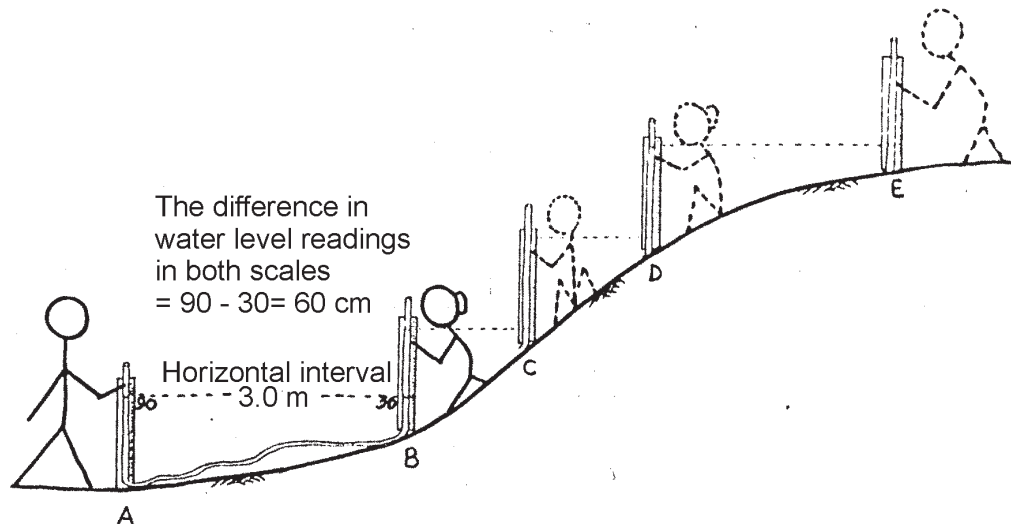

Figure 6.15: Calculating slopes with the pipe level

Suppose we want to calculate the slope as shown in Figure 6.15. Keep scale S1 of the pipe level at point A. Then move S2 to point B. Take the water level readings in both scales. Remember that the readings have to be viewed from the bottom to the top and not from the top to the bottom. Also keep in mind that point B should not be higher than the height of scale S1 otherwise water will spill out of the pipe at S1. This should be remembered particularly when we are trying to calculate the slope. Take down the water level readings on both the scales and calculate the difference between the two readings. This is the vertical interval or elevation between points A and B. Also find out the horizontal distance between the two points. This is known as the horizontal interval between points A and B. Now keeping S2 where it is (i.e., at point B), shift S1 to point C, which as you can see from the figure, is at a higher elevation than point B. Once again find out the difference in water level readings in S1 and S2. Also find out the horizontal interval between B and C. Repeat this procedure until you reach point E.

Now, sum up the differences in the water-level readings found out at each successive pair of points. That is, sum up the vertical intervals observed between successive pairs

of points. This sum is the vertical interval between point A and E. Similarly, sum up the horizontal intervals found between successive pairs of points. This sum is the total horizontal interval between point A and E. Now, divide this total vertical interval by the total horizontal interval to get the slope in percentage between points A and E.

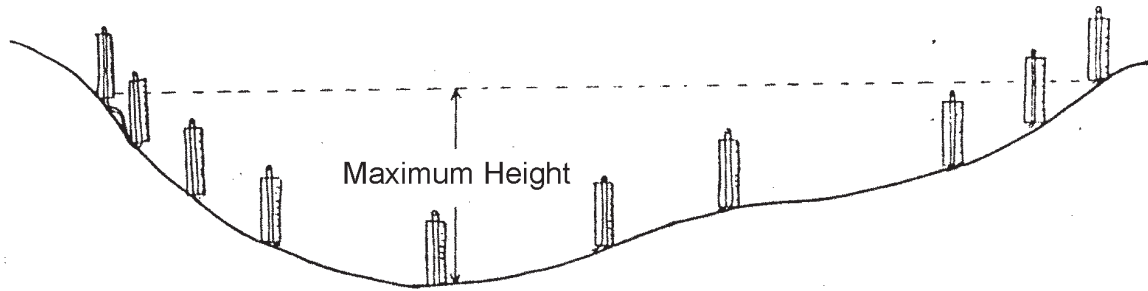

Figure 6.16: The pipe level can be used on a stream bed to find out the maximum height of a proposed dam

If we practice this on a stream or naala bed, we can find out the maximum height of the dam we propose to build on it. We can also find out the volume of mud which we will use in the construction of the dam (Figure 6.16)

Example 1: Calculating Slope

The difference in reading in the pipe level between points A and B is 60 cms. The horizontal distance is 3 metres. The difference in reading in the pipe level between points B and C is 44 cms. The horizontal distance is 1.8 metres. The difference in reading in the pipe level between points C and D is 38 cms. The horizontal distance is 2.2 metre. The difference in reading in the pipe level between points D and E is 43 cms. The horizontal distance is 3.2 metre. What is the slope from point A to D?

Now between A and E:

Difference in water level reading between A & B = 60 cm (0.6 m)

and horizontal interval = 3 m

Difference in water level reading between B & C = 44 cm (0.44 m)

and horizontal interval = 1.8 m

Difference in water level reading between C & D = 38 cm (0.38 m)

and horizontal interval = 2.2 m

Difference in water level reading between D & E = 43 cm (0.43 m)

and horizontal interval = 3.2 m

Total Vertical Interval between A & E = (0.60 + 0.44 + 0.38 + 0.43) = 1.85 m

Total Horizontal Interval = (3.0 + 1.8 + 2.2 + 3.2) = 10.2 m

Average slope between A and E = $\frac{1.85}{10.2} = 18.14\%$ or approx 18%

6.5.5 Special Considerations

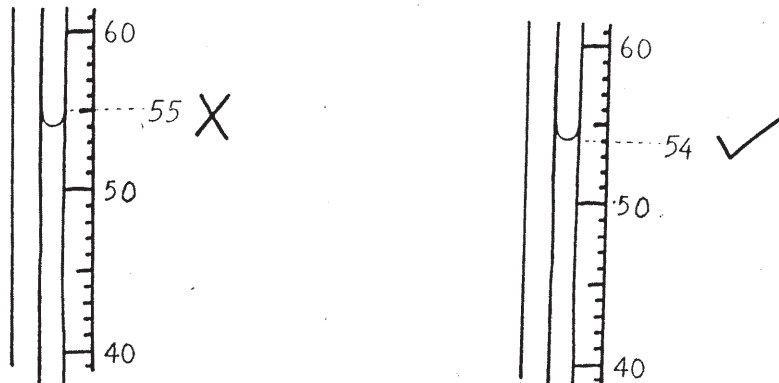

Figure 6.17: The wrong and the right way to take readings

- ✓ Water in the pipe will always take on a "U" shape (see figure 6.17). When taking the reading, always take the scale reading at the trough of the U-shape (Figure 6.17)
- ✓ When taking the reading always read from bottom to top of the scale rather than from the top to the bottom
- ✓ When using the pipe level, keep checking to ensure that it is not bent, folded or pressed at any spot. If it is, the readings will be wrong. This problem can sometimes also arise when it is too hot or too cold. So, remove the bend or press with your hand and smoothen the pipe before going on
- ✓ Check from time to time and ensure that there are no bubbles in the pipe. If there are, remove the bubbles and only then take the readings
- ✓ When it is time to shift one scale to a new point, keeping the other where it is, press both ends of the pipe with your thumb so that no water spills out. On moving to a new point to take the next reading, ensure that the thumb has been removed from both ends of the pipe.
- ✓ When moving the pipe from one place to another, ensure that both pipes are at the same level. In other words, keep both scales together and then move to a new

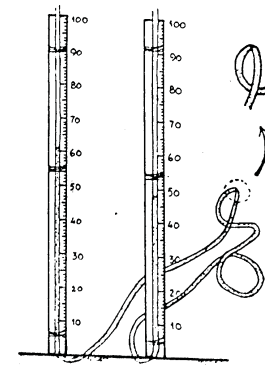

Figure 6.18: The pipe should not have any bends or folds

point

- ✓ When calculating the slope, keep in mind that one point should not be higher than the the height of the scale at the other point, otherwise water will start spilling out of the pipe at the lower point.

- ✓ After use, take all the water out of the pipe and keep everything safely.

6.6 The Dumpy Level

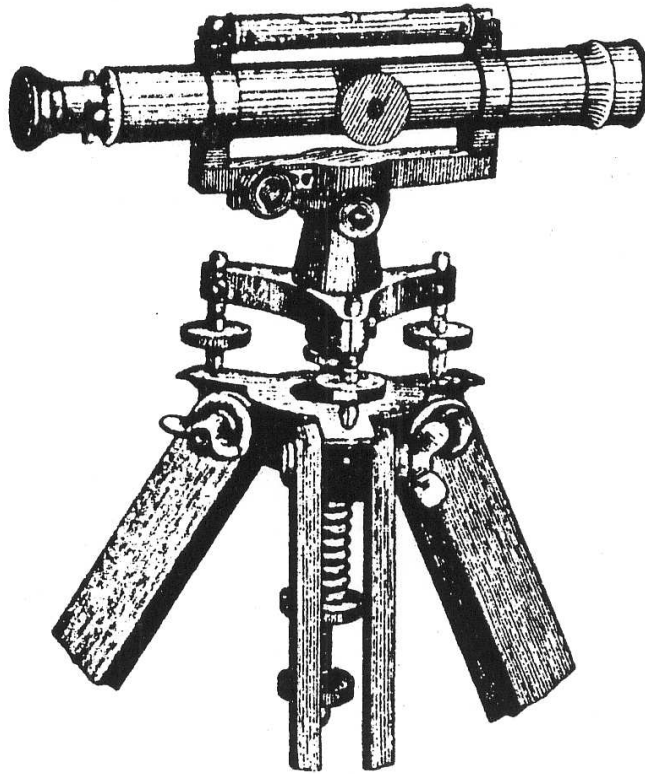

The dumpy level is the simplest and most inexpensive of the machines (such as alidades, theodolites etc.) used for surveying and levelling. It is easy to master and use and it is also easy to teach others how to use it. It is thus a natural choice as a surveying method for any watershed planning exercise.

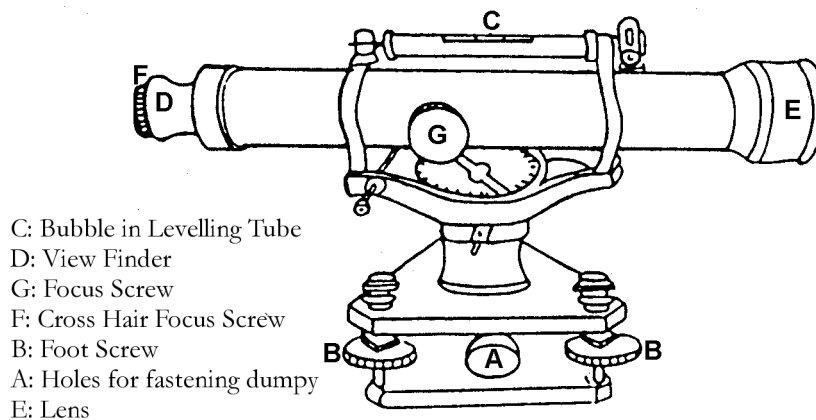

Figure 6.19: The dumpy level and its parts

6.6.1 Fixing the Dumpy Level on the Tripod

Spread out the tripod stand of the dumpy level on the ground such that the steel plate on top of the tripod is flat and level. Gently but firmly press the tripod down into the ground with your feet so that it does not move (Figure 6.20). The steel plate on top of the tripod has a hollow screw on it. On the dumpy you will see a hole (marked A in Figure 6.19). Place the dumpy so that the screw on the tripod fits into this hole and the dumpy is securely fastened onto the tripod.

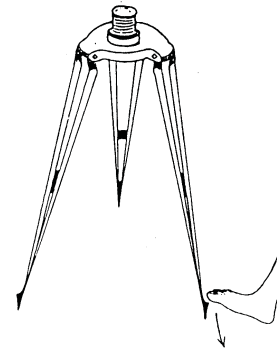

Figure 6.20: Press the tripod down with one foot

6.6.2 Levelling the Dumpy Level

Before using the dumpy it is critical to ensure that it is completely level (i.e. not tilted or slanted) itself. At the bottom end of the dumpy are 3 round screws (in Figure 6.21 these screws are marked B).

Half open these 3 screws. Then choose any 2 screws out of the 3. Rivet the dumpy around on the tripod so that it is aligned parallel to these two chosen screws (see diagram above). After this move the two screws clockwise or anti-clockwise. Keep rotating the screws until the bubble inside the dumpy (marked C in Figure 6.21) is completely centred between its two lines. This is stage 1 of the dumpy level.

After this, rotate the dumpy so that it is positioned in between these two initial screws and is, in a manner of speaking, intersecting the third (Figure 6.21). This is stage 2 of the dumpy. Notice that the bubble has probably lost its centre position. Now rotate only the third screw clockwise or anti-clockwise until the bubble in the dumpy

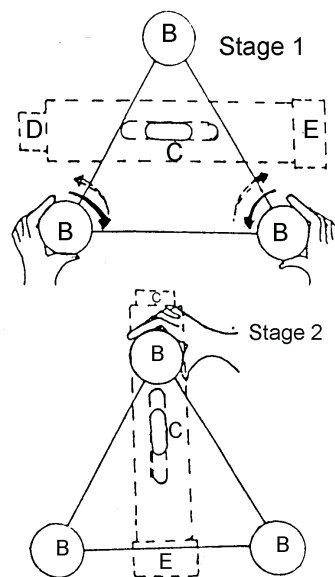

Figure 6.21: Levelling the dumpy

is centred once again. After this, keep repeating stages 1 and 2 of the dumpy until the bubble finds its centre spot *without* having to rotate the dumpy's levelling screws. When this state is achieved, the bubble will always remain centred no matter in which direction you move the dumpy. The dumpy level is now levelled and ready for use.

6.6.3 Setting the Dumpy's Telescope

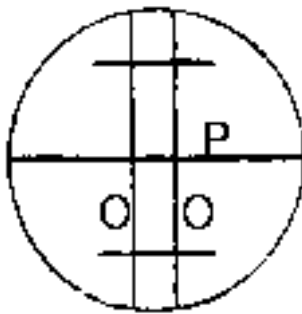

Figure 6.22: View from the dumpy's viewfinder

The dumpy has a built-in telescope. One end of the telescope (marked D in Figure 6.19) is the viewfinder. This is where we place our eye and see what we are trying to survey. The other end (marked E) is the lens on which is captured the image of what we are surveying. On looking through the viewfinder (D), we see three fine lines on the lens (E) – two of these lines run tall or upright (marked O in Figure 6.22) and one runs across (marked P)

If you are unable to see these lines clearly move the screw (marked F in Figure 6.19) on the viewfinder until you see the lines clearly. Once you have levelled the dumpy and adjusted its telescope, move the dumpy around very gently, lest the settings which you have so painstakingly made, are disturbed.

6.6.4 The Dumpy's Staff

The dumpy has a staff which is like a wooden scale. The staff has measurements notched on it. The numbers in the colour black are centimetre units and those in red are

metre units. This staff is capable of measuring a fairly wide range of elevations - between 1 centimetre and 4 metres with exactness upto 0.5cm.

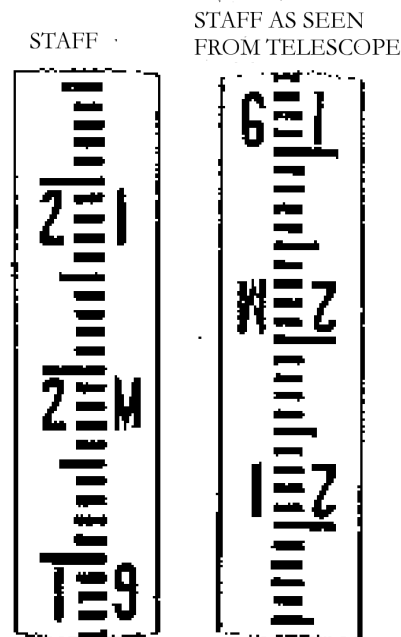

Figure 6.23: In older dumpy levels, the staff appears upside-down when seen from the viewfinder

In some dumpy levels of an earlier make, the scale appears upside-down or inverted when viewed from the viewfinder (see Figure 6.23). Reading here should be done very carefully. When we place the staff on the ground and view it with our bare eyes, we will see the numbers *increase* as we move our eye up the staff from the bottom. However, when we see the same staff through the viewfinder we will find the numbers *decrease* as we move up the staff, as though we have turned the staff upside down. The numbers also appear upside down. The number 9 will appear to be 6 and vice versa. So whenever you see '6' from the viewfinder, treat it as a '9' and whenever you see '9' from the viewfinder, always know that you have actually read '6'. And whenever you take measurements on the staff from the dumpy's telescope, always read the numbers as ascending from the top to the bottom.

6.6.5 Fine-tuning the Dumpy's Focus

On placing your eye at the viewfinder, you will see on the right of the dumpy a round screw (labelled G in Figure 6.19). This screw is for fine-tuning the focus of the dumpy so that you get a clear view. While looking through the viewfinder, adjust this focus screw with your right hand by moving it clockwise or anti-clockwise as required until you get a clear view of what you want to see.

6.6.6 Taking a Reading

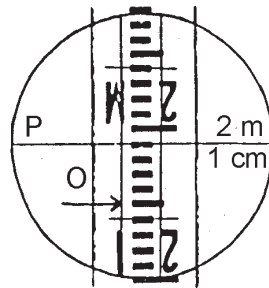

Figure 6.24: Taking readings with the dumpy level

Keep the staff at the point whose reading you want to take. Look through the viewfinder. You will be able to see the two upright lines (marked O in Figure 6.22 earlier). The staff should appear between these two lines as shown Figure 6.24. Take as an example the situation depicted in the diagram above. See the reading on the staff where the line running across (marked P) cuts the staff. The number is 2.01 m. Thus the reading is 2 metres and 1 centimetre. This is the way the reading is taken.

So to quickly recapitulate:

1. fix the dumpy on the tripod
2. level the dumpy by adjusting its 3 levelling screws so that the bubble is centred no matter in which direction you move the dumpy
3. adjust the focus of the telescope by rotating the focus screw.
4. place the staff at the spot whose reading you want to take
5. and shoot from the viewfinder!

6.6.7 Surveying with a Dumpy Level

6.6.7.1 Finding Elevations

First of all find a spot in the area you want to survey whose elevation from the Mean Sea Level is already known. Such a spot can be found by using a Survey of India topological map (also known as toposheet) for the area. Normally, you should be able to find at least one spot in the vicinity whose elevation will be marked on the toposheet. We refer to this spot as the “benchmark” or BM. The importance of the BM is that the elevation of other points can be calculated from it (Figure 6.25).

Now fix and level the dumpy on some location and place the staff on the BM. Take the reading on the staff at the BM. This process is referred to as “Backsight” or simply BS (see Figure 6.25) because the staff is placed at a spot whose elevation is already known. Normally, the staff should be kept at a distance of 10 to 200 metres from the dumpy so

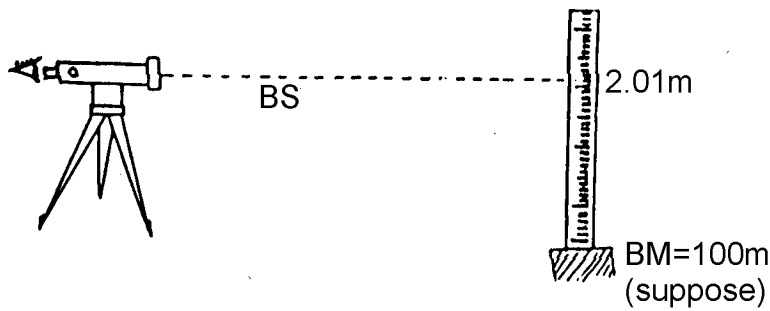

Figure 6.25: The dumpy's benchmark, BM

that the reading can be taken easily. Since the dumpy has been completely levelled, the height of its telescope is equal to the elevation of the reading on the staff visible through the viewfinder.

Suppose that the elevation of the BM is 100 m. And the reading on the staff visible from the viewfinder is 2.01 m. Then, the elevation of the dumpy = $BM + BS = 100 + 2.01 = 102.01$. This is also called the Height of the Instrument (HI).

The dumpy will remain levelled so long as it remains on the same spot, even if it is rotated around in any direction to sight different spots. Thus, the HI also will remain the same so long as it remains on the same, original spot. You can use this fact to calculate the elevations of various points in the vicinity as shown in Figure 6.26 below.

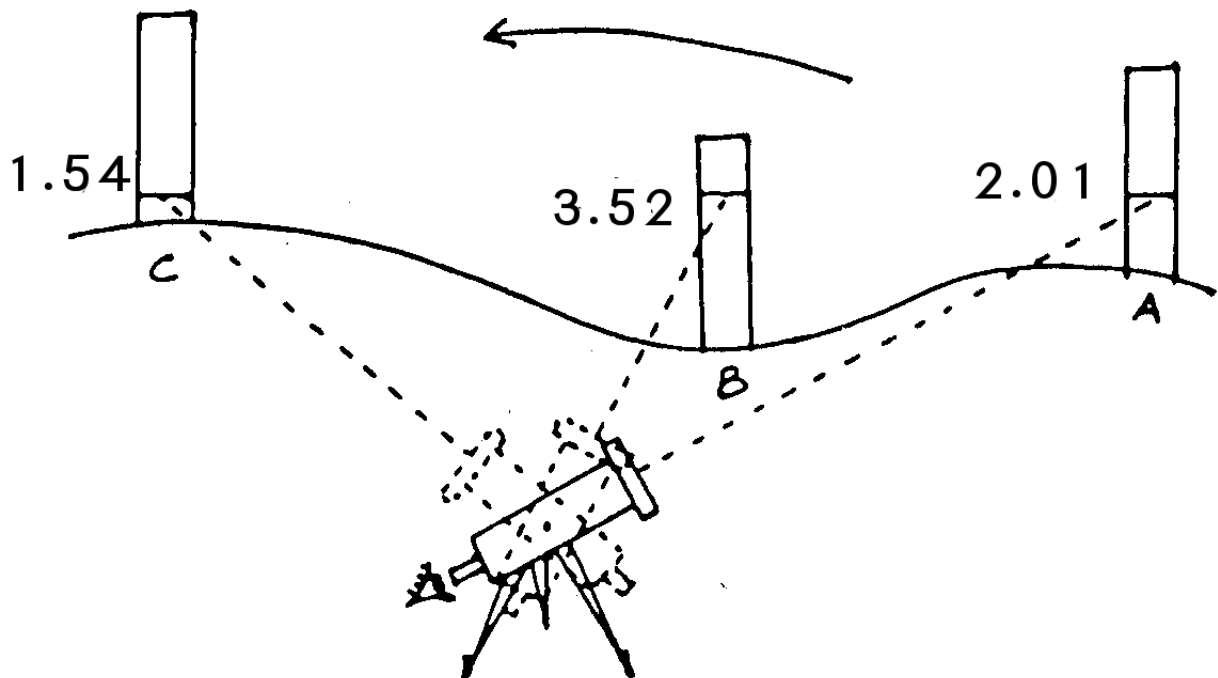

Figure 6.26: Finding out elevations with a dumpy

Figure 6.26 above shows the BM marked as Point A, showing a reading of 2.01. There

are two other points – point B which is in a dip (or lower than A) and point C, on a hump (or slightly higher than point A).

Notice how the reading on the staff is relatively higher if the staff is kept on B which is in a dip. Likewise notice how the reading is a little lower when the staff is placed on point C, the higher point.

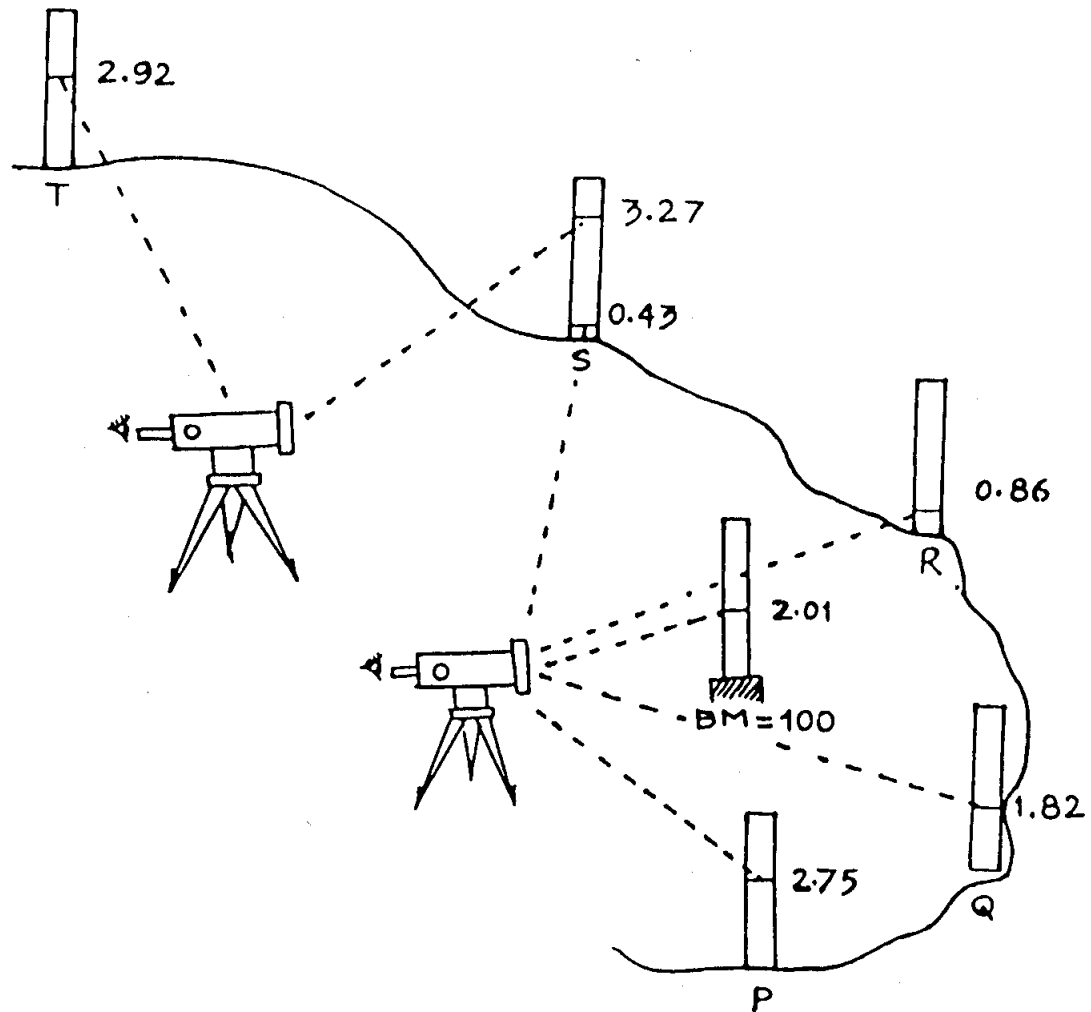

Figure 6.27: Taking readings of other spots

Now remove the staff from the BM and place it at some spot whose elevation you want to calculate. In the figure below, there are 5 such points (P, Q, R, S and T). Let us see how to calculate their elevations (Figure 6.27)

First keep the staff at P and take the reading. Suppose the reading is 2.75 m.

$$\begin{aligned} \text{Then elevation at P} &= \text{Elevation of dumpy (HI)} - \text{reading on staff} \\ &= 102.01 - 2.75 = 99.26\text{m.} \end{aligned}$$

Now keep the staff at Q. The reading here is 1.82.

$$\begin{aligned} \text{Then elevation at } Q &= \text{Elevation of dumpy (HI)} - \text{reading on staff} \\ &= 102.01 - 1.82 = 100.19\text{m}. \end{aligned}$$

Now keep the staff at R. The reading here is 0.86

$$\begin{aligned} \text{Then elevation at } R &= \text{Elevation of dumpy (HI)} - \text{reading on staff} \\ &= 102.01 - 0.86 = 101.15\text{m}. \end{aligned}$$

Now keep the staff at S. The reading here is 0.43

$$\begin{aligned} \text{Then elevation at } S &= \text{Elevation of dumpy (HI)} - \text{reading on staff} \\ &= 102.01 - 0.43 = 101.58\text{m}. \end{aligned}$$

6.6.7.2 Shifting the Position of the Dumpy Level

Now, if you feel that it is not possible to take a reading on point T from the dumpy, let the staff remain on S. This reading of the staff is known as “Foresight” or simply FS. At this point the position of the dumpy needs to be changed.

Keep the dumpy at a point near to point T and level the dumpy all over again. Point S will now serve as the new BM, since we know its elevation (101.58 m). After levelling the dumpy, take a reading by keeping the staff at S. This is now the new Back Sight (BS). Now find out the height of the dumpy (new HI) at this spot as follows:

$$\begin{aligned} \text{Elevation of dumpy at the new spot} &= \text{Elevation of } S + \text{Reading at } S \\ &= 101.58 + 3.27 = 104.85 \text{ m}. \end{aligned}$$

Now keep the staff at T and take a reading. Suppose the reading is 2.92 m.

$$\begin{aligned} \text{Then elevation at } T &= \text{Elevation of dumpy (HI)} - \text{reading on staff} \\ &= 104.85 - 2.92 = 101.93\text{m}. \end{aligned}$$

In the same way, we can find out the elevations of other points.

Do It Yourself

Calculate RL of the points A to E using the following information given below. RL of the BM is 280 m above MSL

No.	Readings on Staff (Fore Sight)	Readings on Staff (Back Sight)
BM		1.75
A	2.45	
B	3.75	1.30
C	2.15	
D	2.85	1.45
E	1.95	

6.6.8 Calculating Distances using Dumpy Level

Dumpy level can also be used to measure distances approximately and calculate slopes quickly. In a dumpy level, two **stadia hairs** are placed above and below the crosshair at equal distances. These are called the Upper and Lower stadia. After levelling the instrument and taking a reading on the crosshair, readings are also taken on the upper and lower stadia hairs. These can be called Upper Reading (UR) and Lower Reading (LR) respectively and the crosshair reading can be called the Middle Reading (MR). Note that if the instrument is level, the difference between UR and MR will be the same as that between MR and LR. The difference between UR and LR is then multiplied by a constant (for most instruments it is 100) and that is the horizontal distance between the instrument and the point where the reading is taken.

For instance, if the UR and LR at point A in the above example are 2.60 m and 2.30 m respectively, then the distance between the instrument and A is,

$$2.60 - 2.30 = 0.30 \text{ m} \times 100 = 30 \text{ metres.}$$

Do It Yourself

The Dumpy Level readings (m) at 2 points A and B are as follows:

Reading	A	B
Upper Reading (UR)	1.62	1.68
Middle Reading (Crosshair)	1.60	1.65
Lower Reading (LR)	1.58	1.62

Calculate the approximate slope between A and B (*Answer = 2.5%*)

6.6.9 Marking Contours

As we already know, a contour is an imaginary line joining different points which have the same elevation. Suppose the BM is 100 m. And you want to mark a contour at 120 metres. Move the staff away from the dumpy towards points which are higher until you get a point whose elevation is 120 metres. Suppose the reading at this point is 1.52 metres. Now move the staff to another point where the reading is 1.52 metres. If the reading is more than 1.52m., then move the staff to a higher point. If it is less than 1.52 m., move the staff towards a lower point or a dip. Repeat this until you find a point whose reading is exactly 1.52 m. This is the second point is at the same elevation (120 m) and hence is on the contour line at 120m. Now find a third point and then a fourth and so on.

This method is also useful in identifying the **submergence area** of water storage

structures. What you want here is the contour line at FRL. For this, place the staff at the base of the exit weir. Take the reading. Suppose this is 2.5 m. Then, move the staff and get points at regular intervals where the reading is 2.5 m. Mark these points with wooden poles or with ash and join them up. We get the submergence area of the water storage structure. With experience and knowledge of the area, this can be accomplished quite simply.

6.6.10 Transferring the Benchmark

A permanent BM (a point with a with known elevation above MSL) can normally be located on a toposheet. However, it is likely that this BM is located far away from the watershed and it is difficult for a micro-level survey to begin the survey from there. In such cases, any permanent feature of the land, such as a bridge, building or a pillar can be taken as a temporary benchmark and its elevation can be assumed to be 100. All elevations during survey (like in examples given above) will be calculated with respect to this benchmark. Soon after the survey, the RL of the temporary benchmark should be identified through dumpy level surveys starting from the permanent benchmark. Assume, for instance, that the RL of the permanent benchmark is 360 m. Through the dumpy level survey we find that the RL of the temporary benchmark (assumed to be 100 m) is actually 280 m above MSL. An addition of $(280-100) = 180$ m should be made to all elevations worked out through the earlier survey. This process is called transferring the benchmark.

6.6.11 A Simple Way of Testing the Dumpy Level

Keep the dumpy on one spot. Now select any two points which are 30 m away from this one. Find out the difference in elevation between these two points. Now shift the dumpy to some new position. Again measure the difference in elevation between the same two points from this new position of the dumpy. If there is a difference in both readings, then there is something wrong with the dumpy.

7 | Ridge Area Treatment: Contour Trenches

Contour trenches are a simple, low-cost method of checking the velocity of runoff in the ridge area of any watershed. A contour trench is a trench dug along a contour line. A contour line is an imaginary line that joins together points of the same elevation. Digging a trench along a line that is at the same level increases the chances of containing runoff for a longer period of time within the trench. If trenches were not to follow a contour, such digging could actually increase the possibility of soil erosion because there would be a rise in the velocity of runoff following upon an increase in the slope of the land. In the ridge area of a watershed a contour trench is a simple and inexpensive solution to slowing down surface runoff and reducing soil erosion.



7.1 Objectives

- * Slowing down the velocity of runoff
- * Checking soil erosion
- * Improving local soil moisture profile

Contour trenches are constructed in the ridge area of a watershed. Rainwater, which falls in this area flow unchecked carrying with it eroded soil into the flatter portion of the watershed - the "valley". This silt gets deposited into reservoirs and ponds, reducing their life. Thus, any water harvesting work undertaken in the valley will become meaningless unless appropriate measures such as contour trenching are undertaken to control runoff and soil erosion in the ridge. Contour trenches collect the rainwater that falls in the ridge area. This way the soil moisture profile in the area adjacent to the trench is improved.

Along with the water, eroded fertile topsoil also gets deposited in the trench. It is, therefore, important to combine trench construction with plantation.

7.2 Location

The best way to decide on what to do in the ridge area of a watershed depends upon the slope.

1. **If the slope is more than 25% do not make contour trenches** - If the slope in the ridge area is 25% or more, the best form of treatment is plantation or protection of grasses, shrubs and trees, appropriate and native to the area. This is because for contour trenches to be effective on such high slopes, they will have to be constructed at very close intervals, which could end up causing more soil erosion due to excessive digging.
2. **If the slope is less than 10% do not make contour trenches** - If the slopes are less than 10%, even then contour trenches are not the best measure. This is because in such a situation, in comparison to contour trenches, contour bunds are a more effective means of checking runoff and soil erosion. In a contour bund, water not only stops in the excavated portion but also against the bund. Therefore, wherever possible, contour bunds must be constructed in place of contour trenches. However, on very high slopes, it is not possible to make contour bunds since there is a great danger of the bunds breaking.
3. **If the slope is between 10% to 25% make contour trenches** - Given the above considerations, contour trenches are most appropriate where the slope of the ridge area lies between 10-25%.

7.3 Distance between Successive Rows of Trenches

The distance between two successive rows of trenches depends on the volume and velocity of runoff they are expected to handle, which in turn depend on:

1. The quantum of rainfall: the greater the rainfall, the lesser the distance
2. The permeability of the soil: the more permeable the soil, the greater the distance
3. The slope of the land: the greater the slope, the lesser the distance
4. The vegetative cover: the lesser the vegetative cover, the lesser the distance

That is, as the volume and velocity of runoff increase due to any reason given above, the trenches should become more closely spaced. In several watershed programs,

however, a particular procedure has been adopted for fixing the intervals between trenches:

"The vertical interval between contour trenches is fixed at 1 meter".

Thus, with a constant vertical interval of 1m, the contour trenches would be spaced at a horizontal interval of 20m on a 5% slope and 10m on a 10% slope. However, one must not follow this rule blindly without taking into account the catchment area that each contour trench has to handle. For example, on high slopes one may end up making too many trenches even though there is very little water that each trench needs to handle. And on low slopes, too few trenches are made which are unable to intercept most of the runoff, since each trench is expected to do much more than its fair share of storage. In practice, one must fix the maximum and minimum horizontal interval between two successive contour trenches. For example, one can stipulate that:

- *On high slopes, the trenches should be close to each other but never closer than 10 m.*
- *On low slopes, the trenches should be far from each other but never farther than 30 m.*

Similar rules can be devised for each area depending on the rainfall.

7.4 Design of Contour Trenches

Contour trenches are always dug half a metre deep and half a metre wide. Certain precautions are needed while digging these trenches. One of the key questions is what to do with the mud excavated from the trenches. It is very important to spread this mud evenly and a little away, downstream of the trench. This

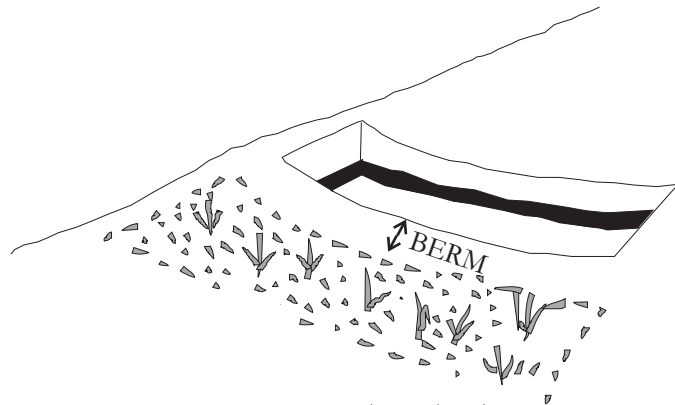

Figure 7.1: A trench with a berm

distance is called *berm* and is generally kept at 20 cm. Care should be taken not to pile up this mud. The danger is that the rapidly flowing water will breach this pile at its weakest point. All the water will then begin to flow through this breach. Over time a gully will form at this point, increasing the rate of soil erosion rather checking it. It would also help if you plant grass seeds in this soil. Otherwise, there is a danger that a flash flood could carry this soil and fill up the trenches in the rows downstream, defeating the very purpose of digging these trenches.

1. *Depth*: 50 cm
2. *Width*: 50 cm
3. *Berm*: The mud excavated is spread out 20cm away, downstream of the trench. This gap between the trench and mud is called the *berm*. This distance is essential so that this mud does not fill up the trench again.

7.5 Layout of Contour Trenches

1. Measure the slope in different parts of the ridge area
2. Mark out areas with slope between 10-25% for the lay-out of contour trenches
3. Begin with the longest section within this area

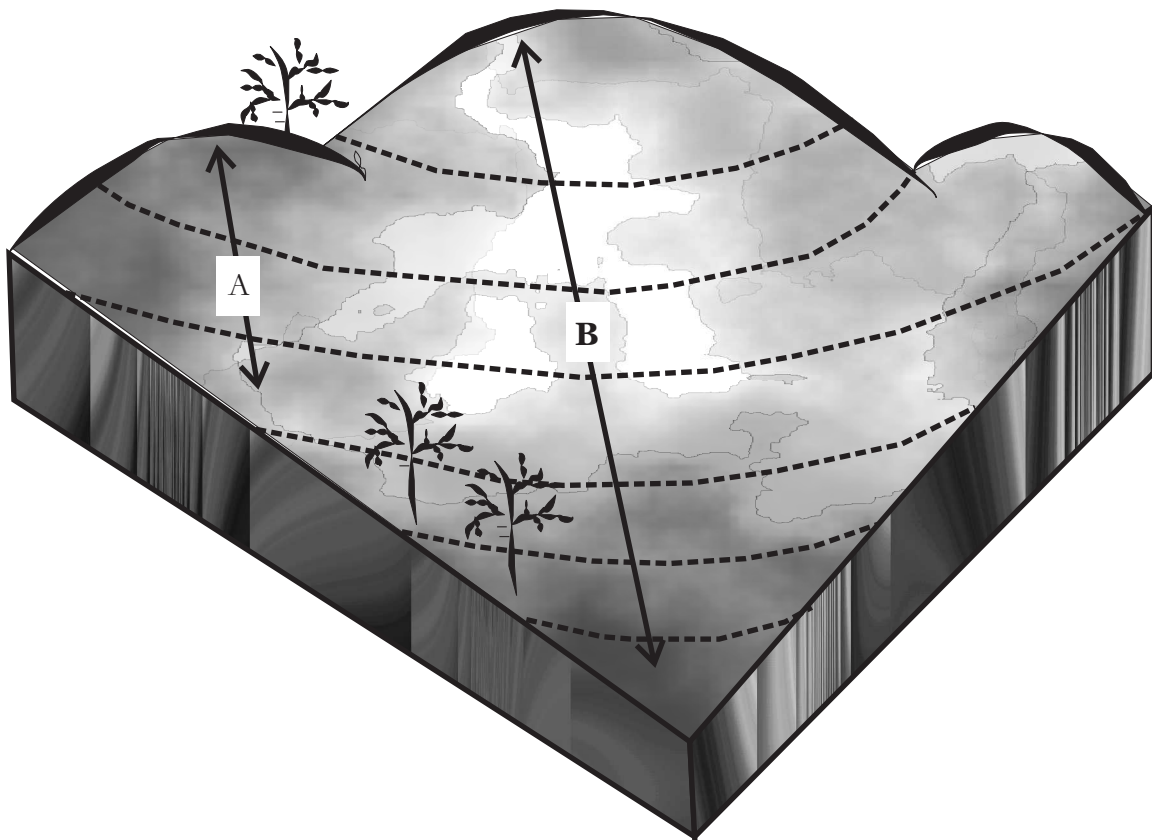

Figure 7.2: Layout should be made beginning with the longest section

In Figure 7.2, Section A is 30m long. If we begin laying out contour trenches of 15m successive intervals from this section, we will only be able to dig 2 rows of trenches in the entire area. On the other hand, if we begin laying out contour trenches from Section B (which is 90m long) we will be able to dig 6 rows of trenches. Thus, only when you start from the longest section will you be adequately cover the ridge area with contour trenches. Of course, we must also bear in mind that the interval between

rows of trenches will narrow at the steeper slopes. Make sure that this interval does not become less than the minimum you have stipulated for your area.

1. Now, draw a straight line with wet lime from the top of the slope to the bottom of the slope
2. On this straight line, mark points at the decided interval between successive contour lines
3. Starting from each mark, demarcate the contour line
4. Dig trenches along these contour lines
5. Depending on the specific conditions (such as thick vegetation, rocks etc.), leave gaps in the excavation from place to place
6. Make sure that the water left out of one line of trenches is stopped by the line of trenches below
7. Undertake plantation as appropriate

7.6 Staggered vs. Continuous Trenching

Over time, experience of watershed programs has shown that it is better to *stagger* the digging of contour trenches. This is because it has been found that invariably errors have been made in contouring over long distances. If the contour trench is not level and by mistake sloped, then water starts to flow from the high point to the low point, cutting a path and increasing soil erosion. Therefore, instead of making trenches continuously, they should be made in a staggered, discontinuous manner (see Figure 7.3).

Dig a trench 4m long on a contour line. Give a gap of 4m. Dig another 4m trench along the contour. And so on, along this particular contour. Then, come to the next contour line. Begin digging in a stretch which covers the gap left in the higher contour line. The gaps in this contour line should fall below the trenches in the higher contour line. In this way, we maximize the runoff harvested by the trenches. In other words, chains of staggered trenches should be made along successive contour lines so that water left by one line of trenches is captured by the lower line. And so on . . .

In areas where there is an abundance of trees and vegetation, gaps in excavation are in any case essential to allow space for the roots of the trees to spread. Also, where there are hard rocks underneath the soil, trenches must be staggered.

7.7 Planning Contour Trenches

The planning and designing of contour trenches involves answering two questions:

1. how much of the rainfall do we want to catch? and
2. what length of trenches should there be to catch this amount?

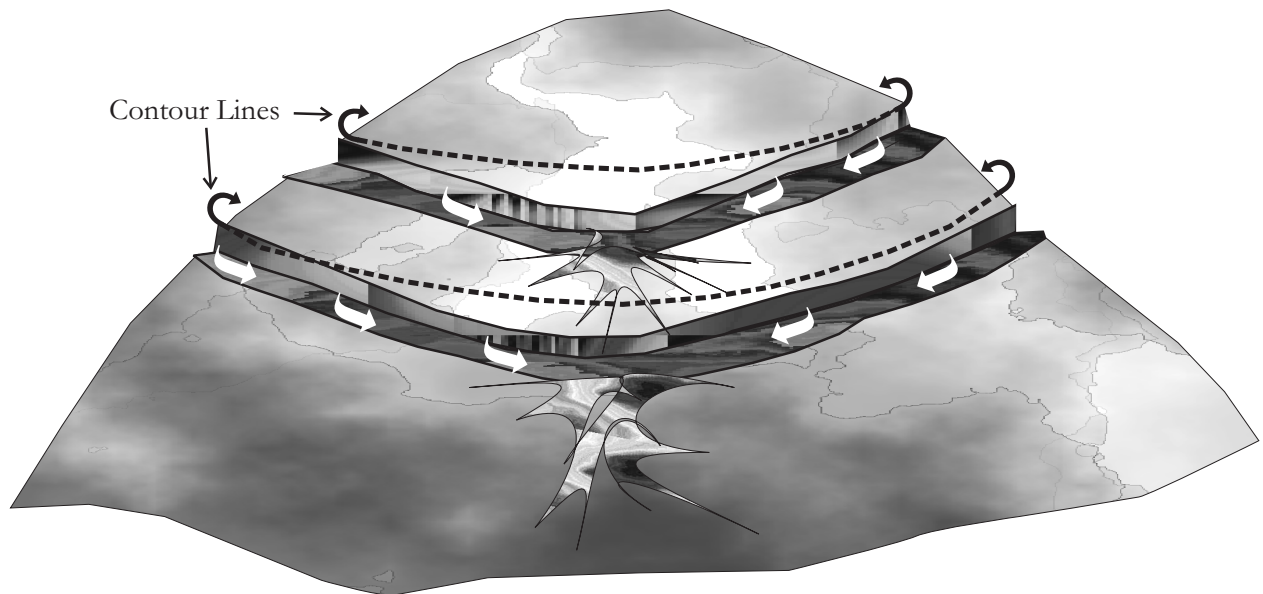

In continuous contour trenches there is a possibility of going off the contour line in which case water will flow along this sloping channel and spill out, creating gullies

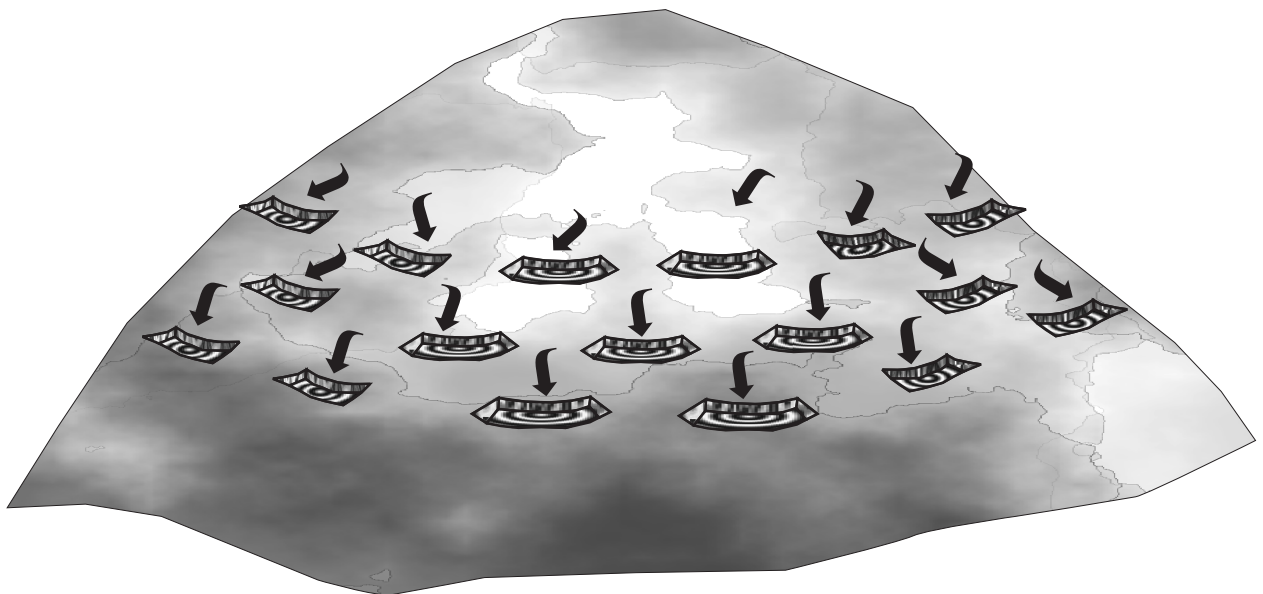

Staggered trenches minimise the risk of going off the contour and are therefore safer

Figure 7.3: Staggered Vs. Continuous Trenches

7.7.1 How much of the rainfall do we want to catch?

To answer this question we need to estimate how much of the rain that falls will flow and run-off (Q), after some has been soaked up by the soil, or stopped by vegetative cover. As explained in the chapter on basic concepts, the percentage of annual rain we seek to harvest in any structure depends on the size of the structure. In a small structure like a contour trench, it is best (most cost-effective) to assume that we are trying to harvest the maximum rain likely to be received **in a day**. As we know:

$$Q = C \times R \times A$$

where C = runoff coefficient

R = quantum of daily rainfall and,

A = the area of the ridge from which the runoff is received

We must remember that we do not want to catch *all* the runoff in the contour trenches of the ridge area. Suppose we only want to stall 70% of the runoff (Q_1) then

$$Q_1 = Q \times \frac{70}{100} = 0.7Q \text{ sqm}$$

7.7.2 How long should trenches be to catch this amount?

Contour trenches are always dug 0.5 metre wide and 0.5 metre deep. This means that the cross-section area of a contour trench is always $0.5 \text{ m} \times 0.5 \text{ m} = 0.25 \text{ sq.m}$. However, we will also need to bear in mind that the trenches will fill up more than once in any spell of rainfall. The more permeable the soil in which the trenches are dug, the more number of times will the trenches fill with water. For instance, in a black cotton soil or hard rock area, the number of times the trenches fill up will be lower than the number of times they fill up in highly permeable soils such as mooram or sandy soil. The number of refills will be higher in the early part of the season when soils are drier than in the later part of the monsoon when the soils are already relatively saturated. In practice, we assume that the number of refills (f) is somewhere between 1.5 and 3.

Thus, to calculate the total length of trenches required to halt 70% of the run-off in an area of one hectare, we divide Q_1 (70% of the quantum of run-off) by the cross-section area (A_t) of the contour trench multiplied by the number of refills (f):

$$\text{Thus, length of contour trenches in metres } (l) = \frac{Q_1}{(A_t \times f)} \text{ metres}$$

7.7.3 How to layout these trenches in the ridge area

This involves finding out the distance between successive rows of contour trenches and the number of such rows.

We know A , the area where trenches are to be dug. We have also determined the total length of the contour trenches (L) to be dug.

The distance d between two successive rows of contour trenches will be

$$d = \frac{A}{L} \text{ m.}^1$$

As we explained in the section on design, we begin layout of contour trenches from the longest section of the ridge area. In order to decide the number of rows of contour trenches (N) required, we divide the length of the longest section of the ridge area (L_r) by the distance between successive rows of contour trenches (d)

$$N = \frac{L_r}{d}$$

7.8 Solved Numericals

Example 1: Planning continuous contour trenches

Design a continuous contour trench in an area of 25 hectares in Indore. The run-off co-efficient of this area is 0.4. The daily rainfall is 100 millimetres and only 75% of the run-off has to be stored in the contour trench. Assume that the trench gets 2 refills in a day. The longest section of the ridge area is 2500m. Make a plan for continuous contour trenching in mooram.

Solution

Step 1 ■ Finding out the quantum of run-off to be harvested

$$Q = C \times R \times A, \text{ where,}$$

Q = runoff in cubic meters

C = coefficient of runoff

R = daily rainfall in metres

A = area taken up for design in square meters

¹ In effect we have approximated the ridge area to be shaped as a rectangle. This is a practical thumb-rule which works reasonably well on the ground

We know that 1 hectare = 10,000 sq.m.

$$\text{Thus } A = 25 \text{ ha} \times 10,000 \text{ sqm} = 2,50,000 \text{ sqm}$$

$$R = 100 \text{ m} = 0.1 \text{ m}$$

$$\begin{aligned} \therefore Q &= \underbrace{0.4}_C \times \underbrace{0.1 \text{ metres}}_R \times \underbrace{2,50,000 \text{ square metres}}_A \\ &= 10,000 \text{ cum} \end{aligned}$$

Since the contour trench has to catch only 75% of the run-off then

$$Q_1 = 10,000 \times \frac{75}{100} \text{ cum} = 7,500 \text{ cum}$$

Step 2 ■ Finding the Length of Continuous Contour Trenches required

Now we need to calculate total length of contour trenches that will be required to store 7500 cum. Usually a contour trench is made 0.5 m wide and 0.5 m deep. Each such trench has a cross-section area A_t :

$$\begin{aligned} A_t &= 0.5 \text{ m} \times 0.5 \text{ m} \\ &= 0.25 \text{ sqm} \end{aligned}$$

Since this trench gets filled twice in a day, length of contour trenches

$$L = \frac{Q_1}{(A_t \times f)} = \frac{7,500}{(0.25 \times 2)} = 15,000 \text{ m}$$

Step 3 ■ Distance between successive rows of contour trenches

The distance d between two successive rows of contour trenches is:

$$d = \frac{A}{L} = \frac{2,50,000}{15,000} = 16.67 \text{ m}$$

Step 4 ■ Number of rows of contour trenches (N)

In order to decide the number of rows of contour trenches (N) required, we divide the length of the longest section of the ridge area (L_t) by the distance between successive rows of contour trenches (d)

$$N = \frac{L_t}{d} = \frac{2,500}{16.67} = 150$$

Solution to Example 1

$$\text{Quantum of Run-off} = 7500 \text{ cum}$$

$$\text{Length of the Contour Trenches} = 15,000 \text{ m}$$

$$\text{Number of rows of contour trenches} = 150$$

$$\text{Distance between rows of contour trenches} = 16.67 \text{ m}$$

Example 2: Planning Staggered Contour Trenches

Design staggered contour trenches in a 25 hectare area of Indore. The run-off co-efficient of this area is 0.4. The daily quantum of rainfall is 100 mm and only 75% of the run-off has to be stored in the trenches. Each trench gets filled twice in a day. The length of one trench is 5 meters and the distance between two trenches in a row is 2.50 meters. The longest section of the ridge area is 2500m.

Solution

Step 1 ■ Finding out the Quantum of Run-off

$$Q = C \times R \times A, \text{ where,}$$

$$Q = \text{runoff in cubic meters}$$

$$C = \text{coefficient of runoff}$$

$$R = \text{daily rainfall in metres}$$

$$A = \text{area taken up for design in square meters}$$

We know that 1 hectare = 10,000 sq.m.

$$\text{Thus } A = 25 \text{ ha} \times 10,000 \text{ sqm} = 2,50,000 \text{ sqm}$$

$$R = 100 \text{ m} = 0.1 \text{ m}$$

$$\begin{aligned} \therefore Q &= \underbrace{0.4}_C \times \underbrace{0.1 \text{ metres}}_R \times \underbrace{2,50,000 \text{ square metres}}_A \\ &= 10,000 \text{ cum} \end{aligned}$$

Since the contour trench has to catch only 75% of the run-off then

$$Q_1 = 10,000 \times \frac{75}{100} \text{ cum} = 7,500 \text{ cum}$$

Step 2 ■ Finding the Number of Contour Trenches required

Usually a contour trench is made 0.5 m wide and 0.5 m deep. We know that each trench is 5m. long. Thus, the volume of each trench is

$$\begin{aligned} V &= L \times B \times H \\ &= 0.5 \text{ m} \times 0.5 \text{ m} \times 5 \text{ m}. \\ &= 1.25 \text{ cum} \end{aligned}$$

Since this trench gets filled twice in a day,

$$\text{Effective capacity of the trench} = 1.25 \text{ cum} \times 2 = 2.50 \text{ cum}$$

$$\begin{aligned}
 \text{Thus, the number of contour trenches} &= \frac{\text{Volume of runoff to be captured}}{\text{volume of each trench}} \\
 &= \frac{7,500}{2.50} \\
 &= 3,000 \text{ trenches}
 \end{aligned}$$

Step 3 ■ Finding the Length of Contour Trenches

We know that each trench is 5m. long. We also know that the space between each trench in a row is 2.50m. Thus, the total length (L) over which the trenches are spread:

$$= 3,000 \times (5 \text{ m} + 2.5 \text{ m}) = 22,500 \text{ m}$$

Step 4 ■ The distance between rows of contour trenches

The distance **d** between two successive rows of contour trenches is:

$$d = \frac{A}{L} = \frac{2,50,000}{22,500} = 11.11 \text{ m}$$

Step 5 ■ The number of rows of contour trenches (N)

In order to decide the number of rows of contour trenches (N) required, we divide the length of the longest section of the ridge area (L_r) by the distance between successive rows of contour trenches (d)

$$N = \frac{2500}{11.11} = 225$$

Solution to Example 2 The answers to numerical 2 for planning staggered contour trenches in 25 hectares in Indore are:

$$\text{Quantum of runoff} = 7,500 \text{ cum}$$

$$\text{Number of the Contour Trenches required} = 3,000$$

$$\text{Number of rows of contour trenches} = 225$$

$$\text{Distance between rows of contour trenches in a hectare} = 11.11 \text{ m}$$

7.9 Contour Trenches: DON'Ts

- ✘ Do not make trenches on slopes higher than 25%. Instead adopt vegetative measures
- ✘ Do not make trenches on slopes less than 10%. Instead construct contour bunds
- ✘ Do not excavate trenches where there is already dense vegetation
- ✘ Do not plant inside the trench
- ✘ Do not excavate if roots of a tree are encountered

- ✘ Do not excavate trenches across large streams or drainage lines
- ✘ Do not start the lay-out of trenches from the shorter section. Always begin from the longest section within the largest area of uniform slope

8 | Ridge Area Treatment: Earthen Contour Bunds



Contour bunds are a simple and low-cost method of checking the velocity of runoff in the ridge area of any watershed. A contour bund is a bund constructed along a contour line. A contour line is an imaginary line which joins together points of the same elevation. Making a bund along a line that is at the same level increases the chances of containing runoff for a longer period of time within the bund.

8.1 Objectives

1. Slowing down the velocity of runoff
2. Checking soil erosion
3. Improving local soil moisture profile

Contour bunds are constructed in the ridge area of a watershed. Rainwater which falls in this area, flows unchecked carrying with it eroded soil into the flatter portion of the watershed - the "valley". This silt gets deposited into reservoirs and ponds, reducing their life. Thus, any water harvesting work undertaken in the valley will become meaningless unless appropriate measures such as contour bunds and trenches are undertaken to control runoff and soil erosion in the ridge. Like contour trenches, bunds also collect

the rainwater that falls in the ridge area. This way the soil moisture profile in the area adjacent to the bund is improved. Along with the water, eroded fertile topsoil also gets deposited in the bund. It is, therefore, important to combine contour bunds with appropriate vegetative measures.

8.2 Location

1. **If the slope is more than 10% do not make contour bunds.** This is because on such steep slopes, the velocity of run-off will break these bunds.
2. **If the slope is less than 10% make contour bunds.** In a contour bund, water not only stops in the excavated portion but also against the bund. Therefore, here contour bunds must be constructed in place of contour trenches.

8.3 The Distance between Contour Bunds

The distance between two successive bunds depends on the volume and velocity of runoff they are expected to handle, which in turn depend on:

1. The quantum of rainfall: the greater the rainfall, the lesser the distance
2. The permeability of the soil: the more permeable the soil, the greater the distance
3. The slope of the land: the greater the slope, the lesser the distance

That is, as the volume and velocity of runoff increase due to any reason given above, the bunds should become more closely spaced. In several watershed programs, however, we have found that the vertical interval between bunds is fixed and the horizontal interval gets determined by the slope. Thus, for example, with a constant vertical interval of 1m, the contour bunds would be spaced at a horizontal interval of 10m on a 10% slope and 100m on a 1% slope. However, one must not follow this rule blindly without taking into account the catchment area that each contour bund has to handle. For example, on relatively higher slopes one may end up making too many bunds even though there is very little water that each bund needs to handle. And on low slopes, too few bunds are made which are unable to intercept most of the runoff, since each bund is expected to do much more than its fair share of work. In practice, one must fix the maximum and minimum horizontal interval between two successive contour trenches. For example, one can stipulate that:

1. *On high slopes, the bunds should be close to each other but never closer than 30 m.*
2. *On low slopes, the bunds should be far from each other but never farther than 60 m.*

8.4 Contour Bunds vs. Contour Trenches

Of these two methods of treatment of the ridge area, bunds are superior to trenches in one respect -- a rupee spent on contour bunds would create greater storage than a rupee spent on contour trenches. In a contour bund, water not only stops in the excavated portion but also against the bund. The storage capacity of contour bunds is higher than that of contour trenches for every meter (see Figure 8.1)

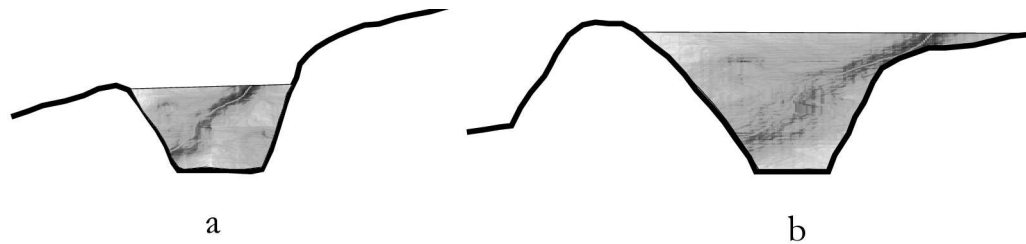

Figure 8.1: (a) In a contour trench water fills up only in the trench, but (b) in a contour bund, apart from the trench, the water stops by the bund wall too

However, bunds are inferior to contour trenches with respect to safety and maintenance operations. Bunds always face the danger of being breached by overtopping. Also, bunds can get eroded by rain and by being frequently trampled upon by animals. So, they require more maintenance operations. The danger of overtopping makes bunds inadvisable in regions with high slopes, where an intense burst of rainfall can cause high volume runoff which can overtop bunds. Where there are a series of bunds on a slope, the breach in one bund can cause several bunds below to be breached. In such conditions contour trenches are superior to contour bunds.

8.5 Design

Situation 1: In Relatively Permeable Soils

1. **Height:** 60 cm (see Figure 8.2)
2. **Settlement Allowance:** 20-25%
3. **Thus, height of bund at time of construction:** $60 \times 1.25 = 75$ cm. In gravelly soils, the settlement allowance can be lowered to 10%
4. **Top Width:** 20-30 cm
5. **Upstream Slope:** 1:1
6. **Downstream Slope:** 1:1.5. In gravelly soils, both upstream and downstream slopes can be kept at 0.75:1
7. **Exit:** On relatively flat permeable ridge area, an exit need not be given. However, in sloping lands, if exit is not provide, bunds might break. Rapidly flowing water

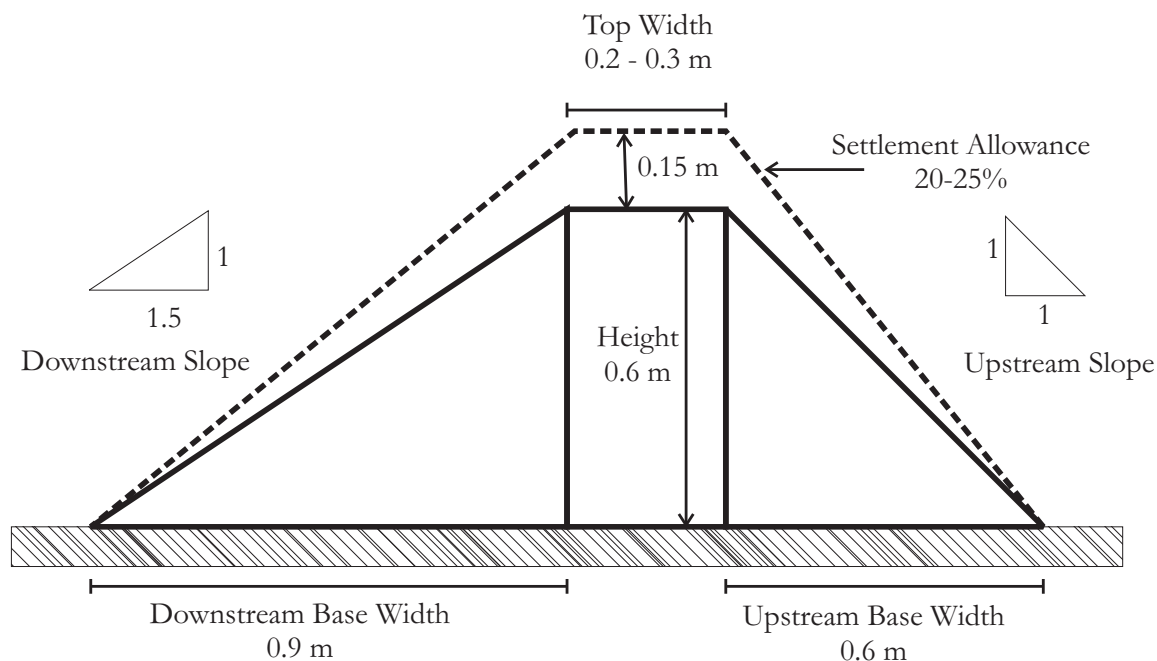

Figure 8.2: Cross-section of bund in permeable soils

may overtop the bund or slowly erode it. Therefore, provision of an exit becomes imperative. For purpose of water storage, the exit should be placed slightly above ground level. The water will stop at the bund for a short time and then flow out of the exit. In such cases, however, it is extremely important to strengthen those sections of the bund which are adjacent to the exit.

8. **Soil Excavation:** Soil should never be excavated continuously because this will cause the formation of channels, which will erode soil and carry out water. Instead, several discontinuous trenches should be made in which soil and water can collect. The width of this trench should be 1 m. Where excavation is discontinued, a small *tooth* should be constructed at 90 degrees or perpendicular from the bund (Figure 8.3). This tooth should be about 2 m. long and should have a maximum height of 30 cm. If stones are available, this tooth should be made entirely of stones. Otherwise, do not forget to provide a stone exit in teeth made of mud. In this way, there will be a series of bund and teeth, which will act as repositories of water and prevent soil erosion. If the slopes are low to moderate, the excavation should be done on the upstream side of the bund. If they are high and the soil depth exceeds 0.5 m., the bund can be constructed with mud excavated from the downstream side of the bund. The difference is that while excavation upstream would increase the slope of the land near the bund, excavation downstream would not.

9. **Berm:** There should be a distance of at least 30cm between the edge of the

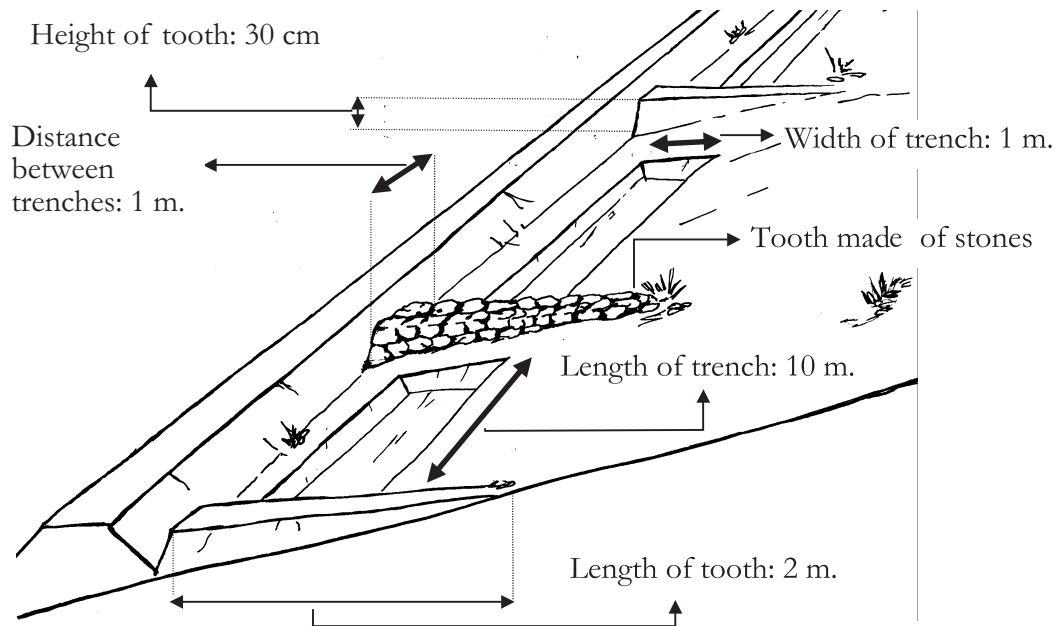

Figure 8.3: Excavation for construction of contour bunds should not be continuous. *Teeth* should be made at regular intervals perpendicular from the bund

excavated portion and the beginning of the bund. This gap between the bund and mud is called the *berm*. This prevents mud from sliding back into the excavated portion.

10. **Bund Protection with Plantation:** Wherever possible, contour bunds must be protected against erosion by planting grass on the bunds. Grass species such as *Cenchrus ciliaris*, *Stylosanthes hamata*, Deenanath (*Pennisetum purpureum*) etc. could be used for bund protection.

Situation 2: In Relatively Impermeable Soils

1. **Height:** 50 cm (see Figure 8.4). In impermeable soils, water takes a longer time to percolate below the ground. Therefore, there is always a danger of it overtopping the bund and breaching it. Thus, an argument can be made that bunds in such soils should be higher. However, in black clayey soils, this may create waterlogging and may also endanger the bund. In order to get around this dilemma, the bunds should be kept at a lower height, but in order to avoid waterlogging, an exit should be provided. In black, clayey soils, provision of such an exit is a must. In addition, the distance between bunds should be reduced to 20-50m so that unnecessary pressure is not created on any one bund.
2. **Berm:** There should be a distance of at least 30cm between the edge of the excavated portion and the beginning of the bund. This gap between the bund and mud is called the *berm*. This stops mud from sliding back into the excavated

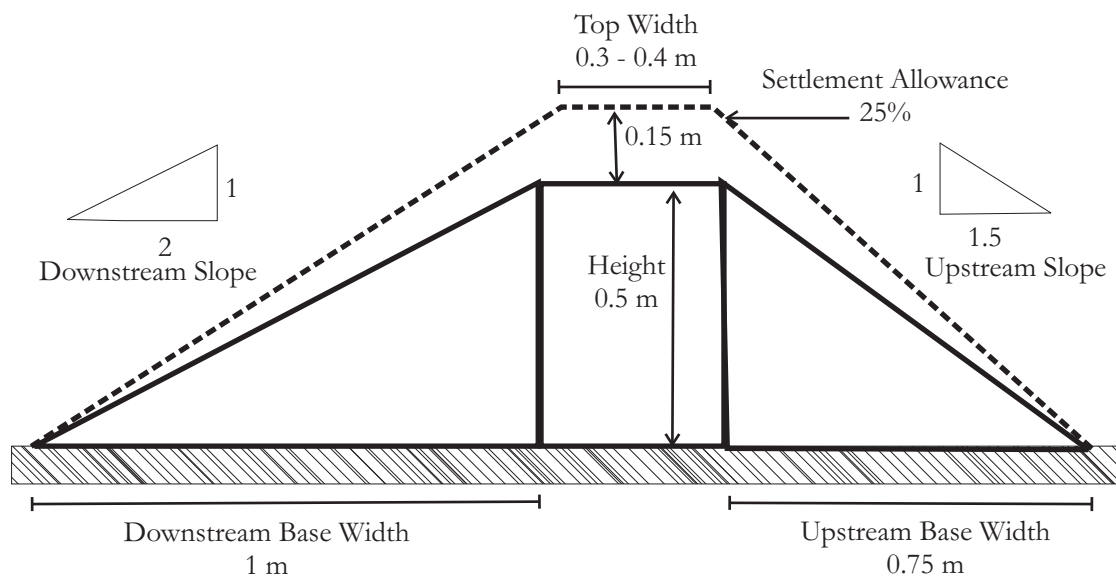

Figure 8.4: Cross-section of contour bund in impermeable soil

portion.

3. **Settlement Allowance:** The fine particles of clay have a natural tendency to settle. Also, such soils are found as clods. Depending upon the shape of the clods, it is important to give a settlement allowance of at least 25%. Clods of earth should be broken down, since the bigger the clods, the greater are the chances of the bund subsiding. The clods should be broken when they are dry. (Figure 8.4)
4. **Top Width:** 30-40 cm. The width of bunds made of clayey soils has to be greater because when the clay dries up, it cracks. Moreover, on such bunds it is very important to plant grass etc. whose roots stabilise the bunds. (Figure 8.4)
5. **Upstream Slope:** 1:1.5
6. **Downstream Slope:** 1:2 – Since clayey soils have a greater tendency to settle, bunds made from them should have lower slopes than those made on permeable soils. In particular, special care has to be taken to prevent water from seeping through the cracks in the bund and emerging across on the other side. After some time, the water starts forming wide channels downstream of the bund. To prevent this, the **downstream slope of the bund must be lower than its upstream slope**. Its base width can be kept at 2.5 m. This will prevent the seepage of water through the bund since it will be difficult for the water to seep through a broad bund.
7. **Bund Protection with Plantation:** Wherever possible, contour bunds must be protected against erosion by planting grass on the bunds. Grass species such as *Cenchrus ciliaris*, *Stylosanthes hamata*, Deenanath (*Pennisetum purpureum*) etc.

could be used for bund protection.

8. **Exit:** In black soils, if the slope permits, a channel should be dug upstream of the bund for the exit of water. As opposed to permeable soils, this excavation should be done continuously. The water flowing out of each section should be given a channel, which uses the natural slopes to conduct water into the main drainage line. Grass should be planted on such channels in order to prevent soil erosion. At every 10-20 m. interval, small bund should be constructed across these channels which should be filled with stones. This bund will prevent soil erosion, without obstructing the flow of water.

8.6 Contour Bunds: Step by Step

1. Measure the slope in different parts of the ridge area
2. Mark out areas with slope less than 10% for the lay-out of contour bunds
3. Begin with the longest section within this area. Suppose there is a section 80m long. If we begin laying out contour bunds of 40m successive intervals from this section, we will only be able to make 2 rows of bunds in the entire area. On the other hand, if we begin laying out contour bunds from another section which is 160m long, we will be able to make 4 rows of bunds. Thus, only when we start from the longest section will we be able to adequately cover the ridge area with contour bunds. Of course, we must also bear in mind that the interval between rows of bunds will narrow at the steeper slopes. Make sure that this interval does not become less than the minimum you have stipulated for your area.
4. Now, draw a straight line with wet lime from the top of the slope to the bottom of the slope
5. On this straight line, mark points at the decided interval between successive contour lines
6. Starting from each mark, demarcate the contour line
7. Make bunds along these contour lines
8. Depending on the specific conditions (such as thick vegetation, rocks etc.), leave gaps from place to place
9. Undertake plantation as appropriate

8.7 Planning Contour Bunds

The planning and designing of contour bunds involves answering two questions:

1. how much of the rainfall do we want to catch? and
2. what length of bunds should there be to catch this amount?

8.7.1 How much of the rainfall do we want to catch?

To answer this question we need to estimate how much of the rain that falls will flow and run-off (Q), after some has been soaked up by the soil, or stopped by vegetative cover. As explained in the chapter on basic concepts, the percentage of annual rain we seek to harvest in any structure depends on the size of the structure. In a small structure like a contour bund, it is best (most cost-effective) to assume that we are trying to harvest the maximum rain likely to be received **in a day**. As we know,

$$Q = C \times R \times A$$

where $C =$ runoff coefficient

$R =$ quantum of daily rainfall and,

$A =$ the area of the ridge from which the runoff is received

We must remember that we do not want to catch *all* the runoff in the contour bunds of the ridge area. Suppose we only want to stall 70% of the runoff (Q_1) then

$$Q_1 = Q \times 0.7 \text{ cum}$$

8.7.2 Length of bunds required

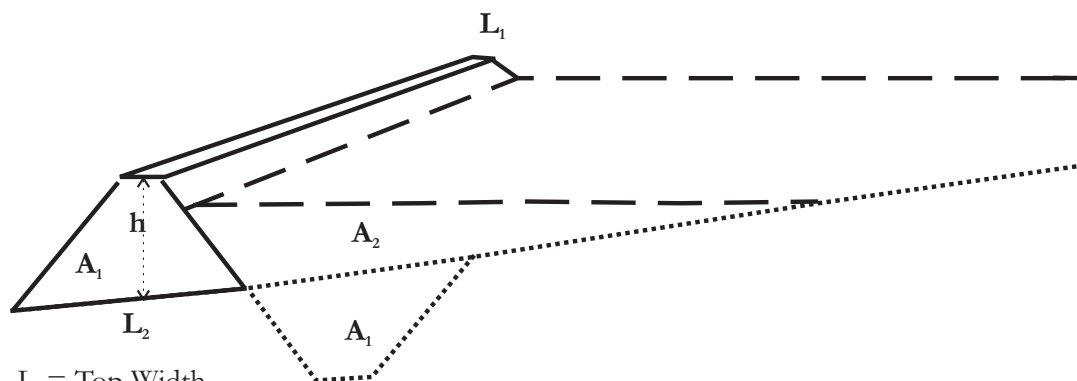

$L_1 =$ Top Width

$L_2 =$ Base Width

$A_1 =$ Cross Sectional Area of the Contour Bund

$A_2 =$ Cross Sectional Area of Water standing against the Bund

$h =$ Height of the bund

Figure 8.5: Cross-section of a contour bund

To arrive at the length of bunds, we divide the volume of run-off to be harvested by the cross-section area of the bund.

1. Determining the cross-section area of a contour bund: The cross-section area of a contour bund has an additional component. Apart from the dug-out portion (from which the mud is dug out to make the bund), there is also the portion where the water rises against the bund. Thus, to find out the cross-section area, A , of a contour bund, we need to find out:

- * Cross-section area of the contour bund: A_1 (see Figure 8.5)
- * Cross-section area of the water standing against the bund: A_2 (see Figure 8.5)

Therefore, the cross-section area of a contour bund is $A_b = A_1 + A_2$

How to calculate A_1 : The cross-section area of the dug-out portion A_1 is the same as the cross-section area of the bund itself.¹ By looking at the shape of the bund we can see that it approximates a trapezoid (see Figure 8.5). We know that (see also Figure 8.6):

Cross section area of a trapezoid = height \times average of the length of the parallel sides

$$= h \times \frac{(l_1 + l_2)}{2}$$

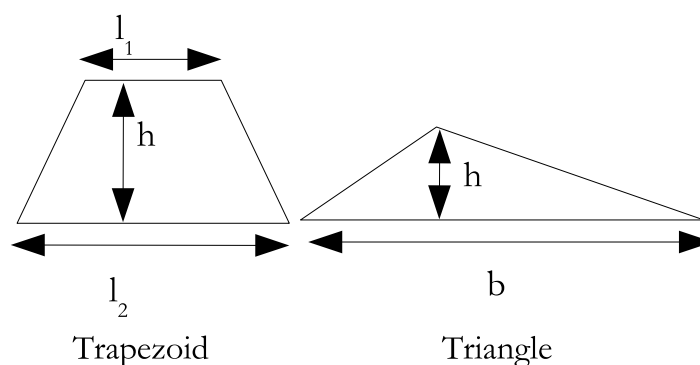

Figure 8.6: Cross section of a trapezoid and a triangle

How to calculate A_2 : This is the space behind a contour bund. This can be visualized in cross-section as a triangle. The formula for the area of a triangle (see Figure 8.6):

$$\begin{aligned} \text{Area of a triangle} &= \frac{1}{2} \times \text{base of the triangle} \times \text{height of the triangle} \\ &= \frac{1}{2} \times b \times h_1 \end{aligned}$$

where, $h_1 = h - \text{freeboard}$ (the height upto where water will fill up in front of the bund (since we have to provide an exit in a bund we cannot fill up the whole bund with water))

¹ This is not strictly correct as natural compaction is always greater than the human compaction to make the bund. For simplicity we ignore this.

How do we find out the base and height of the triangle here?

We already know the value of h , the height till where the water will rise against the bund. We can also measure the slope of the land here.

$$\text{We know that Slope } (s) = \frac{h}{b} \text{ or } b = \frac{h}{s}$$

3. Number of refills of a contour bund: We will also need to bear in mind that the bunds will fill up more than once in any spell of rainfall. The more permeable the soil in which the bunds are made, the more number of times will the bunds fill with water. For instance, in a black cotton soil or hard rock area, the number of times the bunds fill up will be lower than the number of times they fill up in highly permeable soils such as mooram or sandy soil. The number of refills will be higher in the early part of the season when soils are drier than in the later part of the monsoon when the soils are already relatively saturated. In practice, we assume that the number of refills (f) is somewhere between 1.5 and 3.

4. How long should bunds be? To calculate the total length of bunds required to halt 70 % of the run-off, we divide Q_1 (70% of the quantum of run-off) by the product of the cross-section area A_b and f the contour bund multiplied by the number of refills. Thus, length of contour bunds L can be shown thus:

$$L = \frac{Q_1}{(A_b \times f)} \text{ metres}$$

8.8 How to layout these bunds in the ridge area

Laying out bunds in the ridge area involves finding out the number of rows of bunds required and the distance between successive rows of bunds.

Distance between rows of contour bunds: We know A , the area where bunds are to be made. We have also determined the total length of the contour bunds (L) to be made. The distance d between two successive rows of contour bunds will be:

$$d = \frac{A}{L} \quad \text{where} \quad \begin{array}{l} A = \text{Area where the bunds have to be made} \\ L = \text{length of contour bund} \end{array}$$

In effect we have approximated the ridge area to be shaped as a rectangle. This is a practical thumb-rule which works reasonably well on the ground

The minimum distance between two rows of continuous bunds should be 30 meters and the maximum should be 60 meters. If after designing, the distance estimated is less or more than those given above one should bring the distance within these specified parameters.

The number of rows of contour bunds: As we explained in the section on design, we

begin layout of contour bunds from the longest section of the ridge area. In order to decide the number of rows of contour bunds (N) required, we divide the length of the longest section of the ridge area (L_r) by the distance between successive rows of contour bunds (d):

$$N = \frac{L_r}{d}$$

8.9 Learning by Doing: Planning Contour Bunds

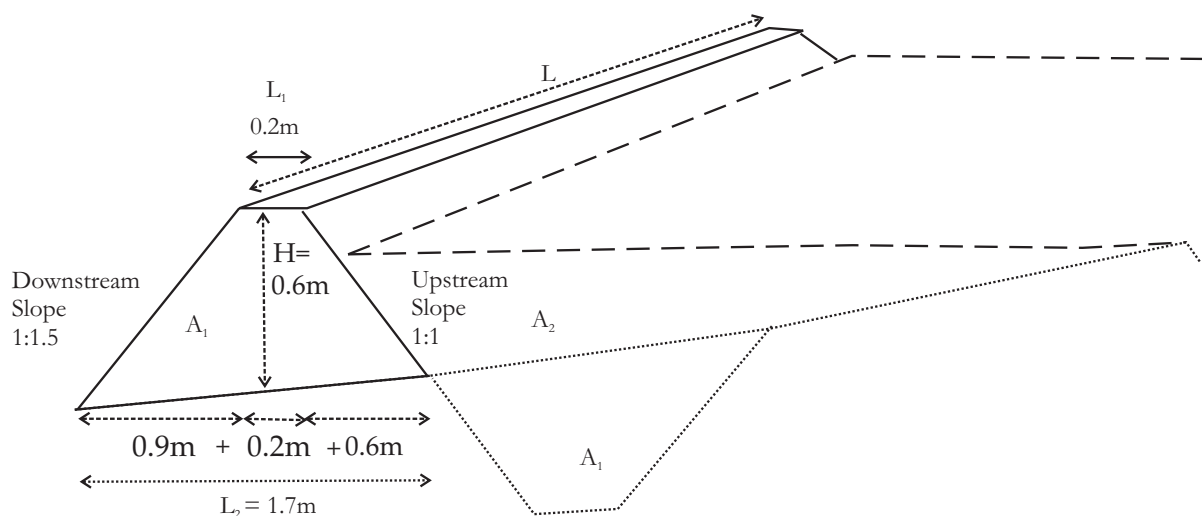

- L = Length of the Contour Bund
- L_1 = Top Width
- L_2 = Base Width
- A_1 = Cross Sectional Area of the Contour Bund
- A_2 = Cross Sectional Area of Water standing against the Bund
- h = Height of the bund

Figure 8.7: A numerical example

Example: Planning Contour Bunds

Design contour bunds in a 15 hectare area of Indore. The run-off co-efficient of this area is 0.6. The maximum likely rainfall in a day is 100mm; the slope is 5%, and the soil permeable. The height of the bund is .6m, the upstream slope is 1:1, the downstream slope is 1:1.5 and the top width of the bund is 0.2m. There are 1.5 refills in a day's rain. The longest section of the ridge area is 1500m.

Solution

Step 1 ■ Finding out the Quantum of Run-off to be harvested

As we know,

$$Q = C \times R \times A$$

where $C = \text{runoff coefficient}$

$R = \text{quantum of daily rainfall and,}$

$A = \text{the area of the ridge from which the runoff is received}$

$$\text{or } Q = \underbrace{0.6}_C \times \underbrace{0.1 \text{ m}}_R \times \underbrace{1,50,000 \text{ sqm}}_A = 9,000 \text{ cum}$$

We must remember that we do not want to catch *all* the runoff in the contour bunds of the ridge area. Suppose we only want to stall 90% of the runoff Q_1 , then:

$$\begin{aligned} Q_1 &= Q \times \frac{90}{100} \text{ cum} \\ &= 9,000 \text{ cum} \times 0.9 \\ &= 8,100 \text{ cum} \end{aligned}$$

Step 2 ■ Finding the Cross section of the Contour Bund

The cross-section area of a contour bund has an additional component. Apart from the dug-out portion (from which the mud is dug out to make the bund), there is also the portion where the water rises against the bund. Thus A_b is actually made up of:

- * Cross-section area of the contour bund: A_1 (see Figure 8.7)
- * Cross-section area of the water standing against the bund: A_2 (see Figure 8.7)

Therefore, the cross-section area of a contour bund is $A_b = A_1 + A_2$

How to calculate A_1 : The cross-section area of the dug-out portion A_1 is the same as the cross-section area of the bund itself. This approximates a trapezoid. We know that:

$$\begin{aligned} \text{Cross section area of a trapezoid} &= \text{height} \times \text{average of the length of the parallel sides} \\ &= h \times \frac{(l_1 + l_2)}{2} \end{aligned}$$

We know that $h = 0.6 \text{ m}$ and $l_1 = 0.2 \text{ m}$. We need to find the value l_2 , which is the base width

$$u/s \text{ slope} = 1 : 1$$

$$\therefore u/s \text{ side bottom width} = h \times 1$$

$$= 0.6 \times 1 = 0.6 \text{ m}$$

$$d/s \text{ slope} = 1 : 1.5$$

$$\therefore u/s \text{ side bottom width} = h \times 1.5$$

$$= 0.6 \times 1.5 = 0.9 \text{ m}$$

$$\text{Now } l_2 = \text{top width} + u/s \text{ side bottom width} + u/s \text{ side bottom width}$$

$$= 0.2 + 0.6 + 0.9 = 1.7 \text{ m}$$

$$\therefore l_2 = 1.7 \text{ m}$$

Cross section area of a trapezoid = height \times average of the length of the parallel sides

$$\begin{aligned} &= h \times \frac{(l_1 + l_2)}{2} \\ &= 0.6 \times \left[\frac{0.2 + 1.7}{2} \right] \\ &= 0.57 \text{ sqm} \end{aligned}$$

How to calculate A_2 : The space behind a contour bund can be visualized in cross-section as a triangle. The formula for the area of a triangle:

$$\text{Area of a triangle} = \frac{1}{2} \times \text{base of the triangle} \times \text{height of the triangle}$$

$$A_2 = \frac{1}{2} \times b \times h_1$$

$$\text{We know that } h_1 = 0.4 \text{ m}$$

since 0.2 m is the free board

$$\text{We also know the slope of the land } s = \frac{h_1}{b}$$

$$\text{or } b = \frac{h_1}{s}$$

$$\text{We also know the slope of the land } s = 5\% = \frac{5}{100} = 0.05$$

$$b = \frac{0.40}{0.05} = 8 \text{ m}$$

$$\therefore A_2 = \frac{1}{2} \times 8 \times 0.4 = 1.6 \text{ sqm}$$

Thus the total cross section area:

$$\begin{aligned} A_b &= A_1 + A_2 \\ &= 0.57 + 1.6 = 2.17 \text{ sqm} \end{aligned}$$

Step 3 ■ Finding out the Length of Bunds Required

To calculate the total length of bunds required to halt 90 % of the run-off, we divide Q_1 (90% of the quantum of run-off) by the cross-section area A_b of the contour bund multiplied by the number of refills, f .

$$\therefore \text{Length of contour bund, } L = \frac{Q_1}{A_b \times f} \text{ m}$$

$$L = \frac{8,100 \text{ cum}}{2.17 \text{ sqm} \times 1.5}$$

$$= 2,488 \text{ m}$$

We know A, the area where bunds are to be made (15 ha). We have also determined the total length of the contour bunds (L) to be made (2,488m). The distance between two successive rows of contour bunds d , will be:

$$\begin{aligned} \text{Distance between 2 rows of contour bunds } d &= \frac{A}{L} \text{ m} \\ &= \frac{15 \text{ ha}}{2,488 \text{ m}} \\ &= \frac{1,50,000 \text{ sqm}}{2,488 \text{ m}} \\ &= 60 \text{ m} \end{aligned}$$

Step 4 ■ Finding out Number of Rows of Bunds required

We begin layout of contour bunds from the longest section of the ridge area. In order to decide the number of rows of contour bunds (N) required, we divide the length of the longest section of the ridge area L_r by the distance between successive rows of contour bunds (d)

$$N = \frac{L_r}{d} = \frac{1,500}{60} = 25 \text{ rows}$$

Solution to Example 1

$$\text{Quantum of runoff} = 8,100 \text{ cum}$$

$$\text{Necessary length of contour bunds} = 2,488 \text{ m}$$

$$\text{Number of rows of contour bunds} = 25$$

$$\text{Spacing between 2 rows of bunds} = 60 \text{ m}$$

8.10 Contour Bunds: DOs and DONTs

- ✓ Always provide a berm of 30 cm.
- ✓ Always provide a settlement allowance.
- ✓ Exit must be provided in sloping land and in impermeable soils.
- ✓ In impermeable soils increase the cross section area of bunds.

- ✗ Do not start the lay-out of bunds from the shorter section. Always begin from the longest section within the largest area of uniform slope
- ✗ On high slopes do not make bunds closer than 30 m.
- ✗ On low slopes do not make bunds farther than 60 m.

- ✘ Do not make bunds on slopes higher than 10%. For slopes between 10% and 25%, contour bunds are more appropriate. For slopes above 25%, adopt vegetative measures
- ✘ Do not construct bunds where there is already dense vegetation
- ✘ Do not excavate if roots of a tree are encountered
- ✘ Do not excavate soil continuously in permeable soils.

Remember: How fast rain water flows in the field depends on:

1. the slope of the land
2. the permeability of the soil

That is, in highly sloping land and impermeable soil, water will flow more rapidly. In order to ensure safety and utility of the bund:

- ✓ Increase the downstream slope of the bund
- ✓ Decrease the distance between bunds
- ✓ Provide an exit in the bunds

9 | Drainage Line Treatment: - Loose Boulder Checks



Boulder checks or gully plugs are loose rock dams made on small drainage lines or seasonal streams which have a catchment area of less than 50 ha.

9.1 Objectives

The main aim of constructing loose boulder checks is to reduce the velocity of water flowing through the drainage line. By reducing the velocity of runoff, boulder checks help in:

1. Reducing soil erosion;
2. Trapping silt which slows the rate of siltation in water harvesting structures in the lower reaches of the watershed.
3. Creating a hydraulic head locally which enhances infiltration of surface runoff into the groundwater system; and
4. Increasing the duration of flow in the drainage line. Therefore, the capacity of the water harvesting structures created downstream on the drainage line is utilised

more fully as they get many more refills.

9.2 Location

Boulder checks should be made as a series on a drainage line, with each structure dividing the overall catchment of the drainage line into smaller sections.

1. The independent catchment of each boulder check should not be more than 1 to 2ha.
2. Boulder checks should not be made where the bed slope of the drainage line at that point is above 20% because the check will not be able to withstand the high velocity of water flow. However, on a drainage line with an overall high bed slope, loose boulder checks can be constructed in sections where the local bed slope is less than 20%.
3. Boulder checks should be made where boulders are available in large quantities in the requisite size.
4. A boulder check should be made where the embankments are well defined and stable, and high enough to accommodate peak flows even after the check has been made, thereby preventing water from rising over and cutting the banks. The height of the embankment at the location of the structure must at least equal the maximum depth of flow in the stream plus the design height of the structure in the central portion of the drainage line. This rule is applicable to all structures in which overtopping is permissible.
5. Even though storage is not a primary consideration in the case of loose boulder checks, enhanced water retention and groundwater recharge is a desirable objective. Hence, locating the structure in those sections in the drainage line where the upstream slope is flatter may be advantageous. The flatter the upstream slope, the more would be the storage per unit height of the structure.

9.3 Laying out Boulder Checks on a Stream

There will be a series of loose boulder checks on each drainage line. The minimum vertical interval between two successive checks on a drainage line should equal the height of the structure, so that the water temporarily stored in one check will reach the toe of the check upstream. Any interval below this limit would mean under utilization of the capacity of the downstream boulder check. What interval we keep above this limit would require a balance to be struck between cost considerations and volume of water to be stopped. Once this vertical interval is fixed, the horizontal interval between two successive checks would depend on the bed slope of the drainage line: for instance, with

a constant vertical interval of 1m, the boulder checks would be spaced at a horizontal interval of 20m on a 5% slope and 10m on a 10% slope. In general the relationship can be expressed as follows:

$$HI = \frac{VI}{\text{Slope \%}}$$

Where HI is the Horizontal Interval and VI the Vertical Interval. However, one must not follow this rule blindly without taking into account the catchment area that each boulder check has to handle. For example, on high slopes one may end up making too many checks even though there is very little water which each check needs to handle. In practice, one must fix the maximum and minimum horizontal interval between two successive loose boulder checks:

1. On high slopes, loose boulder checks should be spaced close but not closer than 10m;
2. As the slope decreases, boulder checks must be spaced farther, but not farther than 50m.

9.4 Learning by Doing

Example 1: How many boulder checks can we make?

For example, in the micro-watershed, if there is a stream 1500m long, with a slope of 10%, then how many 1m high loose boulder checks can be made?

Solution

Basically we have to divide up the length of the stream into portions that will be occupied by units of loose boulder checks and the water stored behind them. We know that:

$$\text{Slope } S = 10\%$$

$$\text{Length of the Stream } L = 1,500 \text{ m}$$

$$\text{Height of the Boulder Check } VI = 1 \text{ m}$$

How far will the water stored behind the boulder check go?

$$\begin{aligned} HI &= \frac{VI}{\text{Slope}} \times 100 \\ &= \frac{1}{10} \times 100 = 10 \text{ m} \end{aligned}$$

Also, the base of the boulder check itself will occupy 5m. Therefore the effective width of a boulder check, $w = 10 \text{ m} + 5 \text{ m} = 15 \text{ m}$

Solution to Example 1

$$\begin{aligned} \text{Number of Boulder Checks} &= \frac{\text{Length of stream, } L}{\text{Effective Width of 1 Boulder Check}} \\ &= \frac{1,500}{15} = 100 \text{ boulder checks} \end{aligned}$$

Similarly, loose boulder checks can be planned for every micro-watershed. After a comprehensive survey in the field with surveying equipment, we can arrive at the actual number of loose boulder checks required as compared to the number we had estimated. By measuring the width of the stream during this survey, we should categorise the different sizes of boulder checks required, which will enable us to know how many 8m long, or 10m long or 13m long boulder checks there will be.

9.5 Design

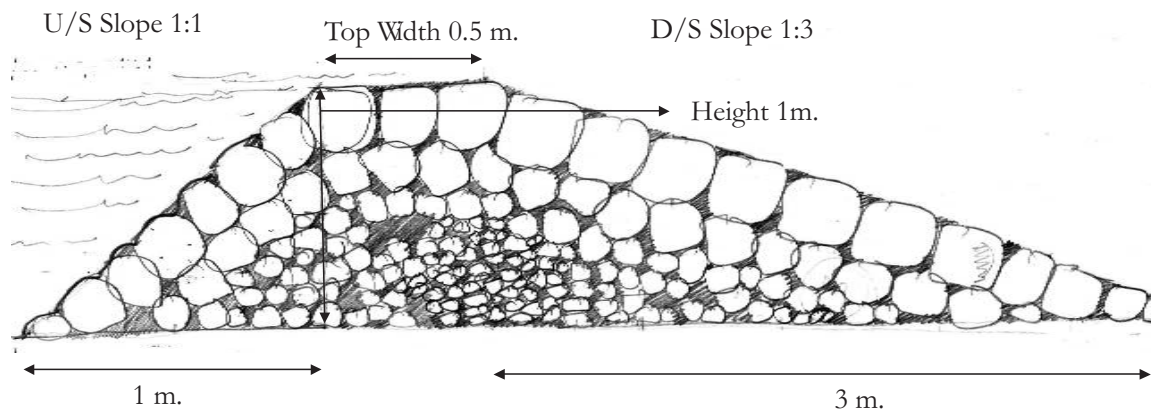

In the construction of a boulder check, bigger boulders are placed outside and smaller ones inside. On the outside, the biggest boulders are placed on the downstream side.

Figure 9.1: Cross section of a boulder check

Through years of experience in watershed development, the maximum height generally accepted for loose boulder checks is 1m. The design height of 1m means that the top of the check in the middle of the stream is 1m above ground level (see Figure 9.1). The top width of the boulder check is usually as 0.4m. As the material used in the check has a high angle of repose, the upstream slope of the check should be fixed at 1:1 in general, to be varied only in exceptional cases where the structure has to handle very high volume of runoff of high velocity. The downstream slope of the boulder check can vary from 1:2 to 1:4 depending on the volume and velocity of runoff. The higher the volume and velocity of runoff, the flatter the slope. Since the boulder check is composed of highly porous material it is not expected to hold water for a long period.

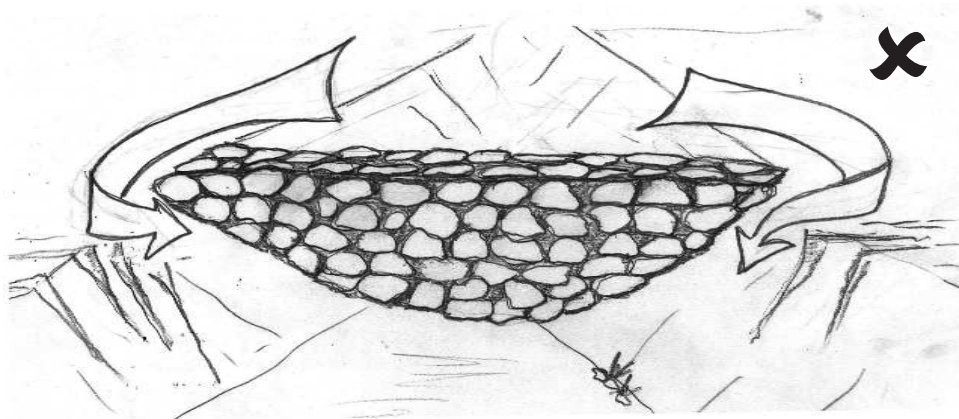

If no dip is given in a boulder check in the middle, and its sides are not embedded in the embankments, water will tend to cut through the embankments on either side, thus eroding them

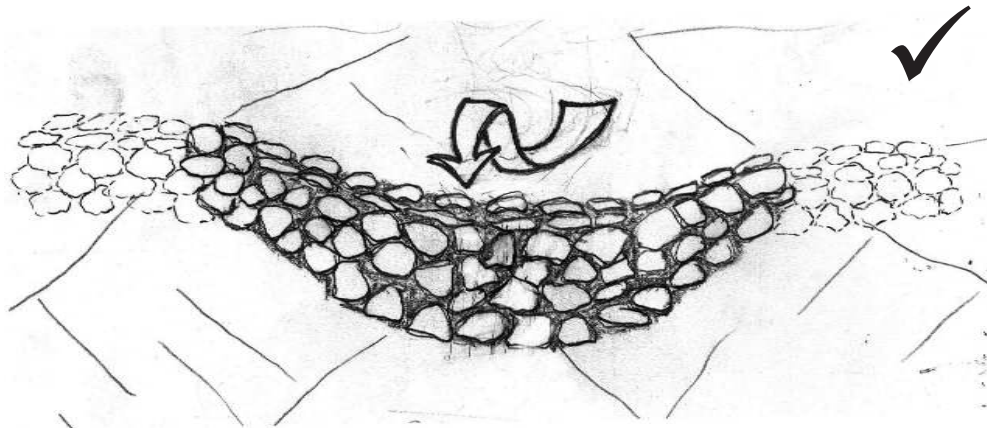

With a dip in the middle and sides embedded on either embankment, water flows over the dip safely without endangering the bund

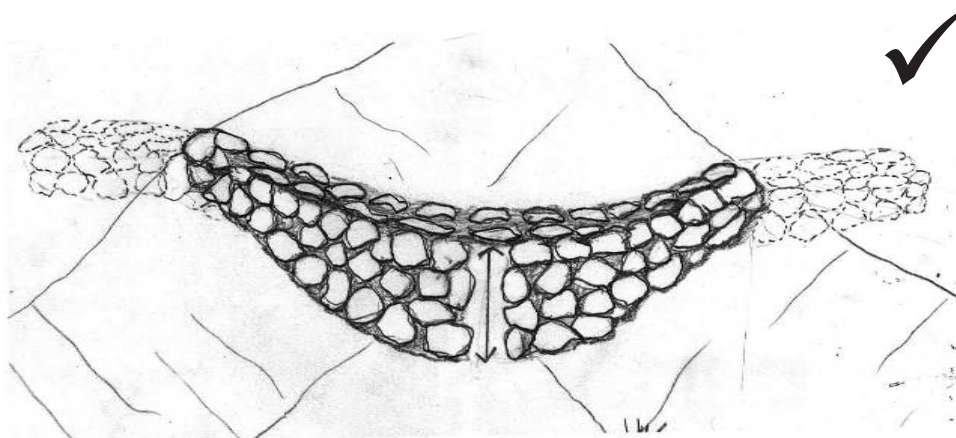

In order to create this dip, the height in the middle is kept less than that on the sides.

Figure 9.2: It is advisable to direct the maximum overflows through the middle of the structure

Hence, unlike in earthen structures, the downstream slope of the structure is not made to handle seepage problems. The downstream slope is given for two reasons:

1. to absorb the impact of water which enters the structure at a high velocity; and
2. to drain out water from the structure and make it trickle through at a non-scouring velocity.

If the top of the boulder check is level, water will flow over the check uniformly at all points. It is advisable, however, to direct the maximum overflows through the middle of the structure so that the water does not erode the embankments of the stream (see Figure 9.2). Therefore, there should be a dip in the middle of the structure and the top level of the structure should be higher towards the embankments on either side. The cross section area of the dip depends on the depth of peak channel flow: the higher the depth, the more is the cross-sectional area. The height of the boulder check on either side should not exceed the height of the embankment or 1.5m whichever is lower. The check should be embedded 0.5m into both the embankments. This is to prevent erosion of the embankment where the check joins it. If the bed of the drainage line has only boulders, the boulder check can be constructed without any foundation digging. If there is mud or sand in the bed, this must be excavated up to a maximum depth of 0.25m to secure an adequate foundation for the boulder check.

9.6 Determining the Height of Different Points of a Boulder Check

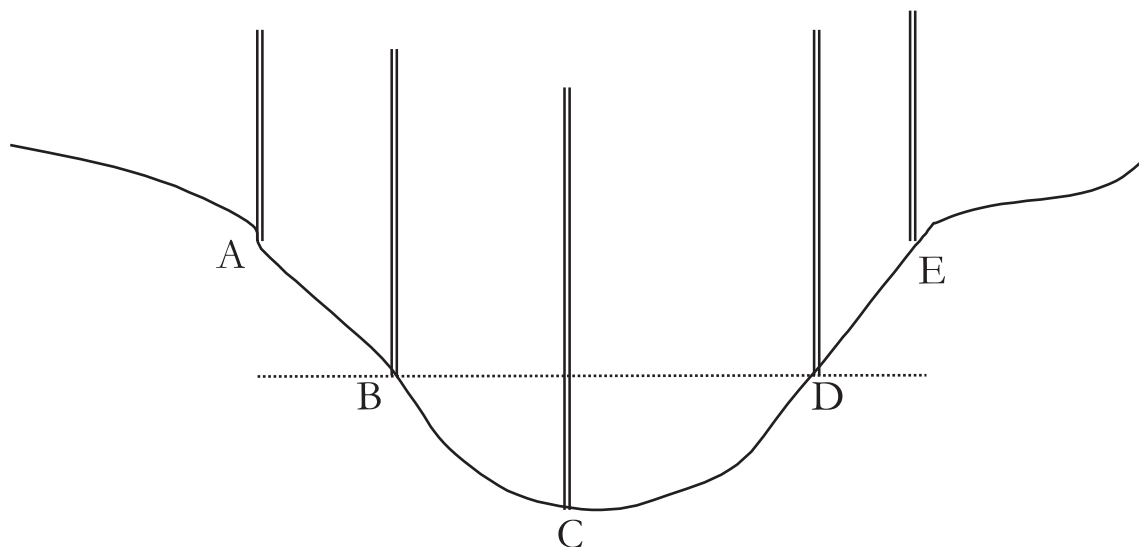

Figure 9.3: Cross section of the stream

Figure 9.3 shows the cross-section of the stream at a particular point. Let us now understand how to determine the exact height of a boulder check here at each point across the stream.

1. First of all place one scale of the pipe level at the lowest point **C**, on the bed of the stream. Slowly lift the other scale of the pipe level along the embankment.
2. When there is a difference of 1m (**VI**) between the readings on the two scales, mark this point as **A**, and note the reading on the scale.
3. Take another reading at a point **B** in between **A** and **C**.
4. Similarly mark points **D** and **E** on the other embankment and note their readings.
5. All these readings give us the RL of these points
6. Measuring the horizontal distance (**III**) between these points is simply done by a measuring tape.

Example 2: Measuring the heights of different points in a stream

Step 1 ■ Taking readings with the pipe level

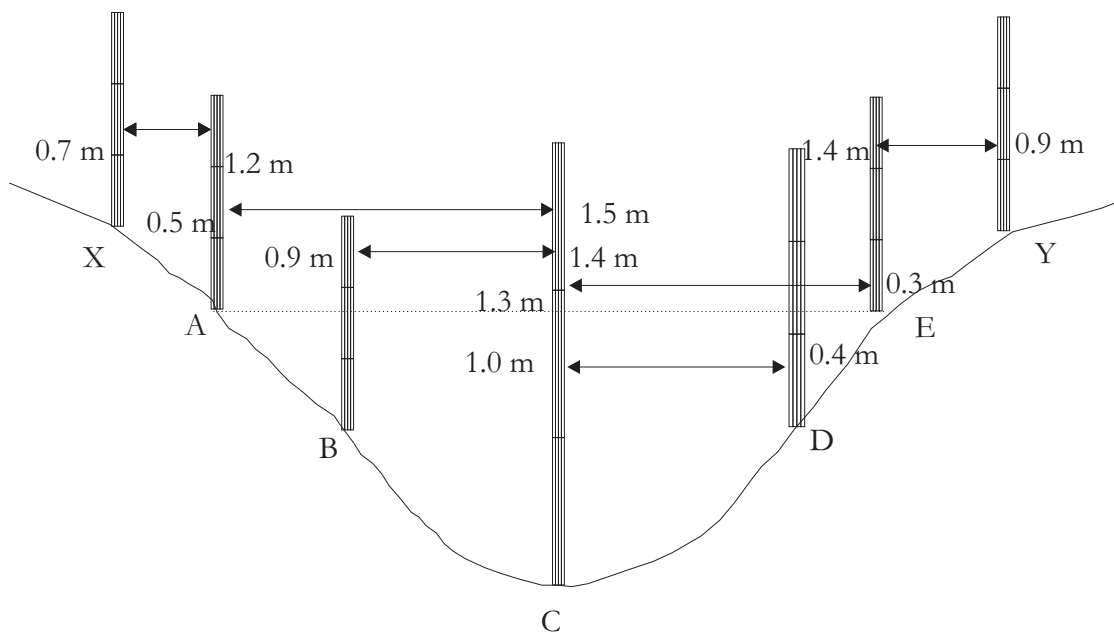

Figure 9.4: Readings taken from the pipe level

1. Read the measurement with one of the pipe level scales at point **C** and with the other scale read the measurement at **E**
2. Suppose the readings are 1.3m for **C** and 0.3m for **E** (see Figure 9.4)
3. Similarly measure the readings for **C** and **D** suppose that they are 1m and 0.4m

4. Similarly measure the readings for E and Y suppose that they are 1.4m and 0.9m
5. Similarly measure the readings for C and A suppose that they are 1.5m and 0.5m
6. Similarly measure the readings for C and B suppose that they are 1.4m and 0.9m
7. Similarly measure the readings for A and X suppose that they are 1.2m and 0.7m

Step 2 ■ Finding out the Elevation or RL of these points

1. Enter the data in the following table, where E is taken to be the benchmark at an RL of 100m.
2. Enter the data from points C to E in the columns named **Rise** and **Fall**. If C is lower than E then enter it in the **Fall** column, if C is higher than E then enter it in the **Rise** column.

We can see that C is 1m lower than E.

$$\therefore RL \text{ of } C = RL \text{ of } E - 1 = 100 - 1 \text{ m} = 99 \text{ m}$$

We can calculate the RL for all the points in the same way.

Point	Reading Rise (m)	Reading Fall (m)	Point	RL
E (BM)			E (BM)	100.0
C to E	-	1.0	C	99.0
D to C	0.6	-	D	99.6
Y to E	0.5	-	Y	100.5
A to C	1.0	-	A	100.0
B to C	0.5	-	B	99.5
X to A	0.5	-	X	100.5

Step 3 ■ Finding the exact design height of the boulder check

In order to find out the exact design height of the boulder check from the bed of the stream and the embankments, we just have to subtract the **RL** of each point from our benchmark point E at 100m to get the real height at different points of the boulder check from the bed of the stream to the embankments. Figure 9.5 plots these heights.

Point	Reading Rise (m)	Reading Fall (m)	Point	RL (m)	Height
E (BM)			E (BM)	100.0	0
C to E	-	1.0	C	99.0	1.0
D to C	0.6	-	D	99.6	0.4
Y to E	0.5	-	Y	100.5	- 0.5
A to C	1.0	-	A	100.0	0
B to C	0.5	-	B	99.5	0.5
X to A	0.5	-	X	100.5	- 0.5

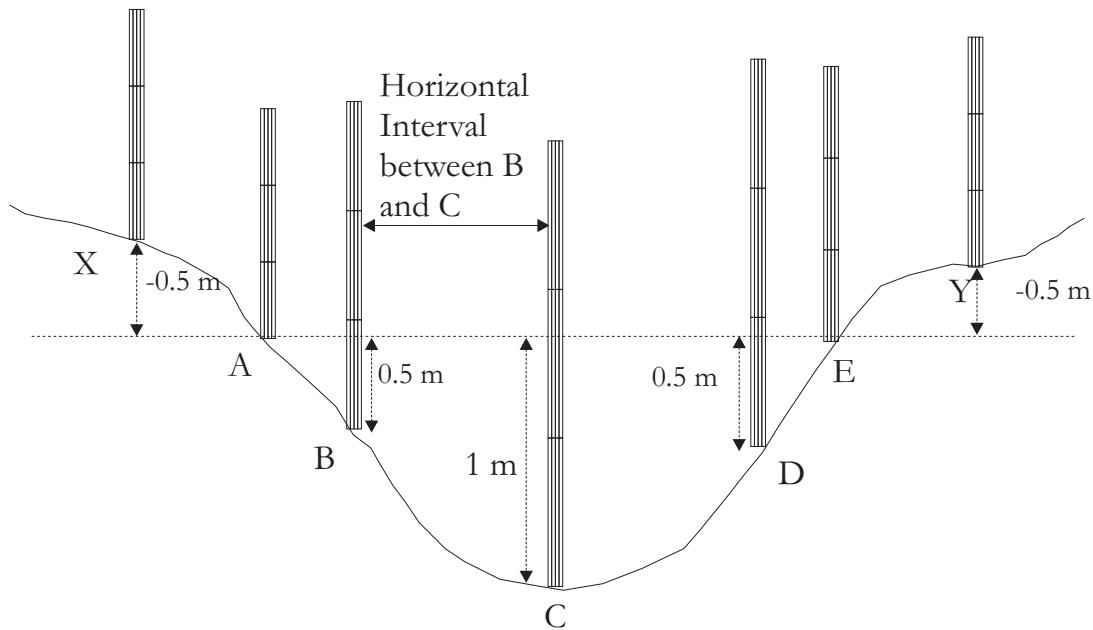

Figure 9.5: Height of boulder check at different points

9.7 Construction

Draw a line running through the centre of the proposed site for the boulder check till it reaches the points on either side which are 1.5m above the bed of the stream. Naturally, if the embankments are less than 1.5m high, this line will only reach till the top of the embankment. From this central line, mark 20cm on the upstream and downstream sides and draw parallel lines from embankment to embankment. These lines mark the boundaries of the crest. Suppose the required slope is 1:1 upstream and 1:3 downstream. From the centre of the upstream crest line, mark a point at a distance of 1m, along the perpendicular to this line. From the centre of the downstream crest line, mark a point at a distance of 3m, again along the perpendicular to this line. These points mark the upstream and downstream ends of the boulder check respectively. Draw lines connecting each of these points to the end of the crest lines on both sides. L

The trench in a boulder check is not usually dug in the bed of the stream. But if there is sand or mud at the base of the check, a foundation should be dug to a depth of 0.25m. Generally, digging the trench is only required for embedding the check into the embankment. Along the center line after it enters the embankments, dig a trench which is half a meter wide and half a meter deep. The trench must extend half a meter beyond the point where the crest of the check meets the embankment on both sides. Now the filling begins. The check should be raised in horizontal layers. The largest of the boulders must be placed on the outer sides especially on the downstream face (see Figure 9.6). The trenches cut into the embankments on either side of the check must

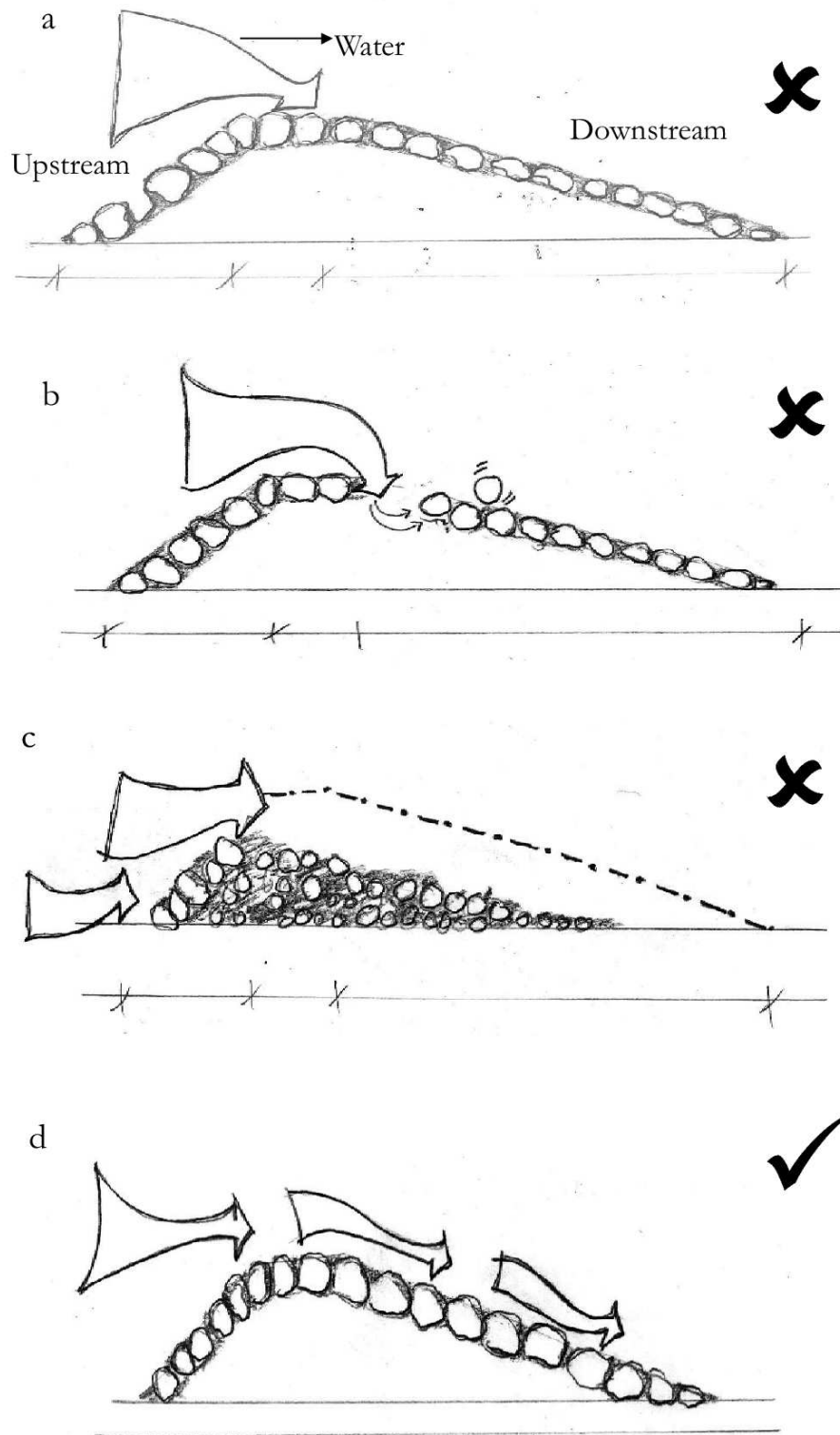

Figure 9.6: The largest boulders must be kept on the outer side as in (d) above. Otherwise, smaller boulders will be displaced by the force of water as in (a), (b) and (c) and the boulder check will break

also be filled with boulders. As successive layers are laid out, care must be taken that the downstream and upstream slopes are maintained as per design. When one reaches the crest of the check one must ensure that the top layer slopes down away from the embankments dipping towards the center of the check, thus providing a channel for the safe exit of excess runoff.

9.8 Material

1. The larger boulders must be placed on the downstream face of the check. The outermost edge of the downstream side must be dug up to a depth of 0.25m and the largest boulders available must be placed at the lower most edge of the check on the downstream and anchored to the ground.
2. Smaller stones can be used to fill up the interiors of the check.
3. The use of boulders with a diameter of less than 15cm (or weight less than 1 kg) must be avoided.
4. The use of angular stones gives greater stability to the check than the use of rounded boulders.
5. Shale, limestone, mudstone or any loosely cemented rock must not be used, because they disintegrate when in touch with water.

9.9 DOs and DON'Ts

- ✓ Locate the check only where the height of the stream embankment is greater than or equal to the sum of the peak depth of flow in the drainage line and design height of the structure.
- ✓ The top of the check should be lowest in the middle of the stream and highest at either embankment.
- ✓ The height of the check in the middle of the stream should be 1m above ground level.
- ✓ Upstream slope of the check should be 1:1 while the downstream slope can vary from 1:2 to 1:4.
- ✓ The bed of the stream at the base of the check should be cleared of mud/sand up to 0.25m depth.
- ✓ The top of the check should extend into either embankment by cutting a trench and filling it with boulders.
- ✓ Larger boulders should be placed on the outer portion of the check.
- ✓ The use of angular boulders should be preferred.
- ✗ No checks where the bed slope is above 20%

- ✘ No checks should be constructed where boulders are not adequately available within a radius of 50m.
- ✘ Do not use boulders dug up or picked up from the neighbourhood if such use would increase soil erosion in the area from where the boulders are picked up.
- ✘ Do not use boulders of diameter less than 0.15 m at any point which comes into contact with flowing water.

10 | Drainage Line Treatment: Gabion Structure



Gabion structures are rock and wire dams constructed across drainage lines with a catchment area of 50-500 ha. They are also constructed to reinforce highly erodable stream embankments.

10.1 Objectives

The main aim of constructing gabion structures is to reduce the velocity of water flowing through the drainage line. By reducing the velocity of runoff, gabion structures help in

1. Reduction in soil erosion;

2. Trapping silt, which reduces the rate of siltation in water harvesting structures in the lower reaches of the watershed.
3. Increasing recharge of groundwater and
4. Increasing the duration of flow in the drainage line. Therefore, the capacity of the water harvesting structures created downstream on the drainage line is utilised more fully as they get many more refills.

10.2 Location

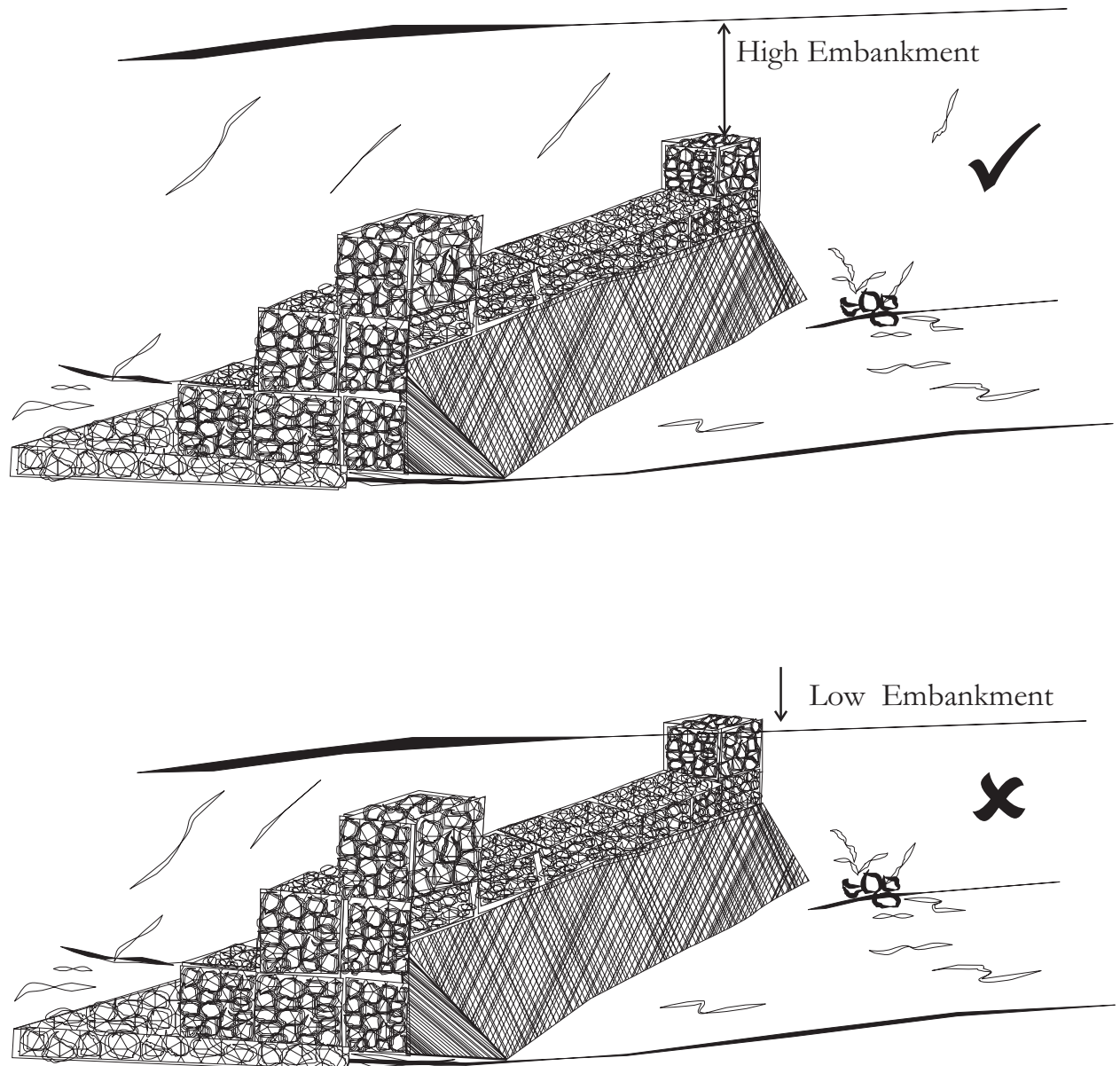

Figure 10.1: Gabion structures should be made where the embankments of the drainage line are high

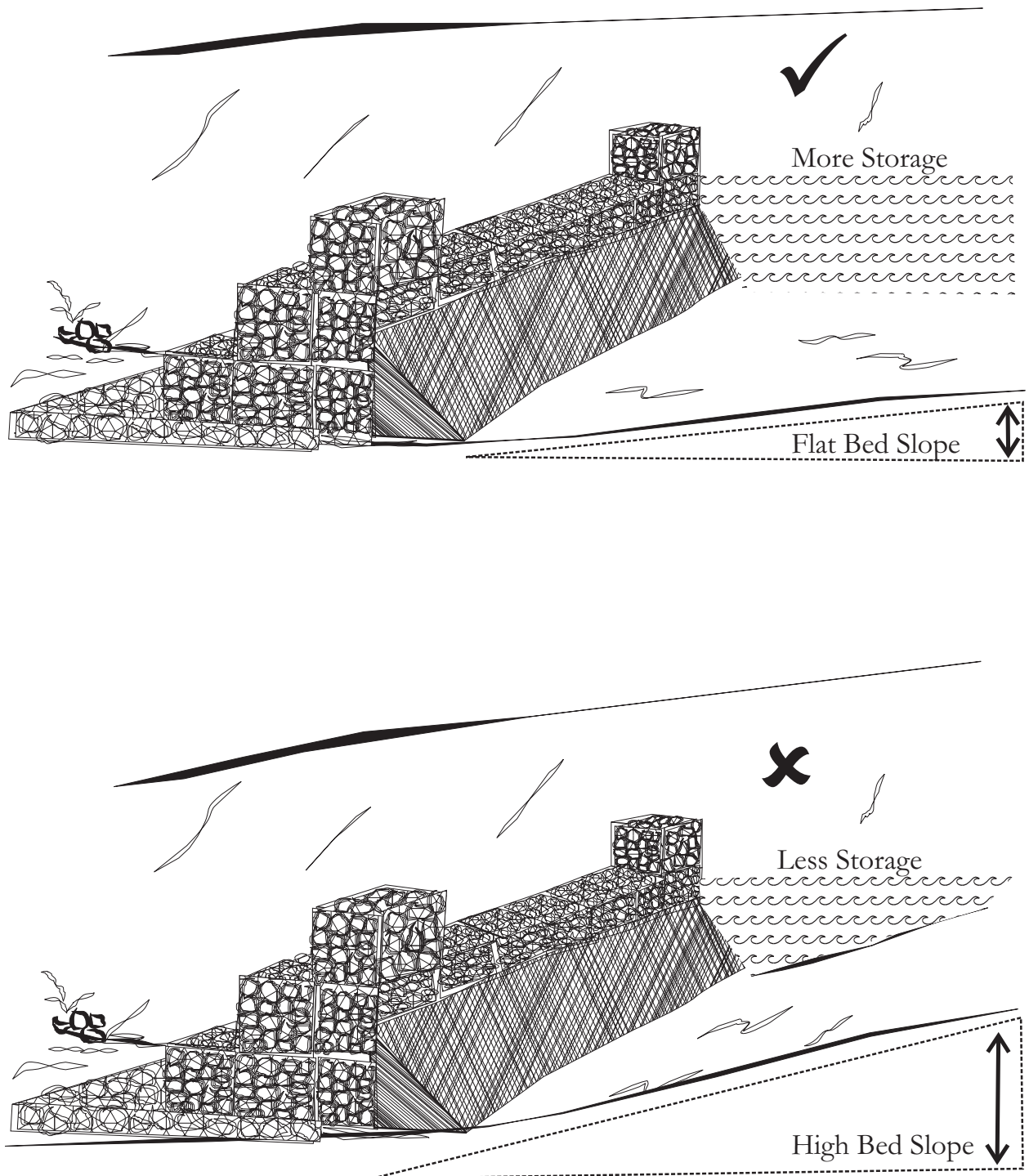

Figure 10.2: Gabion structures should be made where the bed slope of the drainage line is low

The minimum independent catchment area for a gabion structure is 5 ha. For a catchment area smaller than this even a loose boulder check may suffice. The precise location of a gabion structure depends on the following factors:

1. Stability of the embankments is the primary consideration. The less stable and more erodable the material on the embankments, the weaker the structure is likely to be. In such a situation, making the structure stronger would render it too expensive.
2. The height of side embankments from the bed of the stream must at least be equal to the sum of the depth of peak flow in the stream and the designed height of the structure (see Figure 10.1). For example, if the height of the embankments is 6m and the depth of peak flow is 4 metres, then the height of the gabion must not exceed 2 metres. Otherwise water will jump over the sides. Hence, observation of the peak flows is imperative before a gabion structure is planned.
3. For maximising storage in the structure, the bed slope of the upstream portion should be low (Figure 10.2). The flatter the upstream slope, the more will be the storage.
4. The material composing the bed of the drainage line upstream of the structure should not be completely impermeable, because what we want is temporary storage followed by groundwater recharge.

10.3 Design

There are two ways of reinforcing a loose boulder structure with wire mesh:

1. To make the structure as per the dimensions of the design and wrap it with wire mesh on all sides except the bottom. This wrap is partially anchored under the bottom.
2. To cage the boulders in rectangular boxes. The structure would be made up of several such boxes tied together. In such a structure the wire mesh not only provides a covering shell, it also gives horizontal and vertical reinforcements within the structure.

The second method is far superior to the first in terms of strength and it is economical in the use of boulders, although more wire mesh is used than in the first method. In this chapter, we concentrate on the second method.

10.4 Different Parts of the Gabion

The rectangular, box type gabion structure has the following sections (see Figure 10.3):

1. **Foundation:** The foundation should be dug upto a depth of 0.6 m across the bed of the drainage line for the entire length and width of the Headwall of the structure.

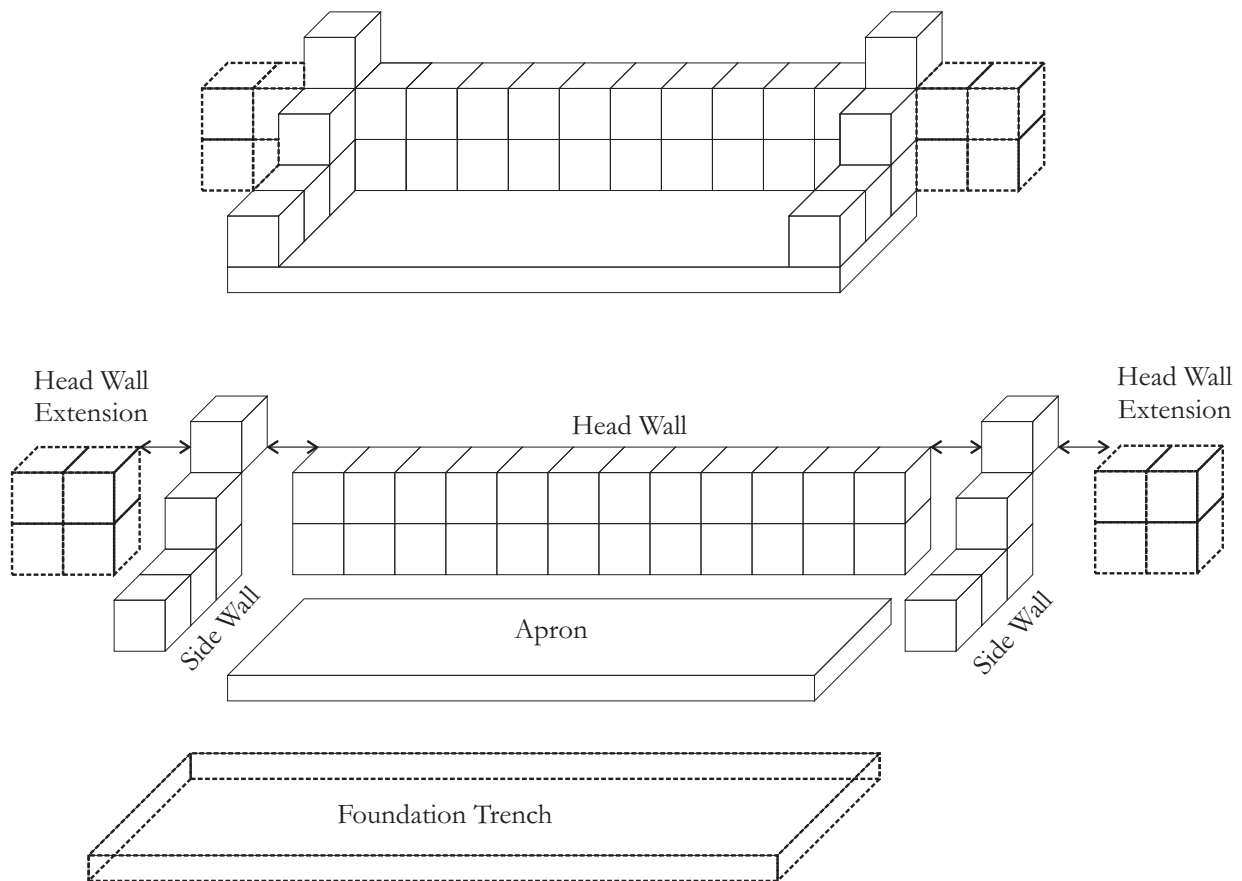

Figure 10.3: Constituent parts of the gabion

Where the stream bed has a thick layer of sand or silt the foundation will have to be dug deeper till a more stable layer is encountered. This foundation should be filled with boulders and the wire mesh should be anchored under the boulders.

2. **Headwall:** The headwall is built across the width of the stream from embankment to embankment. In most cases the top of the structure across the entire stream can be level. The entire length of the headwall serves as a spillway for the stream. Where it is required that most of the flows be directed towards the centre of the stream, that part of the headwall is lowered. For a height of up to 2m, the width of the headwall can be restricted to 1m. For heights beyond 2m, it is advisable to design it as a step-like structure, where the downstream face is constructed as a series of steps. For every 2m fall, a step should be provided of 1m width.
3. **Sidewalls:** Sidewalls are built to protect the embankments downstream from erosion by the stream spilling over the Headwall. On either end of the headwall, where the natural embankments begin, a block of the Sidewall is laid. The height of the sidewall above the top of the headwall is determined by the depth of peak flow in the stream. From here the Sidewall descends in a series of steps along the

embankments to the bed of the stream.

4. **Headwall Extension or Wing Walls:** The headwall is extended into both the embankments in order to anchor the structure and secure it against sagging on account of the pressure of water. From the same height as the top of the sidewall, the headwall extends into the embankments.
5. **Apron:** During peak discharge, the stream spills over the headwall and falls on the stream bed with considerable force that can cause severe erosion. Hence, some way has to be found to neutralise the force of falling water. For this we dig the stream-bed to a depth of 0.6m. for a distance of 3 to 6m from the Headwall downstream of the structure. This trench is filled with boulders and enclosed in a wire mesh which is anchored under the boulders. This is called an **apron**. The length of the apron depends upon the radius of the arc made by the water spilling over the headwall, which is in turn determined by the depth of peak flow in the naala. Therefore, the higher the depth of flow, the longer the apron should be.

10.5 Material

1. **Wire Mesh:** Good quality galvanised wire of gauge 12-14 (chain link) must be used for constructing gabion structures. Ready-made mesh with a single twist is commercially available. In these meshes the gap should not be more than 7.5cm x 7.5cm.
2. **Binding Wire:** The wire used for tying the wire mesh sections must be of the same strength as the wire used in the wire mesh. It could either be of the same gauge or of a thinner gauge plied and twisted together (see Figure 10.4).
3. **Boulders:** The minimum size of the boulders is dictated by the gap size in the wire mesh (see Figure 10.5). The boulders should be hard and should not deteriorate under water. Angular boulders are to be preferred to round boulders. Arrange smaller sized boulders in such a way that they fill the gap left by larger sized boulders. Besides rendering the structure less permeable, this minimises the damage to the structure on account of settling and sagging. There are two types of pressures operating on a gabion structure:
 - * static pressure of standing water; and
 - * the pressure of moving water. If small boulders are used in the structure, they could get shifted and dislocated on account of these pressures and the structure would tend to sag. The same problem will occur if the wire mesh is not drawn tight over the boulders.

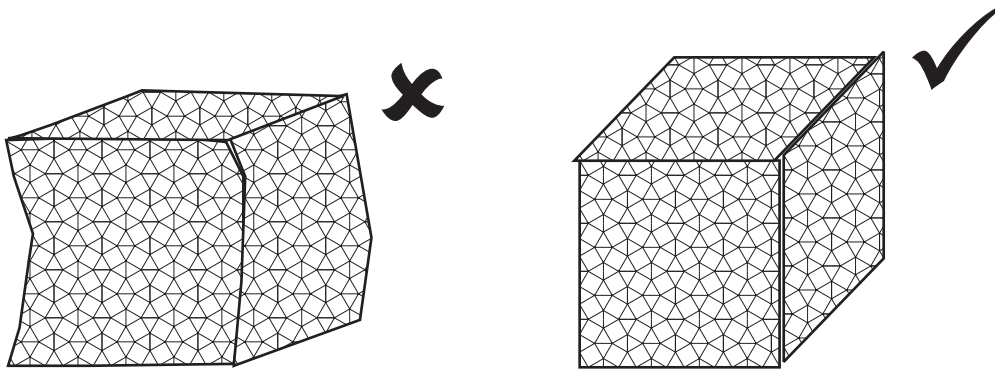

Wire boxes should not be loose. The wire should be pulled tight

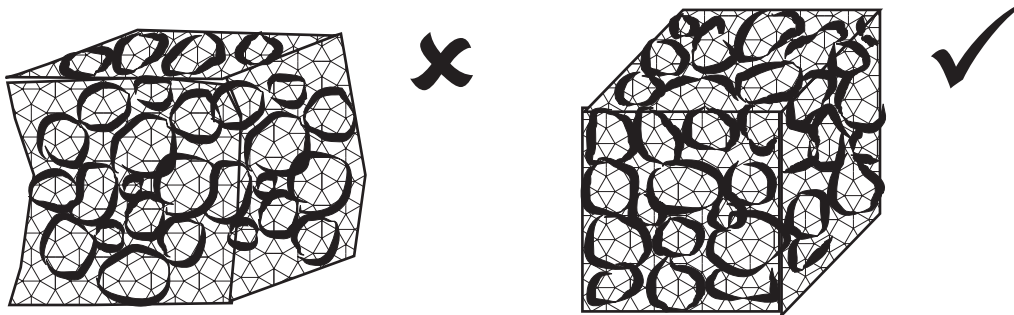

Stones inside the boxes should not be kept loosely. They should be packed tightly

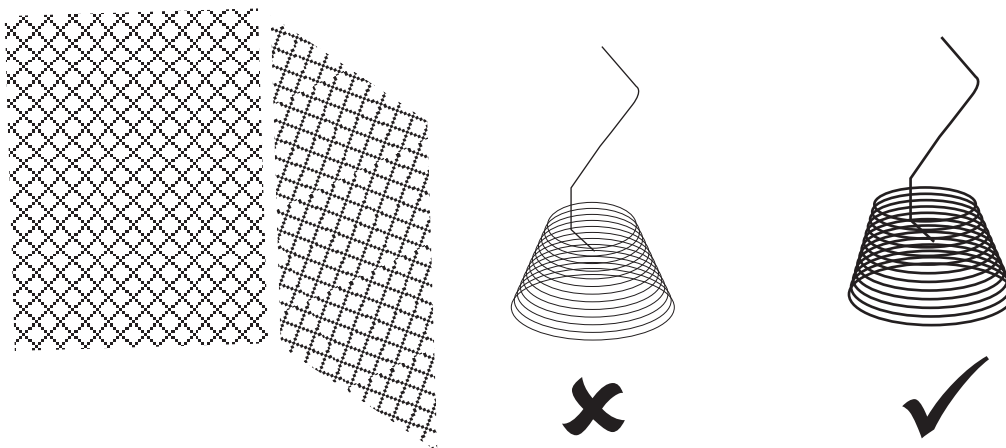

The shape of the wire mesh. Ensure that the wire used to tie up the boxes should be of the same thickness as that of the wire mesh

Figure 10.4: The wire mesh and boxes made out of it

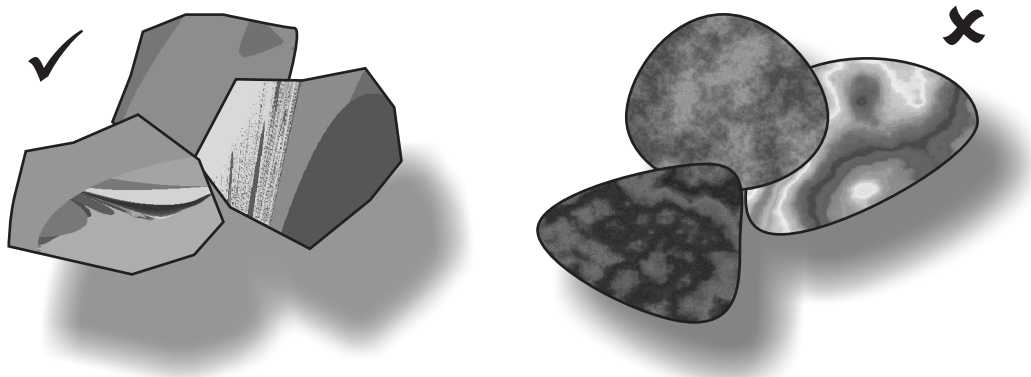

Use angular stones in a gabion rather than rounded ones

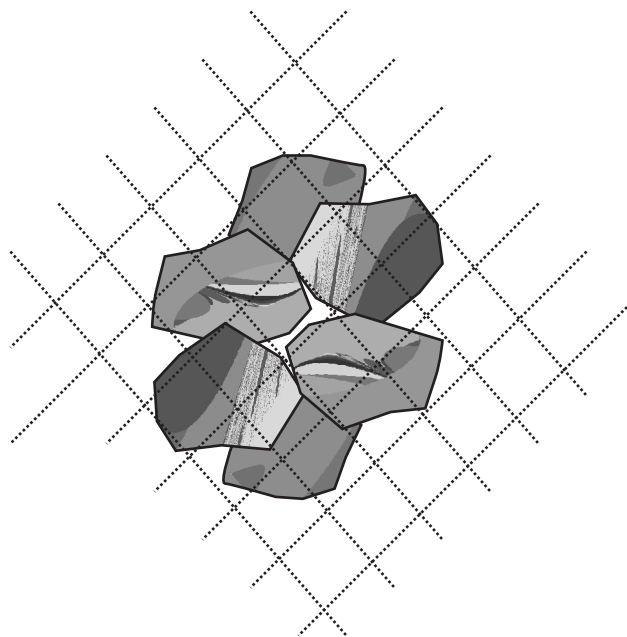

The smallest stone should be bigger than the hole in the wire mesh

Figure 10.5: How to select stones for the construction of a gabion

10.6 Construction

First of all boulders must be collected on the location site. For the Headwall, a 1m wide and 0.6m deep trench should be dug across the stream bed from embankment to embankment. Foundation of similar depth should also be dug for the area demarcated for the apron and the sidewalls. For the headwall extension the embankments are cut to the appropriate depth.

Before the foundation trench is filled, lengths of wiremesh are placed vertically at three places:

1. The upstream edge of the foundation;

2. Where the headwall ends and the apron begins; and
3. Against the downstream edge of the apron.

At all three places the wire mesh runs along the entire length of the structure (see Figure 10.6). Everywhere, 0.15m of the wire mesh is folded along the bed of the trench so that the mesh can be embedded under the boulders. After that the trench is filled with boulders upto ground level. Then, the wire mesh is laid over the entire surface and tied to the mesh which has been embedded under the boulders. The headwall as well as the sidewalls should be constructed as boxes of 1 to 2m length and 1m height.

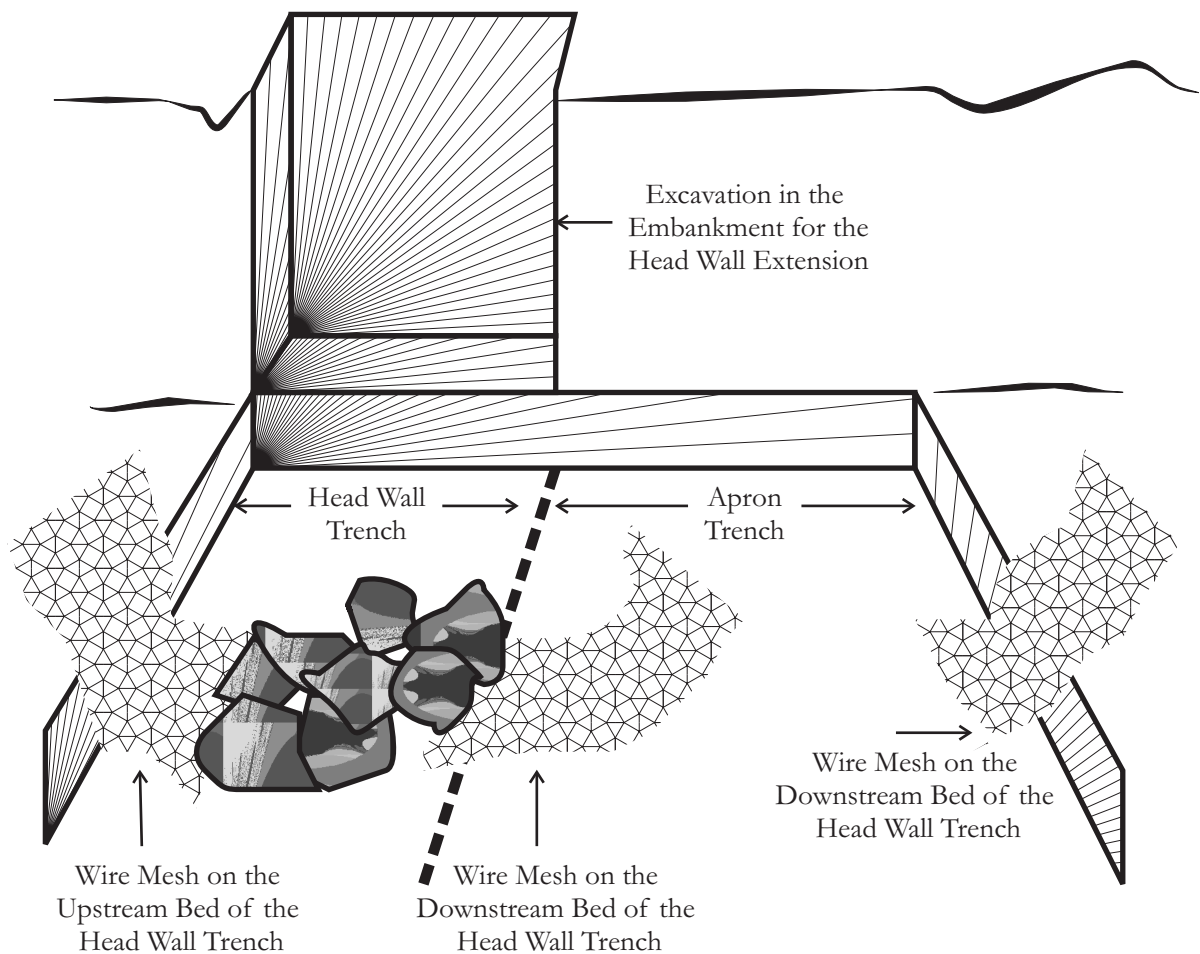

Figure 10.6: How to spread out the wire mesh

First the four vertical faces of these boxes are erected with wire mesh which is tied to the wire mesh in the section below as well as the section alongside. Then the boxes are filled with boulders and covered at the top with wire mesh. This wire mesh is tied to each of the vertical faces on all four sides. Such boxes are filled up in succession till the structure is complete.

To increase impermeability of the structure, a reverse filter should be constructed

on its upstream face (see Figure 10.7). This device is made by placing layers of small boulders, gravel, sand and mud against the structure. However, the order of placement of these materials is exactly the opposite of the arrangement in a normal filter. The boulders are placed closest to the structure, with gravel, sand and mud being placed successively away from it. The reason for the reverse order is that we want the finest material to come into contact with water first. Following the normal filter scheme would have allowed water to pass unchecked through the boulders and coarser material on the outer surface. One can even try to place used cement or fertilizer bags filled with fine sand against the structure in several layers.

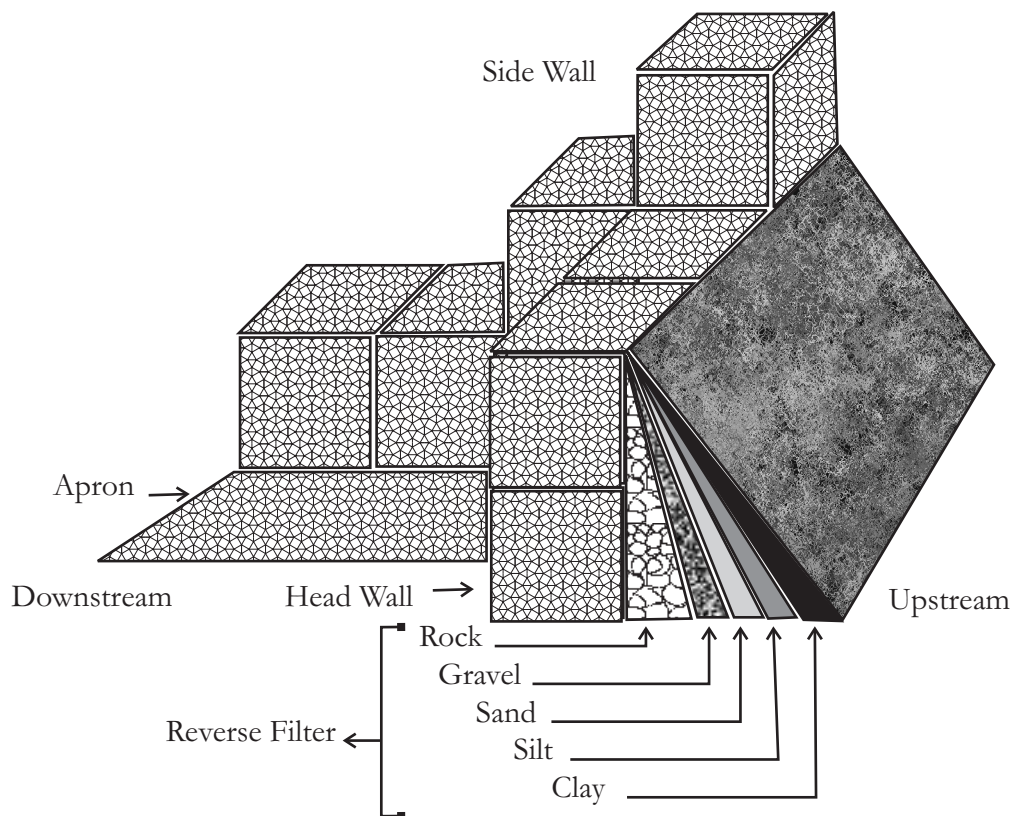

Figure 10.7: The gabion's reverse filter

10.7 DOs and DON'Ts

- ✘ Do not build a gabion structure where the embankment is highly erodable or is of insufficient height.
- ✘ Do not build a gabion structure at a point on the stream, below which the stream drops sharply.
- ✔ Locate the gabion structure where the naala width is relatively low.
- ✔ Locate the structure where the bed-slope of the naala upstream of the structure is

low.

- ✓ Care must be taken that the boulders are placed compactly against each other so that they do not slide or move under the impact of water.
- ✓ Smaller boulders must be placed in the interior part of these boxes while the larger ones must be placed on the outside.
- ✓ Even the smallest boulder should be bigger than the gap in the wire mesh.
- ✓ The wire mesh must be stretched taut so that there is no bulging or sagging.
- ✓ The wire used for tying the wire mesh sections must be of the same strength as the wire used in the wire mesh. It could either be of the same gauge or of a thinner gauge plied and twisted together.
- ✓ For height above 2m, the Headwall must be made as a series of steps sloping on the downstream side to impart stability to the structure.

10.8 Gabion Structure Along Embankments

These structures are built to cushion the impact of water, preventing it from eroding the banks. On high slopes surrounding roads or railway lines, such structures are built along contour lines to prevent landslides.

On stream embankments, these should be located in stretches prone to severe erosion. The length of the embankment to be strengthened has to be determined. Along this length the rectangular boxes have to be placed as a straight wall with a vertical face. The wall width could be a standard 1m while the length and height are both dependent on local conditions. The height of this wall should be at least 1m above peak flood levels of the stream. The upstream end of the gabion wall should be well embedded into the embankment so that the stream is not able to cut a path behind the structure. Care must be taken while raising the rectangular structure that the gap between the structure and the embankment is filled with rammed earth.

11 | Drainage Line Treatment: Underground Dykes



Where the catchment is large and the underground strata are favourable, sub-surface flows may continue throughout the year, long after surface flows cease to exist. Underground dykes are earthen dams that obstruct the flow of this sub-surface water and divert them to nearby wells and tubewells. Dykes do not submerge any land. Nor is the water stopped by them subject to evaporation.

Underground dykes are most suited to hard rock, black cotton soil areas such as the Deccan Traps. The area occupied by the Deccan Traps is about 320,000 sq.km.,

including Kutch, Saurashtra, Madhya Pradesh, Chhattisgarh and Maharashtra. They are found up to Belgaum in the south, Rajahmundry in the southeast and Amarkantak and Surguja in the east. In these areas, impermeable strata are often found at shallow depths below the surface and the soil required to fill up the dyke is relatively easily available.

11.1 Objectives

1. To impede the flow of sub-surface water and make it available in the watershed for a longer period (see Figure 11.1).

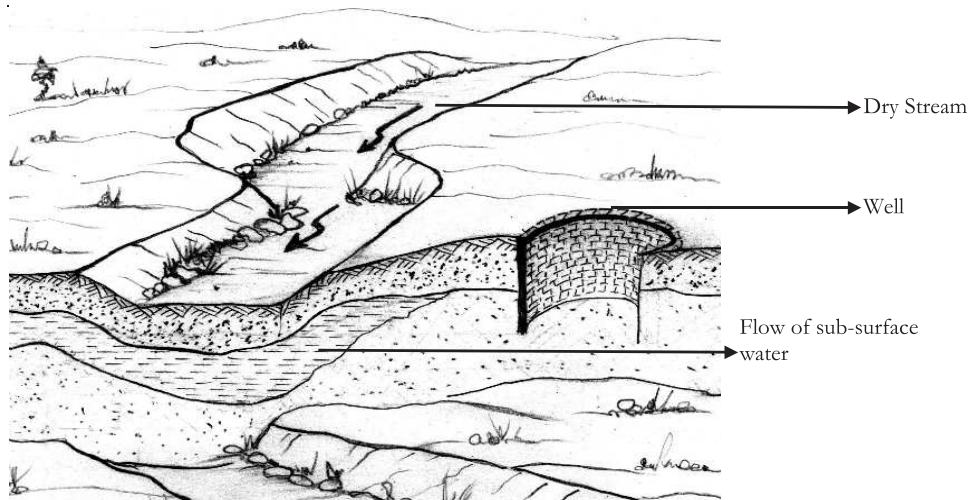

Sub-surface flows continue several months after surface flows cease

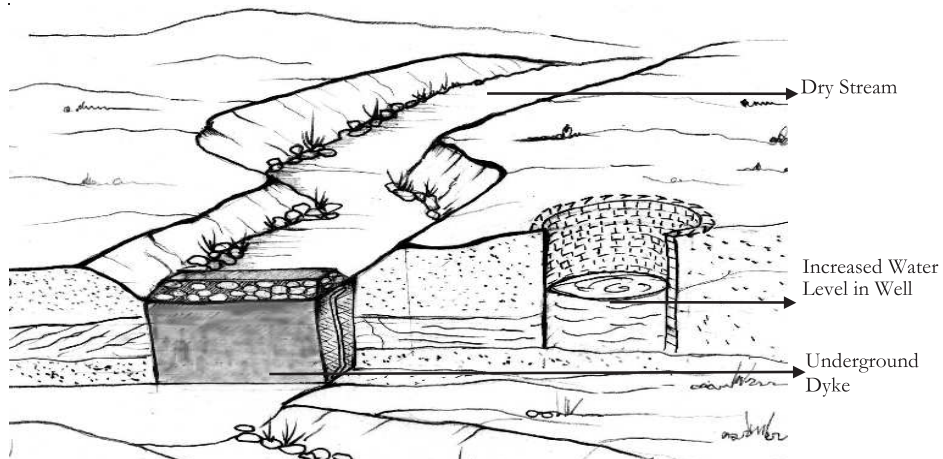

An underground dyke is a dam constructed on sub-surface flows. This stops the flow of groundwater and diverts it to nearby wells, thus increasing their water level

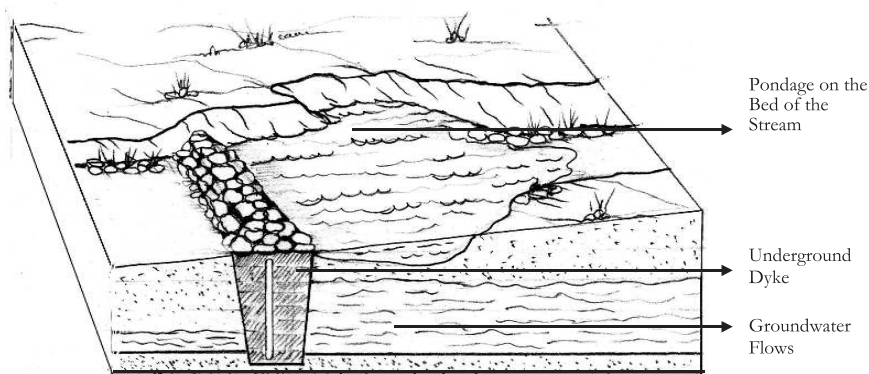

An underground dyke also creates pondage on the bed of the drainage line

Figure 11.1: Why dykes?

2. To increase the water level in wells by redirection of this sub-surface water to nearby wells and tubewells
3. To make surface flows in the drainage line available for a longer period.

11.2 Location

1. The drainage line on which a dyke is to be constructed must have **well defined, sturdy embankments**. Dykes should not be made on drainage lines which change their course year after year, or whose embankments are weak and subject to erosion.
2. Dykes must be constructed where **subs-surface flows occur at least until January**. This makes it possible to attempt to increase the water level in wells for the rabi crop. The longer the period for which sub-surface flows exist, the more beneficial dykes are.
3. The **location must have impermeable strata at a reasonable depth**. Otherwise, water stopped by the dyke will percolate below instead of spreading laterally. In order to construct a dyke, the drainage line bed is dug until impermeable strata are encountered. If, in order to reach such strata, we have to dig very deep, the cost of constructing the dyke will rise sharply and will outweigh the benefits from it.
4. **Dykes must be constructed in the vicinity of wells/handpumps**. This will increase the water level in wells/handpumps and augment water available for irrigation/drinking.
5. Dykes should not be built in those sections of the drainage line **where the bed slope of the drainage line is very high** because their impact will be limited. Due to the high slopes, the water stopped by the dyke will rapidly rejoin the drainage line downstream of the dyke.
6. How far the water stopped by the dyke will spread depends on two factors:
 - a) Are the strata under and adjoining the aquifer permeable?
 - b) Is the slope of the strata under and adjoining the aquifer high or low?
7. The dyke must always be constructed **perpendicular to the overall direction of flow in a drainage line**. Where there are several twists and turns in the drainage line, the dyke must be constructed perpendicular to the overall direction of flow of the entire drainage line.
8. If one of the objectives of dyke construction is to achieve pondage on the surface of the drainage line then the dyke should be constructed at a site where:
 - a) the slope of the drainage line upstream of the dyke is not too high and

- b) there are small depressions in the bed of the drainage line immediately upstream in which water can collect once it rises to the surface (Figure 11.1)

11.3 Construction

1. Choose an **appropriate site** on the basis of the considerations outlined above
2. On the bed of the drainage line, from one embankment to the other, **dig a trench whose top width is 1.25 metre**. Where one has to dig a little deep, the top width can be increased. The width of the **bottom of the trench should be 1 metre**.
3. Keep digging until **hard rock or an impermeable stratum is encountered**
4. Clayey soil should be piled up near the site. It should be watered and puddled. This puddled clay should be made into balls for filling up the trench. Fill up the trench with puddled clay balls, layer by layer. Each layer should be 15-30 cm thick so that it can be compacted properly
5. It is important to compact these clay balls so that they become impermeable and do not allow water to pass through. To achieve this compaction, people should get into the trench. These people should use their feet to trample the clay balls thrown into the trench.
6. Filling the trench with puddled clay balls should stop 30 cm below the bed of the drainage line. This last layer of 30 cm. should be filled up with sand, gravel and small boulders. In this way, the clay underneath can be prevented from being washed away by the flows in the drainage line.
7. There may be one problem in the digging and filling up of the trench - the constant influx of groundwater. Arrangements have to be made for the drainage of this water from the trench.
8. Especially in situations where the availability of clay is at a premium, a plastic sheet is also inserted into the trench. This makes the dyke more impermeable. The sheet can be inserted in two ways:
 - * First lower the sheet along one wall of the trench. When the sheet reaches the bottom of the trench, then pull it up along the other wall. In this way, the sheet will be placed in a U-shaped manner in the trench (Figure 11.2). Puddled clay balls should be piled up inside this lined trench in the same way as described above.
 - * In the second method, the plastic sheet is placed in the middle of the trench (Figure 11.2). The sheet should be tied to a rope and then lowered to the bottom of the trench. The rope should be pegged on each embankment. Puddled clay balls should be filled on both sides of the plastic sheet.

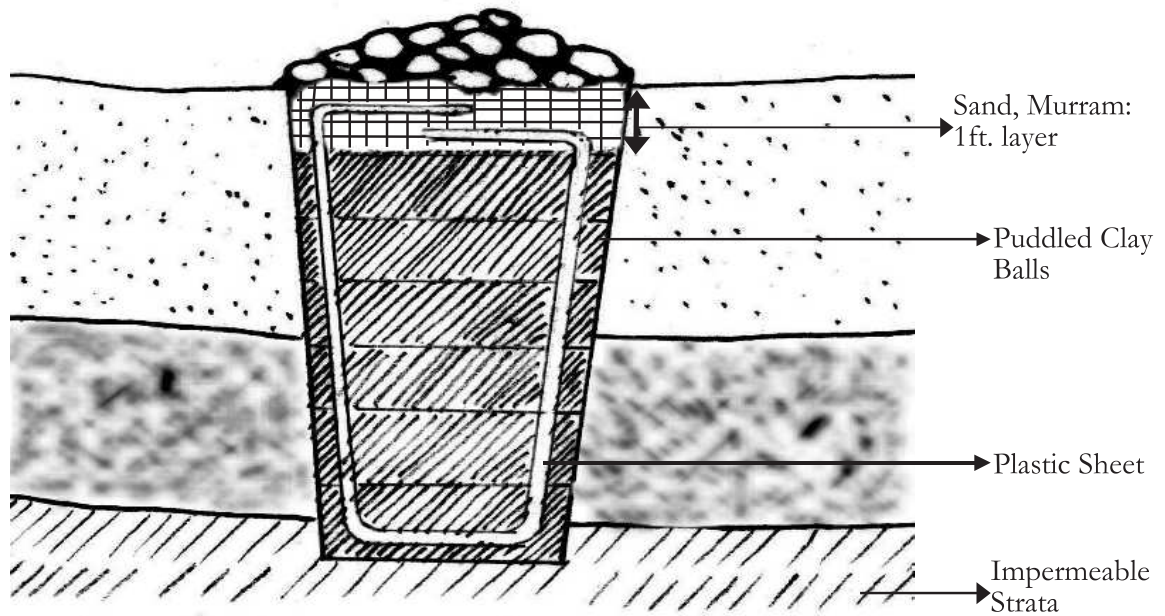

There are two ways in which the plastic sheet can be placed in the dyke. In the first method, the sheet is inserted in a "U" shape . . .

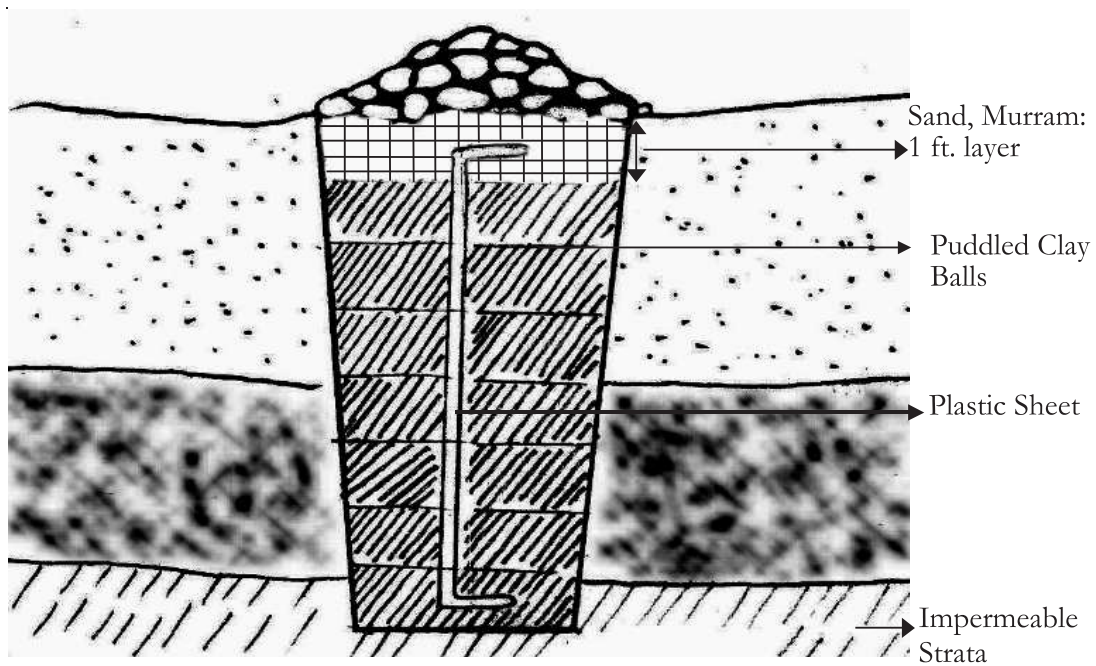

. . . in the second method the sheet is placed in the middle of the dyke

Figure 11.2: Two ways of spreading the plastic sheet inside the dyke

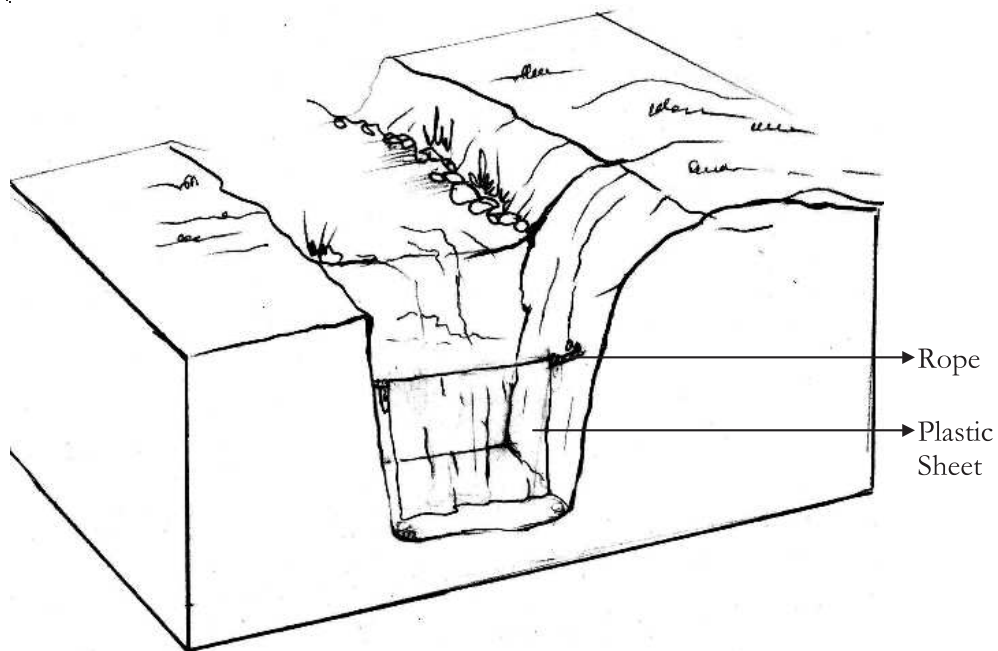

Where the trench has to be dug deep, the plastic sheet has to be rolled on a rope. At first, the rope has to be lowered half way down the trench and then tied . . .

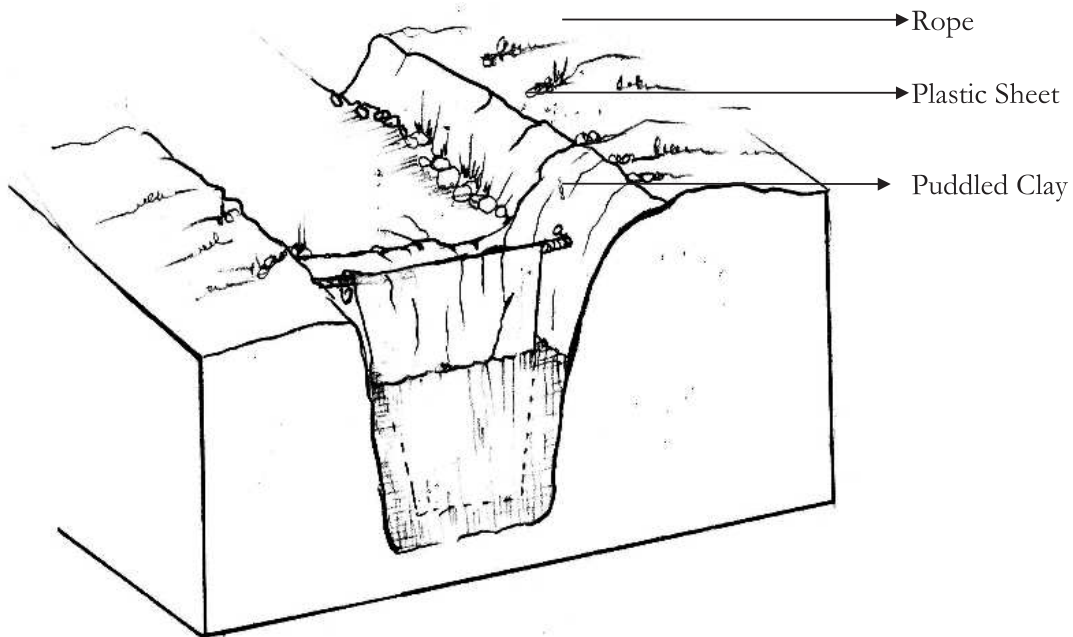

: . . . after puddled clay balls have been piled up on both sides of the sheet, then the remaining sheet should be unrolled from the rope and pulled to the top

Figure 11.3: Where the trench is deep, the plastic sheet may have to be inserted like this

Where the trench is deeper than 3m., there is a danger that the plastic sheet may tear. The people who enter the trench for trampling the clay balls may find it difficult to breathe. In this case, it is best to roll the plastic sheet around a rope and tie it halfway up the trench. When the trench gets filled upto that point, unroll the rest of the plastic sheet (Figure 11.3).

In the first method, the mud is completely surrounded by the plastic sheet. It becomes virtually impossible for water to flow through the dyke. However, if there are boulders embedded in the walls of the trench, there is a danger of the plastic sheet getting torn. Moreover, the water can find an escape route in the gap between the bottom of the trench and the plastic sheet. In the second method, such problems do not exist.

11.4 Boulder Check on Top of the Dyke

After the dyke has been constructed, make a boulder check on the bed of the drainage line. If a dyke and a boulder check are made together, the efficiency of both increases. The surface flows in the drainage line will get obstructed by the boulder check and will percolate underground. This recharge of groundwater will be further reinforced by the dyke. But a boulder check must be made only after an understanding of the slope of the drainage line and the velocity of surface runoff.

11.5 DOs and DONTs in Dyke Construction

- ✘ Do not construct a dyke where subsurface flows dry up within 3 months after the monsoon.
- ✘ Do not locate a dyke where subsurface flows are available only at a very great depth.
- ✘ Do not locate a dyke where the bed slope of the drainage line is very high.
- ✘ Do not construct a dyke if impermeable strata are only available at a depth greater than 20 ft., because the costs will outweigh the benefits.
- ✓ Locate a dyke near wells/handpumps.
- ✓ Ensure that the dyke is perpendicular to the overall direction of flow of the drainage line.
- ✓ Continue excavation of the trench until relatively impermeable strata are encountered
- ✓ Ensure that the clay filling is well watered and puddled.
- ✓ Ensure that inside the trench the puddled clay balls are compacted properly.

12 | Drainage Line Treatment and Water Harvesting: Earthen Dams



The most important structures of any watershed programme are the earthen dams built on the main stream of the watershed.

12.1 Objectives

Earthen dams can be of 2 major types depending on their primary objective:

1. **Irrigation Dam:** Such dams can be constructed to meet two different kinds of demands:
 - * of storing water during the rainy season to be used for irrigation in the **post-monsoon** period.
 - * of providing **protective irrigation during dry spells within the rainy season**. Most parts of India typically receive rainfall between June and September, very intensely within a few hours and a few days. The number of rainy days does not average more than 40-50. Moreover, rains are extremely erratic, often characterised by late onset and early withdrawal. Prolonged

dry spells during the rainy season, resulting in agricultural droughts, are also frequent. Hence, the kharif crop needs to be drought-proofed through 'protective' irrigation, applied to overcome accumulated soil moisture deficits *within the rainy season*. Such structures are especially important in areas which are poor in groundwater resources and which do not have access to canal irrigation. Such areas form about half of India's agricultural area.

2. **Percolation Dam:** Percolation dams are constructed for recharging groundwater. Such structures are usually made on the upper part of the catchment area. Water stored here percolates to wells and tubewells located in the lower part of the catchment. Such dams can also be made in the immediate upstream portion of wells and tubewells. Depending on the capacity of the dam and duration of water storage, the dam can have secondary benefits (such as pisciculture) that are vital for the livelihood security of marginal farmers and landless labourers.

12.2 Location

Deciding how to locate an earthen dam requires balancing many considerations and arriving at the best possible solution.

1. **Balance between Catchment Area and Storage Capacity:** The first is to create the best possible match between the **storage capacity of the dam** and its **catchment area**. The space for storing water made available by a dam is called its storage capacity. The area from where the dam collects ("catches") water is called its catchment area. Size of the catchment area determines the volume of runoff that enters the dam. A common mistake is to locate earthen dams at places where the catchment area of the stream is very large or very small in relation to the dam's storage capacity. If the catchment area is small, then the structure will never get filled. On the other hand, if the catchment area is too large, the inflow of water will be much higher than its storage capacity. Such a structure would necessarily have to let most of its inflow out through an surplus weir, which literally means that we end up diverting the entire stream! Hence, the catchment area of the site selected for construction of a dam should neither be too high nor too low in relation to the storage capacity of the dam.
2. **Embankments of the Drainage Line:** We must also try to ensure that where the dam is located the drainage line should have **well-defined embankments** so that we can anchor the dam into them. Well-defined means at least three things – that the embankments are high, close to each other and firm (not made of loose material like sand).

3. **Slope of the Drainage Line:** Ideally, upstream of this site, the **drainage line should be relatively flat** (bed slope not more than 5%). This helps maximise storage capacity.
4. **Upstream Width of the Drainage Line:** As we move **upstream** of the dam site, it would be good if the **width of the drainage line** increases, so as to contain maximum storage within its banks.
5. **Geology:** In an **irrigation** dam, the water spread area and the natural embankments should be **impermeable**. In a **percolation** structure, the natural embankments should be impermeable but the water spread area should comprise relatively more **permeable** material.
6. **Availability of Materials:** Even with all other factors favouring a site, we may be compelled to abandon it if the **requisite materials** (earth, boulders, water etc.) are not easily **available**. This could make costs of transporting material prohibitively high.
7. **Exit:** It is very important to be able to find a proper location for the **surplus weir** at the dam site. We know that if water flows over the top of an earthen dam it will break. Hence, the surplus weir is required to channelise excess runoff safely out of the structure. It serves the same purpose as the safety valve in a pressure cooker. The surplus weir should be located at a place that involves the least amount of excavation. Ideally, the bed of the surplus weir should not be erodable. Of course, we could protect the exit through stone pitching or masonry. But this will add to costs. It can also happen at times that the site is surrounded by farmers' fields who do not give you land to make the surplus weir. In such cases, you may even have to abandon the site, howsoever reluctantly!
8. **Submergence:** Linked to this is the most important fact that a dam that is ideal from an engineering standpoint, may be socially unacceptable if it happens to **submerge land** considered valuable by the community or even by a single intransigent farmer. Or forest land for which the Forest Department refuses to give permission!

Thus, deciding upon the location of a dam is a complex issue that involves juggling a number of topographic, geological, economic, social and legal considerations. In practice, this involves an iterative process where we ascertain the storage potential (as explained in detail in the Appendix to this chapter) of at least 3-4 sites on the stream. We then judge which one of them is the best in terms of all the factors listed in this section.

12.3 Design

In Chapter 3 we have already explained why it is neither desirable nor possible to capture the entire surface water run-off within the watershed. In any case, no single earthen dam can do this. A thumb rule we have devised to make an earthen dam cost-effective is that it should aim to capture no more than 40%¹ of the season's total surface water run-off. If we aim for more, the dams are likely to be over-designed involving a waste of precious financial resources.

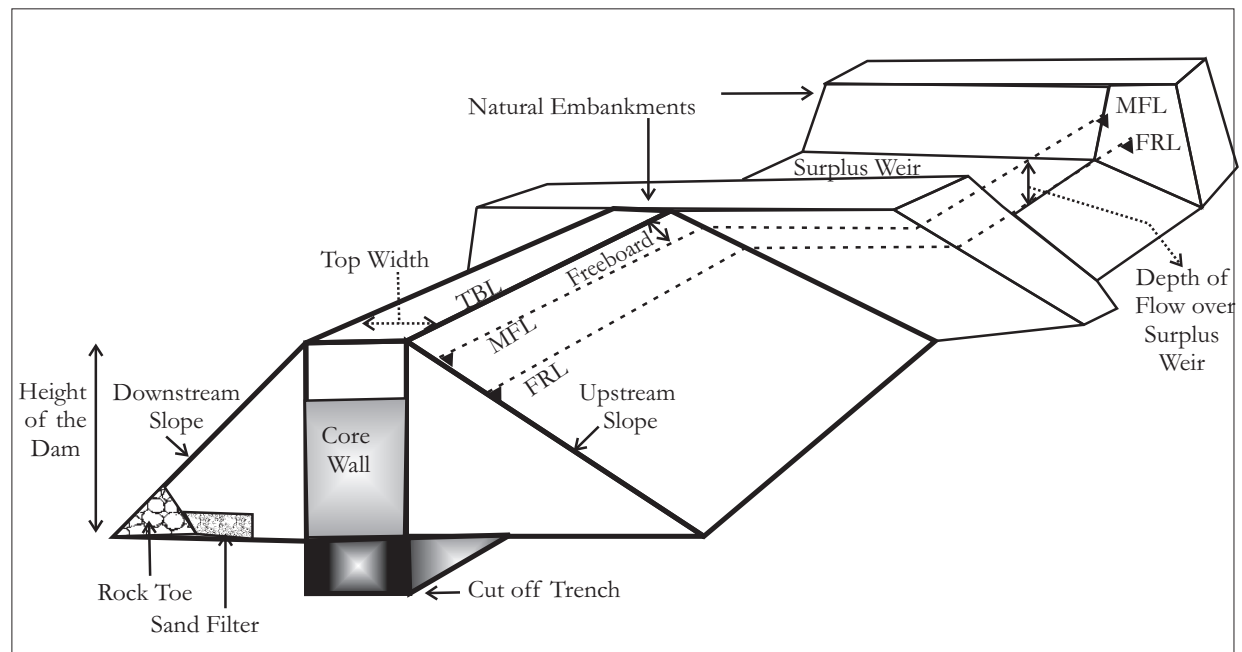

Figure 12.1: The design of an earthen dams and its main parts

12.3.1 Full Reservoir Level (FRL)

The FRL indicates the maximum level up to which water will rise when the structure is full. The FRL is determined bearing in mind the total runoff in relation to the effective storage potential of the site, which in turn depends on the shape of the side embankments, the upstream bed slope and geology of the drainage line and its width. The precise method of determining the storage potential of the site is provided in the Appendix to this chapter. Once we know the storage potential, how high we keep the

¹ We know that rain in most parts of India falls in spells within a 4-month monsoon period. An examination of data on intensity of rainfall from all over the country suggests that any one spell is unlikely to yield more than 40% of the season's total run-off. Our small dams should not, therefore, be designed to capture more than this. As Tideman says "In engineering design it is uneconomical to design structures to cope with extreme events. A designer takes a calculated risk and designs a structure that will accommodate the largest rain storm that can be expected during a particular time interval" (Tideman, 1996).

FRL is determined by specific conditions at the site, such as height of the embankments, upstream bed slope, width of the drainage line and maximum permissible submergence. The submergence permissible in any such structure would depend upon the nature of the catchment: in particular, whether it is inhabited, forested or whether it includes fertile agricultural land. The permission of those whose lands may be getting submerged would also need to be obtained prior to fixing the FRL. They should be actively involved in the planning and design of such structures from beginning to end. In case they suffer a loss due to the structure, they must be adequately compensated, possibly through sharing the benefits from the structure with them.

12.3.2 Surplus Weir

Water in excess of the FRL is drained out by the surplus weir. The base of the surplus weir is at the FRL. Spells of rain can vary greatly in intensity. There may be a sudden storm and dangerous amounts of water may have to be dealt with. A safety valve is required that lets some of the runoff go. This is especially important in earthen structures where the absence of such a safety valve would lead to water flowing over the top of the structure. This would definitely break the dam.

Therefore, we want to give water a way out through an outlet as soon as our structure has filled up. To drain this excess out, the size of the exit has to be able to deal with the maximum possible rain that can fall every second. We know that this volume of rain is called the peak runoff. The size of the exit or surplus weir has to be big enough for this peak runoff volume to pass through. In other words the maximum possible rain should get in and get out of the dam at the same time and with the same speed, simultaneously, so that the water level in the dam does not rise above the FRL.

The dimensions of the surplus weir are determined by taking into consideration the **peak runoff** from the catchment. The surplus weir must have the capacity to drain out safely the peak runoff when the water is at FRL of the dam. Peak runoff from a watershed is estimated as per the **Rational Formula**:

$$\text{Peak Runoff } Q_p = C \times I \times A$$

where Q_p = peak runoff in cubic meters per second

C = coefficient of runoff

I = intensity of rainfall in millimetres per hour

A = catchment area of the structure in hectares

The discharge capacity of the surplus weir has to be equal to the peak run-off. The discharge capacity (DC) of the surplus weir is given by the Crested Weir formula:

$$DC = 1.75 \times L \times H^{\frac{3}{2}}$$

where, $L = \text{Length of the Weir (m)}$

$H = \text{Depth of flow through the weir}$

(the height to which we would allow
water to rise inside a surplus weir) (m)

Wherever possible, for a given volume of excess runoff it is better to have a broader surplus weir than a deeper one so that storage capacity of the dam is not unnecessarily reduced. We do not want the water in a surplus weir to rise above a certain height. Thus, value H is the something we have decided. We have also calculated Q_p through the Rational Formula. So we need to arrive at the value of L , the length of the surplus weir.

Since DC has to be equal to Q_p , we can write:

$$Q_p = DC = 1.75 \times L \times H^{\frac{3}{2}}$$

$$L = \frac{Q_p}{1.75 \times H^{\frac{3}{2}}}$$

Generally, it is also advisable to check in the field whether the values arrived at by this formula are correct. We should consult the local people and ask them the maximum height to which water rises in the main drainage line flowing into the dam during an intense rainy spell. We should measure the cross section of the stream at this height. The cross section of the surplus weir should in no case be less than the cross section area of the stream when the flow is the maximum.

It is not always that the surplus weir is straight or horizontal. At times, the surplus weir may be slightly curved and may have a slope. It is a common mistake, in such cases, to calculate the freeboard, MFL etc., from the bottom edge the surplus weir. For all calculations related to MFL and the freeboard, only the **highest point of the floor of the surplus weir** should be taken.

12.3.3 The Maximum Flood Level (MFL)

The MFL is the maximum level up to which water is allowed to rise in a structure after an intense spell of rain. This provision takes care of extraordinarily high floods, which might damage the structure because it takes time for flood water to move out of the surplus weir. This may happen especially when there are temporary obstructions in the surplus weir due to accumulation of fallen tree trunks, leaves etc. This is particularly important after the first rains. In very small (<5 metres) structures harvesting water from local catchments, the provision for MFL may not be necessary.

12.3.4 The Freeboard

Over and above the MFL, we provide an extra height to the dam, which is called the **freeboard**. Freeboard is the difference in height between the top of the bund and the maximum level up to which floodwater rises in a dam. Normally, the freeboard should be at least double the difference between FRL and MFL. It has been found through years of experience that for earthen structures with height less than 5m, a freeboard of 1m would be adequate. Keeping a higher freeboard makes the structure safer but it also reduces storage or makes the structure more expensive. Thus, while one must make full allowance for peak runoff, one must not give unnecessary freeboard beyond the level warranted by peak runoff.

12.3.5 Top Bund Level (TBL)

$MFL + \text{freeboard} = TBL$. The TBL refers to the top level of the dam. If water flows over the top of the bund in an earthen dam, the dam will break. Hence, unlike in masonry or boulder structures, the excess water cannot be directed over the top of an earthen structure. Therefore, the TBL in all earthen structures has to be kept higher than the FRL/MFL.

12.3.6 Top Width

Top width of dams varies with the height and purpose of the dam. For earthen dams in the range of 3 to 6 metres height, top width is kept in the range of 1 to 2 metres. If the top is to serve as a road, the top width will need to be more than 2m. The top width may be determined by the empirical formula,

$$W = 0.4 \times h + 1 \quad \text{where, } W = \text{top width of bund}$$

$$h = \text{maximum height of bund}$$

12.3.7 Upstream and Downstream Slopes of the Dam

The upstream slope of the dam is subject to erosion by the **sloughing action** of waves and by receding water. The downstream slope of the bund is subject to erosion by intense rainfall and the **scouring action** of flowing water. In order to protect the dam from such erosive action, the slopes of the dams must be very carefully determined. The precise upstream and downstream slopes of the bund depend on the **angle of repose** and **erodability** of the materials used in the outermost face. However, it is necessary to provide a lower slope on the upstream side than the downstream side to counter the sloughing action. Through experience it has been found that for a stable earthen structure, the upstream slope should range from 1:2.5 to 1:4. The downstream slope

should range from 1:2 to 1:3.

12.3.8 Settlement Allowance

The soil used on an earthen dam is usually compacted to a certain degree. Even the, this artificial compaction can never match the state of **natural compaction** in which the materials are found on earth's surface. Hence, a certain allowance has to be made for natural process of compaction due to the weight of the dam, movement of its materials towards their **natural angle of repose**, the increased moisture caused by water storage and the direct impact of rainfall. This allowance to be provided for this settlement depends on the type of fill material and the method of compaction used. Unlike masonry dams, the final height of an earthen dam will be lower than the height immediately after construction. This means that while constructing earthen dams, their height should be kept about 10 to 25% in excess of the design height. It is a very common mistake found in earthen dams that the settlement allowance is either not provided at all or is inadequate. Hence, when the dam settles to its final height, it leads to water flowing over the structure and breaking it. It must also be remembered that the dam would settle the maximum in the portion where its height is also the maximum, i.e., over the deepest portion of the drainage line. This is because the quantity of piled up material is the maximum here. Thus, the earthen dam must be made convex shaped with the middle portion being higher than the sides.

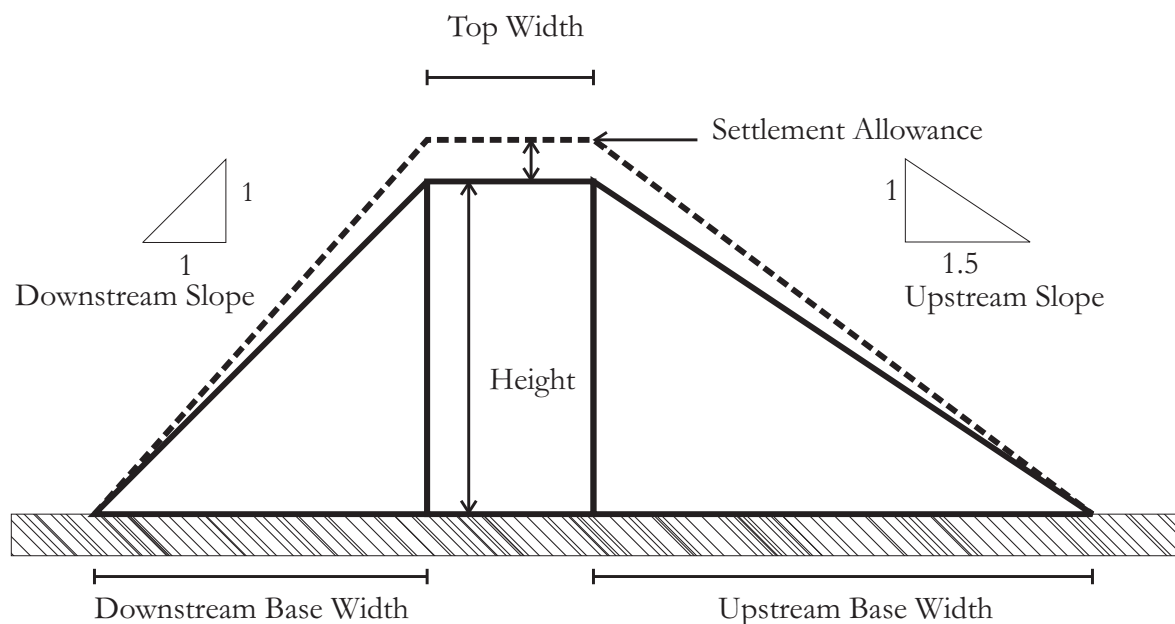

Figure 12.2: The settlement allowance of an earthen dam

12.4 Construction Step by Step

12.4.1 Trial Pits

At three or four places in the proposed dam site, experimental pits of 1m. x 1m. should be dug. Fill water in these pits to get an idea of the percolation rate of the proposed site. The site should be abandoned if the percolation rate is too high. Trial pits also help us determine the depth of the cut-off trench along the base of the dam. A third purpose of the trial pit is to assess the strength of the strata underlying the dam.

12.4.2 Site Clearance

Remove all vegetation at the proposed site. Scrape the location to 10 cm depth. All tree roots as well as sand, stones etc., at the site should be removed. "Toothing" should be provided at the proposed site by making the base of the dam uneven. This helps better grip of the structure on the ground.

12.4.3 Layout

Draw a line along the centre of the proposed bund from embankment to embankment (**centre line**). Determine the FRL and TBL of the structure. At 4 metre intervals on the centre line, use the dumpy level to mark a series of points where the dam will be raised to TBL. Settlement allowance must be added to this height at each point. On the basis of the slope parameters decided, indicate distances on the upstream and downstream side at each point and draw lines through these points. Care must be taken to provide the required top width exactly in the middle of the bund. For instance, if the maximum dam height is 5m, top width 2m and upstream and downstream slopes 2.5:1 and 2:1 respectively, the upstream edge of the dam must be marked at $(5 \times 2.5) + 1 = 13.5\text{m}$ distance and the downstream edge at $(5 \times 2) + 1 = 11\text{m}$ distance.

12.4.4 Cut-off Trench

We need to prevent the water we have stored in an earthen dam from seeping out below the base of the dam. For this we dig a cut-off trench and fill it with puddled clay.² The purpose of the cut-off trench is not to provide a foundation but to control excessive seepage below the dam wall. Unlike masonry dams, earthen dams do not require a foundation.

Dig a 1m wide trench of required depth along the centre line of the proposed dam. The trench must extend at least till the point where the top of the bund meets the embankment on both sides. The excavation for the cut-off trench should continue till

² Only where the stream bed is made of impervious material, a cut-off trench may not be necessary

all pervious materials such as sand are completely removed. You must dig on, even if water is encountered. In earthen dams, the depth of the cut-off trench is usually fixed as 25% of the TBL or till an impervious strata is reached, whichever comes earlier. After excavation, the base of the cut-off trench should be rammed thoroughly by watering. Fill the trench with 30-35 cm thick layers of puddled clay. Each layer should be properly watered and rammed into the layer below. Ramming inside the trench is usually done by labourers walking on the puddled clay.

12.4.5 Horizontal Sand Filter/Rock Toe Drain

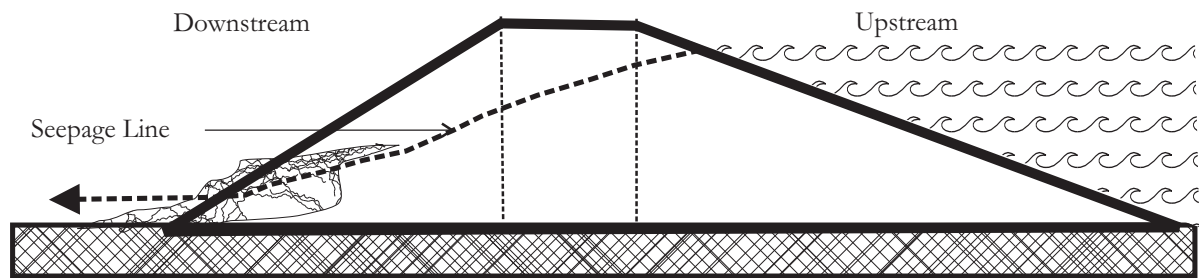

A. The seepage line going through the dam poses a risk to the safety of the dam

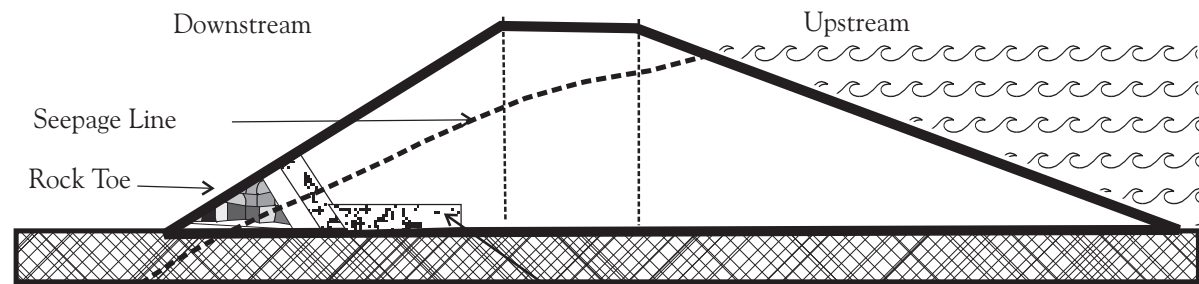

B. The rock toe and sand bed drag the seepage line down so that it does not go across the dam, thereby breaching it

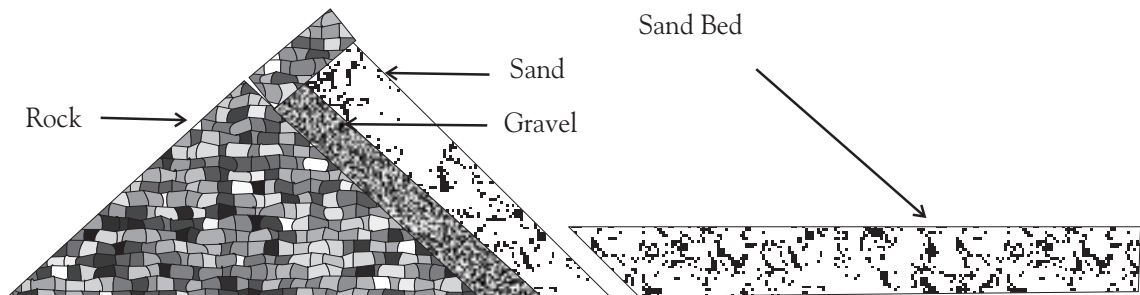

C. Close-up of Rock Toe and Sand Bed

Figure 12.3: The seepage line and rock toe

Even in a relatively impervious structure, some amount of water stored in a reservoir percolates from the upstream side to the downstream through the body of the dam, thus forming a **seepage line**. If this line emerges above the base of the dam, it would slowly cut into the downstream side and gradually erode it (see Figure 12.3). This would pose a serious threat to the stability of the structure. In order to drag the seepage line downwards so that the water is drained within the base of the dam, 30 to 50 cm thick sand layers are placed inside the dam, at the base of the downstream portion, forming a **horizontal sand filter**. On the outermost side of the downstream portion, boulders are placed to drag the seepage line down, which forms the **rock toe drain**. The rock toe is usually constructed in the design of a **reverse filter** with each subsequent layer increasingly coarser than the previous layer. The filter material must be more pervious than the bund material so that the seeping water can be rapidly removed.

12.4.6 Embankment and Corewall

Depending on the construction materials used, earthen dams can be classified into three types:

1. **Dams of Homogeneous Material:** In places with an impervious foundation where availability of clay is virtually nil, dams can be made from relatively more pervious material by increasing the cross-section area of the dam (see Figure 12.4). Watering and ramming should be carefully done in such dams. The cross section of this type of dam should be made broader by providing lower slopes on the upstream and downstream, as well as by increasing the top width.
2. **Core Wall Type Dam:** Where both pervious and impervious material are available, the dam wall can be partitioned between these according to their relative abundance (see Figure 12.4). Where the availability of impervious clayey soil is limited, we can choose to economise on clay by watering and kneading by human labour (**puddling**). In the core wall type dam, there is a narrow, impermeable, puddled clay barrier, extending from side to side. The clay is soaked, kneaded and rammed to make a thin impermeable wall. This forms the **corewall** of the dam. The cut-off trench is filled with puddled clay till ground level is reached. This is a labour intensive method but it maximises impermeability of clay. To support and protect this, the outer flanks of the dam are made of rammed coarser soils, which are arranged by grade. The finest particles are placed inside, graduating to the coarsest material on the outer face of the dam. The final shelter is provided by stone pitching, which involves placing a layer of boulders on the upstream face of the dam.
3. **Hearting and Casing Type Dam:** Where clay is available easily and in large

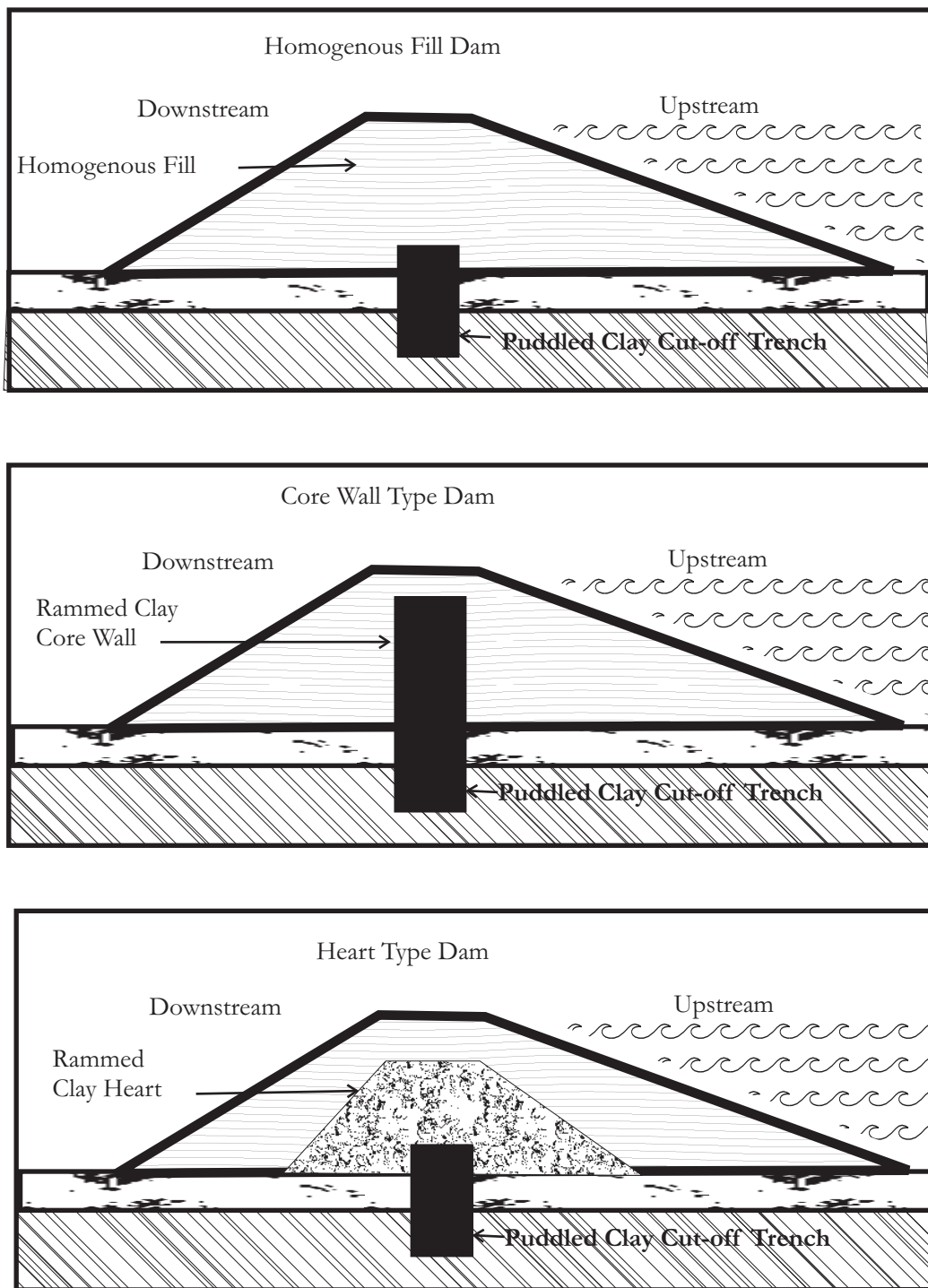

Figure 12.4: Three types of dams

quantities, it is possible to construct the **heart** of the dam with wetted and rammed clay, and provide a **casing** of coarser soils to protect it. Here, a thicker wall of clay is raised by laying, wetting and ramming (see Figure 12.4). The inner clay wall will also have side slopes, unlike the corewall, which is vertical. After the cut-off trench has been filled, the dam wall is raised in horizontal layers. Even in situations where

pure clay is not available, it is possible to make an earthen dam using finer soils for the heart of the dam and coarser soils for casing.

In all three types of dams, care must be taken to raise all sections of the dam together. In a corewall type, the puddled core wall and the shell must be simultaneously raised. Corewall needs to be constructed only till the FRL is reached. In the hearting and casing type, both the hearting and the casing must be done together. The layers should be 6 to 8 inches on either side which are laid, wetted and rammed. While laying, it should be kept in mind that the finer soils should be laid inside, i.e, closer to the clay core, the coarser soils should graduate outwards. As layer after layer gets compacted, the width of the casing is reduced to create the slopes of the upstream and downstream sides of the dam till the desired height is arrived at.

12.4.7 Slope Maintenance

Upstream and downstream slopes of the dam must be carefully maintained. For this, it is advisable that side slopes are made as a series of steps. These steps are necessary for the labourers to walk up to throw the material. Even more importantly, they allow us to make mid-term corrections in case the slopes go a little off the mark. Towards the end of the construction, the steps should be broken and a continuous slope provided.

12.4.8 Stone Pitching and Grass Turfing for Embankment Protection

As mentioned already, the outer faces of the dam are subject to erosion by water. To protect the upstream face from the sloughing action of waves, stone pitching is done by using boulders of size 15-30 cm width. Use stones which are flat on one side and angular on the other. The area of stone pitching depends on the FRL of the dam and its upstream slope. Where boulders are not easily available, the freeboard zone on the upstream face and all of the downstream face can be protected by planting grass (**grass turfing**). The grass roots form a protective web that binds the soil together. The grass blades also cushion the force of raindrops making them less erosive. Grass turfing should be done before the monsoon begins.

12.4.9 Surplus Weir

After the construction of the main dam is over, surplus weir must be constructed.³ The site for surplus weir should be chosen in such a way that it minimises excavation.

³ In extraordinary circumstances where the monsoon is rapidly approaching and completing the dam before it appears difficult, we may also make the surplus weir first, in order to protect the work already done on the dam.

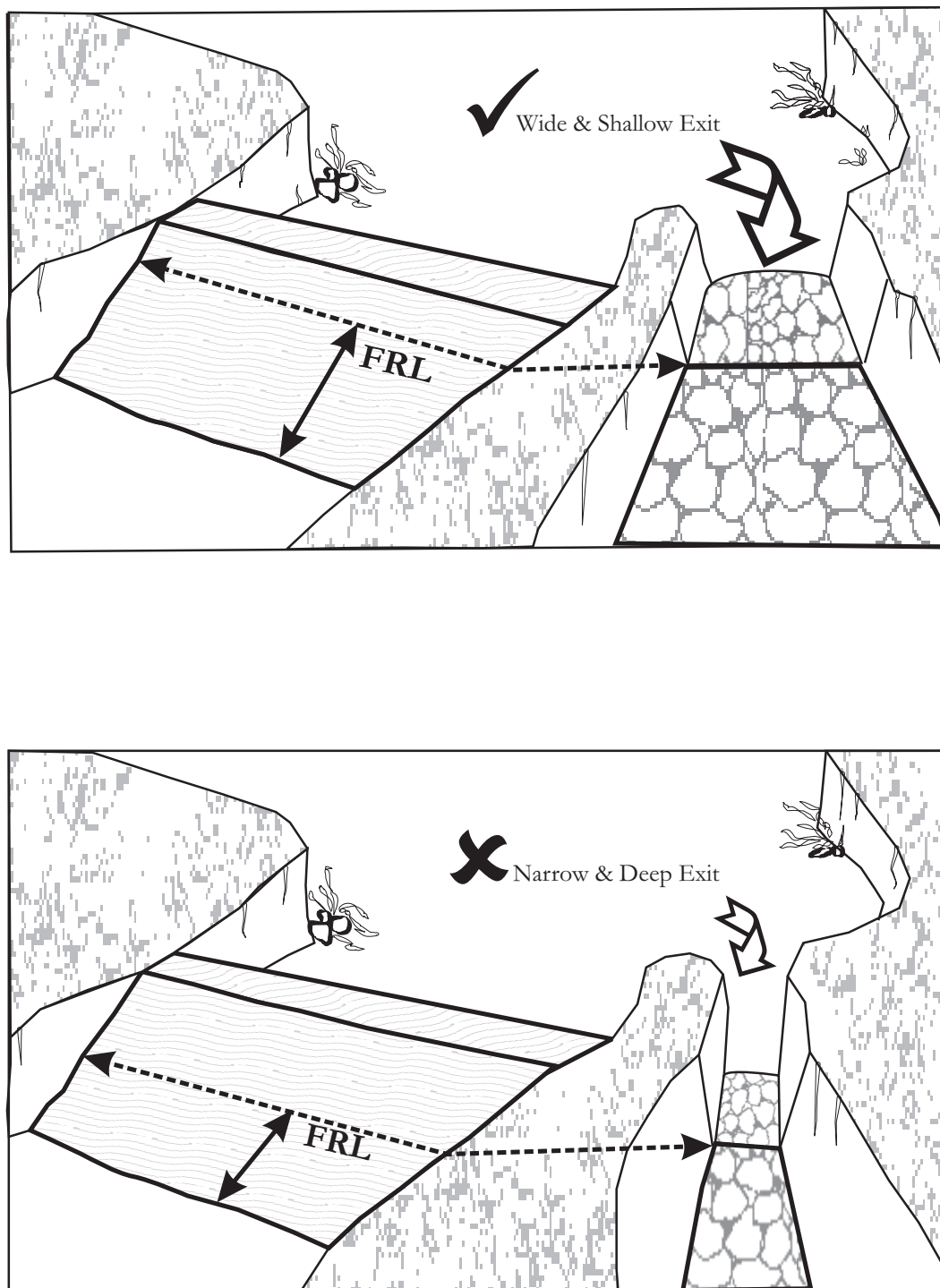

Figure 12.5: How to and how not to make the surplus weir

As far as possible, the surplus weir should be connected to some natural drainage channel flowing nearby so that the excess runoff does not cause further erosion. The following points also should be kept in mind while constructing surplus weirs:

1. In some cases, it may be difficult to provide a surplus weir on the side of the dam due to adverse topography or geology. In such cases, a stone or cement masonry

weir must be provided in the main body of the dam itself.

2. All types of surplus weirs should have adequate protection of their sides and bed through stone pitching or stone/cement masonry.
3. The surplus weir should not be very steep or have sharp curves. High slopes and sharp curves would both increase the danger of soil erosion.

12.5 DOs AND DON'Ts

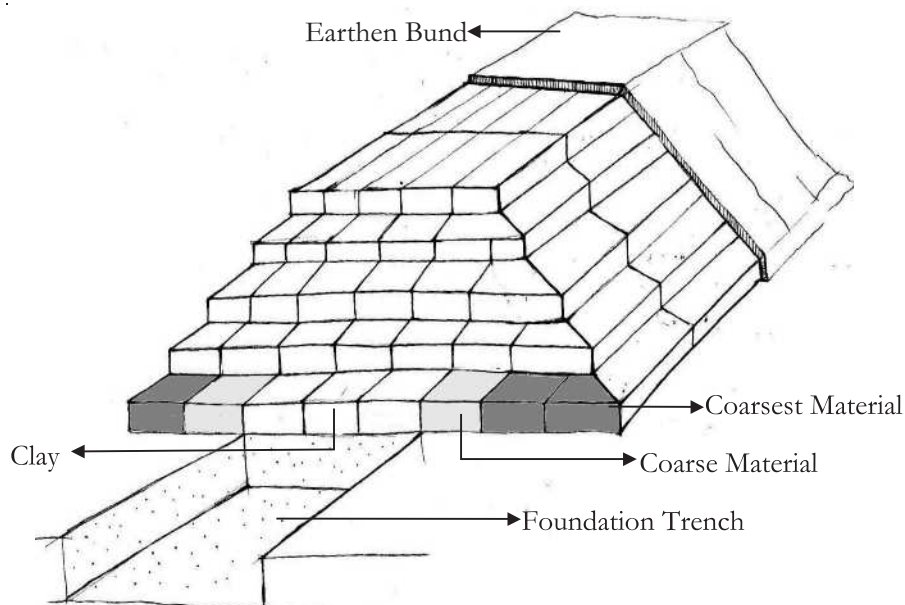

An earthen bund “peeled off”. Built layer by layer, the materials get progressively coarser as we move from the inside to the outside

Figure 12.6: An inside view of an earthen dam showing its various layers

- ✓ The effective storage capacity of the dam should not be either too large or too small in relation to runoff.
- ✓ At the dam site, the drainage line must have well-defined embankments into which the dam can be anchored.
- ✓ The permission of those whose lands may be getting submerged would also need to be obtained prior to fixing the FRL. Effort must be made to actively involve them in the planning and design of such structures from beginning to end.
- ✓ The upstream slope of the dam should be lower than the downstream slope
- ✓ The surplus weir must be properly designed to drain out the peak runoff safely when the water is at FRL.
- ✓ Adequate settlement allowance must be provided for in earthen dams.
- ✓ Rock toe must be provided to drag the seepage line downwards.

- ✓ The bed of the drainage line upstream the dam site should not have a high slope.
- ✗ Do not use highly erodable material like clay on the outer faces.
- ✗ Do not raise the corewall over the FRL of the dam.
- ✗ The surplus weir should not be very steep or have sharp curves.

12.6 Looking Ahead: Estimation of Reservoir Capacity

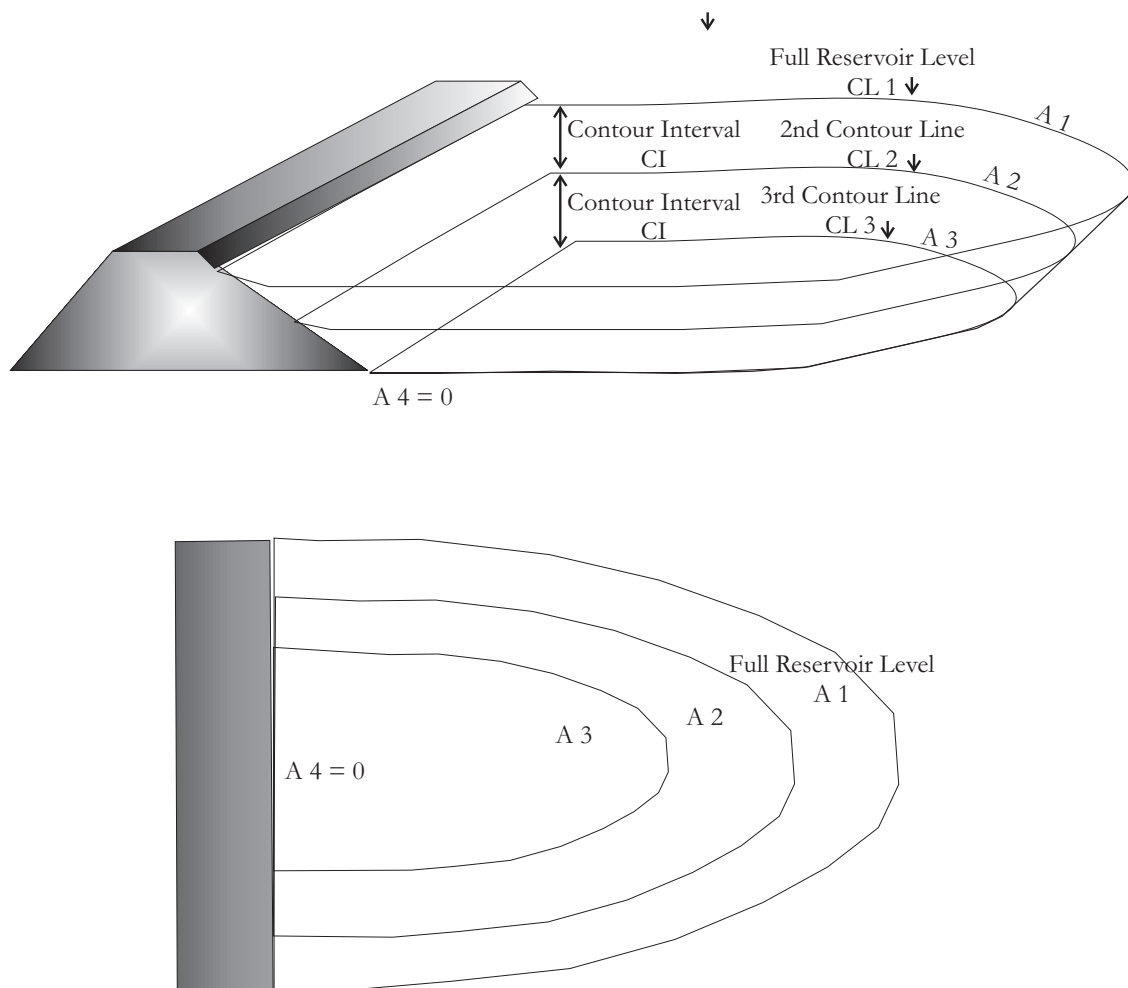

Figure 12.7: The cross section and plan of the dam and reservoir

To estimate the storage capacity of a dam, it is necessary to conduct a detailed contour survey of the proposed dam site. The first contour is drawn at the FRL (CL1). Successive contour lines are drawn at 1 or 2 metre vertical intervals (CL2, CL3 etc). These contour lines are then transferred to a graph paper and area of water spread at each contour is estimated (A1, A2 etc.). Multiplying the average of the area at two

successive contours with the contour interval (CI) gives us the volume of water stored between two successive contour lines.

$$\text{Volume of water between CL1 and CL2} = V1 = \frac{(A1 + A2)}{2} \times CI$$

$$\text{Volume of water between CL2 and CL3} = V2 = \frac{(A2 + A3)}{2} \times CI$$

$$\text{Volume of water between CL3 and CL4} = V3 = \frac{(A3 + A4)}{2} \times CI$$

$$\text{Total Storage Capacity} = V = V1 + V2 + V3$$

However, the storage capacity indicates only the amount of water that the structure can hold *at any point of time*. To arrive at the volume that the structure can usefully harvest *during a season*, we should add the amount of water percolating from it during a season to its storage capacity. This is called the **effective storage** of the structure. To determine the water percolating from the structure, we dig trial pits and study the time taken for water to empty out from these pits. This **infiltration rate** is multiplied by the surface area of the reservoir and the duration of the season, to arrive at the volume of water that we need to add to the total storage capacity. While computing the irrigation potential and cost per unit of water harvested, one should take effective storage rather than storage capacity into account.

$$\text{Effective storage capacity} = \text{Storage Capacity} + \text{Volume of water percolating from it during a season.}$$

13 | Farm Bunding



Farm bunds are constructed on agricultural land with the aim of arresting soil erosion and improving the soil moisture profile. Ideally, bunds on farms should be made on the contour line. But this creates several problems for farmers. Contour bunds divide the field into irregular sections. In such a situation, it becomes inconvenient to maneuver bullocks for operations such as ploughing and line-sowing. Due to these difficulties, what is normally practiced in the name of farm bunding is bunding along the field boundaries. In this chapter we will outline a practical middle path between the extremes of contour bunding and bunding on field boundaries, so that the benefits of bunding are made available to farmers without creating any problems.

13.1 Objectives

1. **Control of Soil Erosion:** In our country, rain falls in a few hours on a few days in a few months. After falling on the ground, rainwater carries off with it precious top soil. Due to this action of rainwater, rills are formed in fields, which soon become small drains. It must be remembered that every year in our country 6.6 billion tonnes of top soil and 5-8 million tonnes of nutrients are lost due to soil erosion. India is losing soil 30 to 40 times faster than the natural replenishment rate. We should also keep in mind that it takes over ten thousand years to form a 2.5 cm thick layer of fertile soil. It is estimated that if these soil losses are prevented

the productivity of agricultural can rise by 30-40%.

By dividing the field into several units, bunds control the volume and velocity of runoff in each such unit. The water in the field and the soil it is carrying are stopped at each bund. Thus, by not allowing water a long stretch of free flow, bunds break the momentum of water.

2. **Improvement of the Soil Moisture Profile:** Bunding improves and stabilises the soil moisture profile. What exactly is meant by "improvement"? The definition changes with changing local conditions:

- * In permeable soils (sandy or alluvial), the main aim of bunding is to stop runoff.
- * In impermeable soils (black or clayey), the purpose of bunding is to make arrangements for the safe exit of water out of the field. On the one hand, we aim to reduce the velocity of run-off. But since the soil is impermeable, this water will collect in the field and harm the standing crops. Thus, we also aim to provide an outlet to this water.
- * In fields with crops such as paddy, the purpose of bunding is to stop water in the field, regardless of the permeability or impermeability of the soil.

13.2 Planning

A plan for farm bunding can never be made for one field alone. Because in any field water flows in from the fields above it and flows out to the fields below it. Thus, it is important to plan for the entire stretch between the up-lying fields to the drainage line as a single unit. Therefore, it is crucial to involve all farmers in the village in the planning process. They must be informed about the proposed plan and its objectives. Only with their complete participation should the plan for bunding be finalised.

Even so, it may happen that farmers in the uplying fields may not agree to get their fields banded. In such a case, if bunding has to be done on low-lying fields, a diversion channel will have to be dug for the exit of water coming in from the fields above. But the problem becomes insurmountable if the farmers **below** do not agree. This is because water discharged from the fields above can completely destroy the crops in the fields below. Thus, consent of farmers below the field where bunding is to begin, is a must.

13.3 Spacing

The distance between bunds must be 30-80 m. This decision depends on the slope of the field. That is,

- * The greater the slope, the lesser the distance

* The lesser the slope, the greater the distance

In highly sloping land, water will run off very fast. Thus it will have to be stopped more frequently.

13.4 Design

13.4.1 Situation 1: In Relatively Permeable Soils

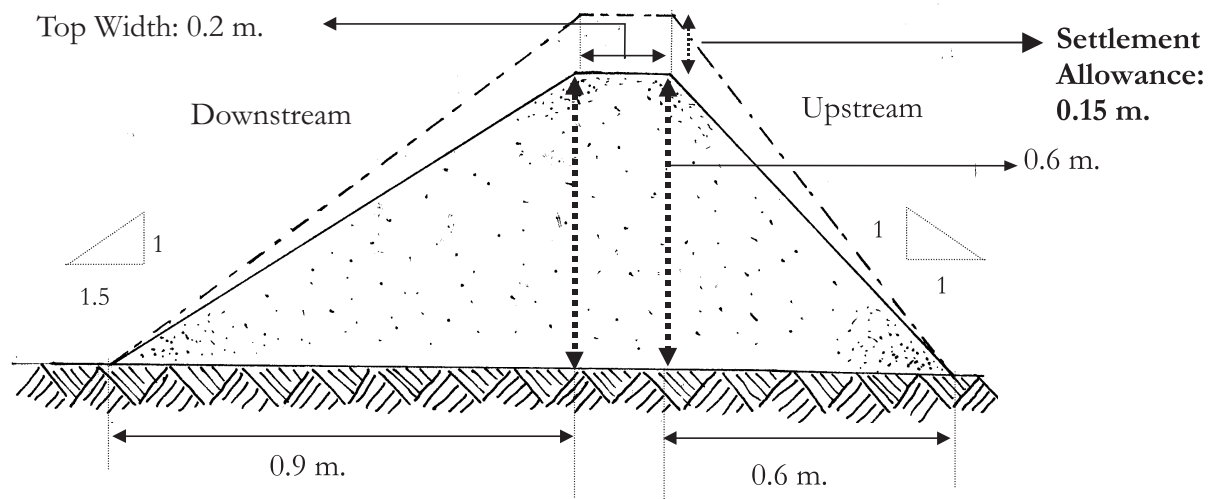

In constructing earthen dams and bunds, an adequate settlement allowance must be left

Figure 13.1: Cross section of a farm bund in permeable soil

1. **Height:** 60 cm (refer to Figure 13.1)
2. **Settlement Allowance:** 25%
3. **Thus, height of bund at time of construction:** $60 \times 1.25 = 75$ cm. In gravelly soils, the settlement allowance can be lowered to 10%
4. **Top Width:** 20-30 cm
5. **Upstream Slope:** 1:1
6. **Downstream Slope:** 1:1.5.
7. **Exit:** On relatively flat permeable fields, an exit need not be given. However, in sloping lands, there is every danger of the bund breaking without an exit. Rapidly flowing water may overtop the bund or slowly erode it. Therefore, provision of a stone exit becomes imperative. From the point of view of safety, it is best to provide an exit at the lowest point of the bund but in such a case no water will stop at the bund, rendering the bund meaningless. The exit should, therefore, be made a little above the lowest point of the bund. The water will stop at the bund for a short time and then flow out of the exit. In such cases, however, it is

extremely important to strengthen those sections of the bund which lie below the exit, since water will collect in these sections and create pressure on the bund.

8. **How Should the Soil be Excavated for Construction of Bunds?** Soil should never be excavated continuously because this will cause the formation of channels, which will erode soil and carry out water. Instead, several discontinuous trenches should be dug in which soil and water can collect. The width of these trenches should be 1 m. Where excavation is discontinued, a small *tooth* should be constructed at 90 degrees from the bund (see Figure 13.2). This tooth should be about 2 m. long and should have a maximum height of 30 cm. If stones are available, this tooth should be made entirely of stones. Otherwise, do not forget to provide a stone exit in teeth made of mud. In this way, there will be a series of trenches and teeth, which will act as repositories of water and prevent soil erosion. Farmers, according to their choice, can dig these trenches in two ways:

- a) deep and narrow, or,
- b) shallow and wide.

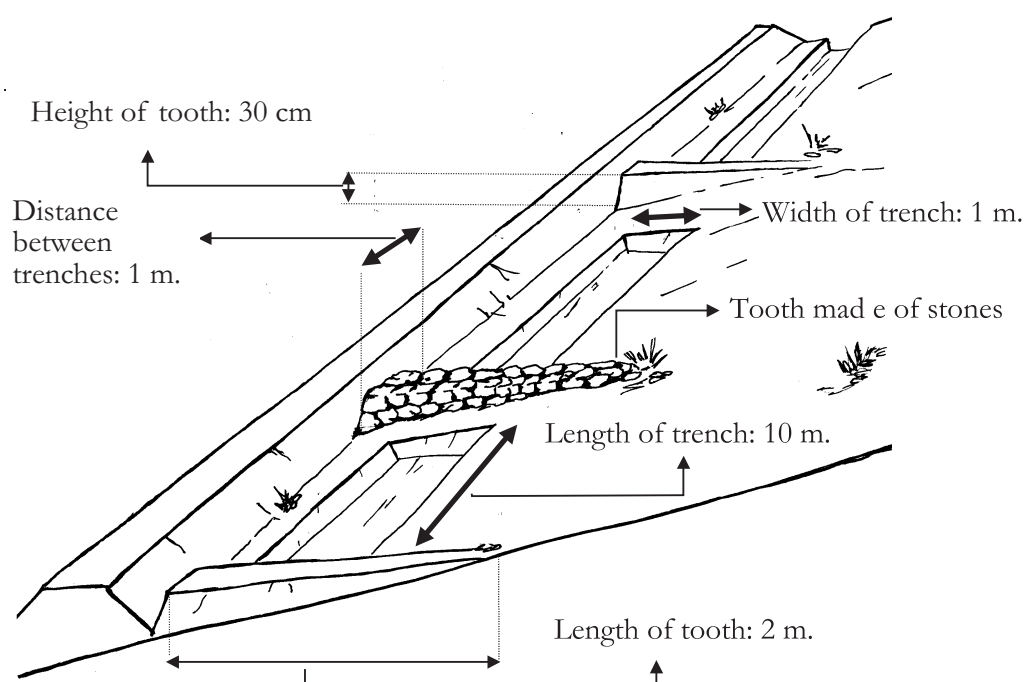

Excavation for construction of farm bunds should never be continuous. After digging a trench 10 m. long, a section of 1 m. length should be left undug. Here *teeth* should be made, originating from the bund. Water will collect in this chain of trenches and teeth and soil erosion will also be reduced.

Figure 13.2: Instead of digging the mud continuously, make *teeth* like these

In shallow and wide trenches, crops like paddy can be grown. On the other hand,

in a deep and narrow trench, less agricultural land is covered by bunding. The decision will ultimately depend on the farmer. However, no matter how the trench is dug, it will fill up with soil in a few years. Plants or crops (such as *tuar*, *arandi*, *til*) should be sown on bunds. The roots of these plants will stabilise the bund and arrest soil erosion. The plants are also an additional source of income.

13.4.1.1 Alignment of Bunds Under Different Conditions

The alignment of bunds requires several improvisations on the spot, depending on local conditions:

Example 1: When a rectangular field slopes along one diagonal or towards one edge of the field

In such a situation, ideally, contour bunds should be constructed across the slope of the field. However, as mentioned earlier, contour bunds will divide the field into irregular sections. Therefore, the bund should be constructed parallel to one of the field boundaries. In this way, since the bund will have a gradient, water will flow along it.

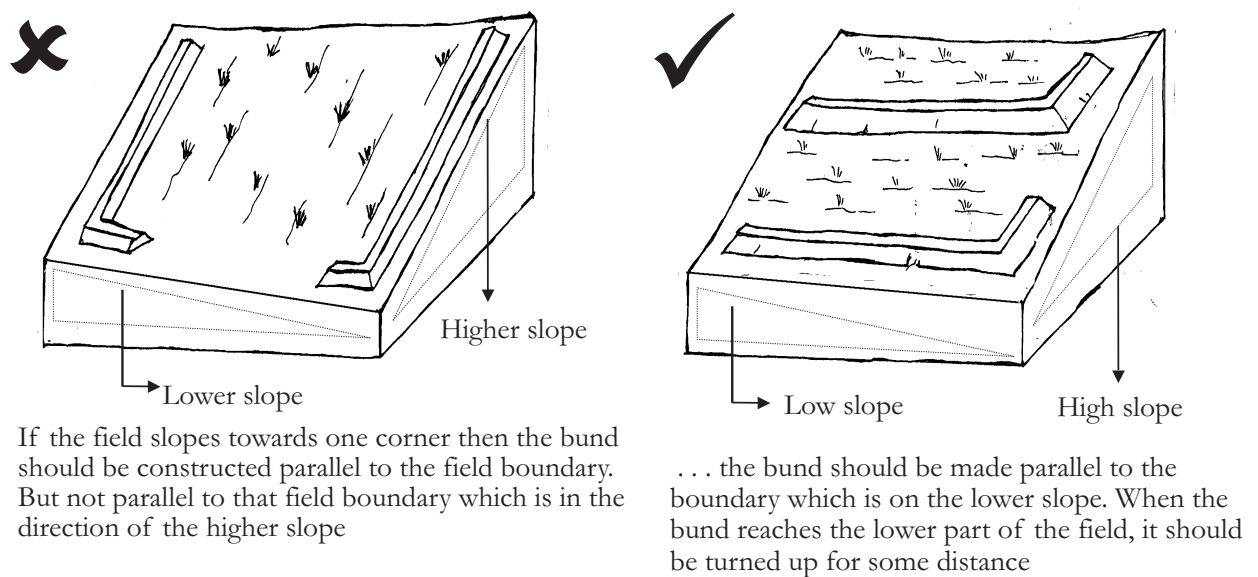

Figure 13.3: The wrong and the right way to layout bunds on sloping fields

Question: Parallel to which boundary should the bund be aligned?

Answer: It should be aligned parallel to the boundary which is along the lower slope. In this case, the velocity of flow of water will be decreased and more water will percolate into the field. At the end of the bund, turn it for a little distance at 90 degrees. This slows down the water and allows the water to collect. Give an exit after this turn.

Example 2: If the field has a two-way slope

If in such a situation, the bunds are aligned parallel to the boundaries, the velocity of runoff will only increase. Thus, first one bund should be constructed across one slope. Then the other bund should be constructed across the other slope. Both bunds should be joined in the middle. Such a bund will be almost like a contour bund. Remember to provide an exit in one or the other of the bunds.

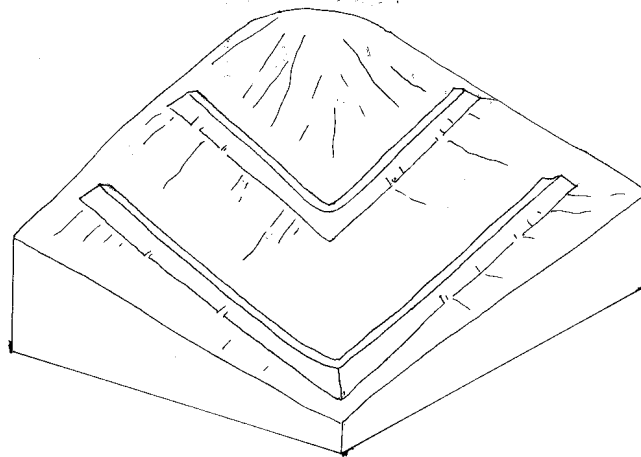

If the field has a two-way slope then one bund should be made across one slope. Then another bund should be made across the other slope. The two bunds should be joined together in the middle.

Figure 13.4: Farm bunds on a field with a two-way slope

Example 3: If the field has a one-way slope but there are several rills in it

In such a case, the bunds can be conveniently aligned parallel to one boundary. Suppose, however, that we construct the entire bund at a height of 60 cm from ground level. In such a situation, the top level of that section of the bund which passes across the rill, will remain lower than that of the rest of the bund, because the ground level itself is lower here. The result will be that water will flow over this section and breach the bund. Therefore, the section of the bund going across the rill should have a height greater than 60 cm. This situation reveals a fundamental principle of bunding: *The top bund level should be at the same elevation along the entire length of the bund, even if this means variations in its height when measured from ground level.*

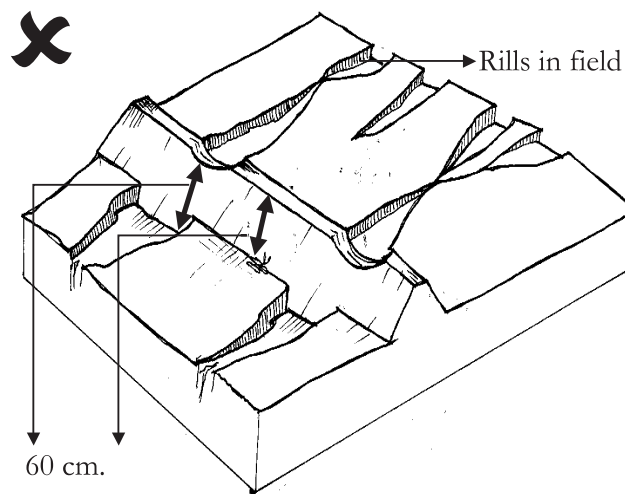

If there are rills in the field and the section of the bund crossing them has the same height as the rest of the bund, then this section will remain lower than the rest of the bund because here the ground level itself is lower. Water will top over this section and the bund will be breached

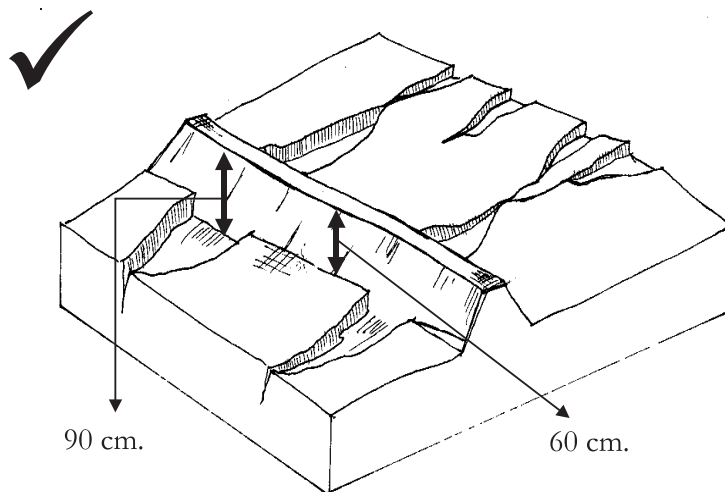

... therefore the section of the bund crossing over the rill must always be higher than the rest of the bund.

Figure 13.5: The top of the bund should be on the same level

13.4.2 Situation 2: In Relatively Impermeable Soils

In such soils, there is a danger of water collecting in the field.

1. **Height:** 50 cm (see Figure 13.6). In impermeable soils, water takes a longer time to percolate below the ground. Therefore, there is always a danger of it overtopping the bund and breaching it. Thus, an argument can be made that bunds in such soils should be higher. However, in black clayey soils, this may create waterlogging

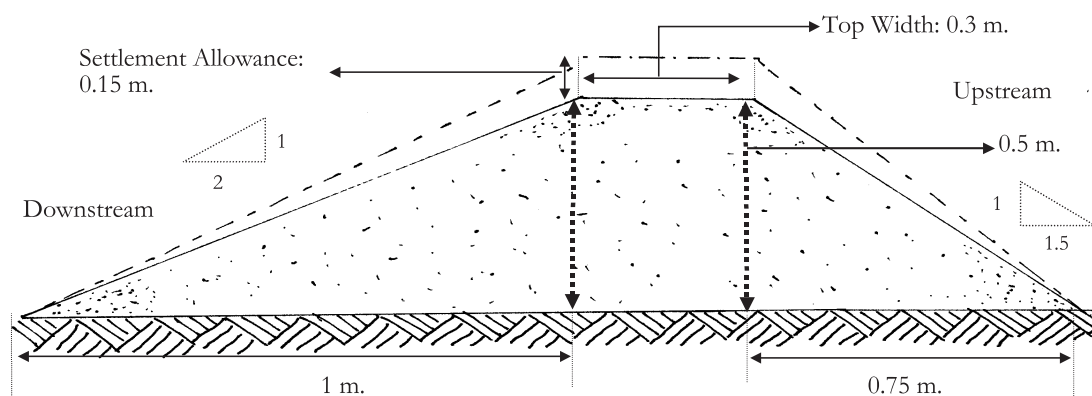

In impermeable soils, the upstream slope should be in the ratio 1:1.5 and the downstream slope in the ratio 1:2

Figure 13.6: Cross section of farm bund in impermeable soil

and may also endanger the bund. In order to get around this dilemma, the bunds should be kept at a lower height, but in order to avoid waterlogging, an exit should be provided. In black, clayey soils, provision of such an exit is a must. In addition, the distance between bunds should be reduced (20 to 50 m) so that no unnecessary pressure is created on any one bund.

2. **Settlement Allowance:** The fine particles of clay have a natural tendency to settle. Also, such soils are found as clods. Depending upon the shape of the clods, it is important to give a settlement allowance of at least 25%. As much as possible, the clods should be broken down, since the bigger the clods, the greater are the chances of the bund subsiding. The clods are best broken when they are dry.
3. **Top Width:** 30-40 cm. The width of bunds made of clayey soils has to be greater because when the clay dries up, it cracks. Moreover, on such bunds it is very important to plant grass etc. whose roots stabilise the bunds.
4. **Upstream Slope:** 1:1.5
5. **Downstream Slope:** 1:2 Since clayey soils have a greater tendency to settle, bunds made from them should have lower slopes than those made on permeable soils. In particular, special care has to be taken to prevent water from seeping through the cracks in the bund and emerging across on the other side. After some time, the water starts forming wide channels downstream of the bund. To prevent this, the **downstream slope of the bund must be lower than its upstream slope**. Its base width can be kept at 2.5 m. This will prevent the seepage of water through the bund since it will be difficult for the water to seep through a broad bund. Another way is to **give a gentle grade to the bund**. The water will flow along the bund

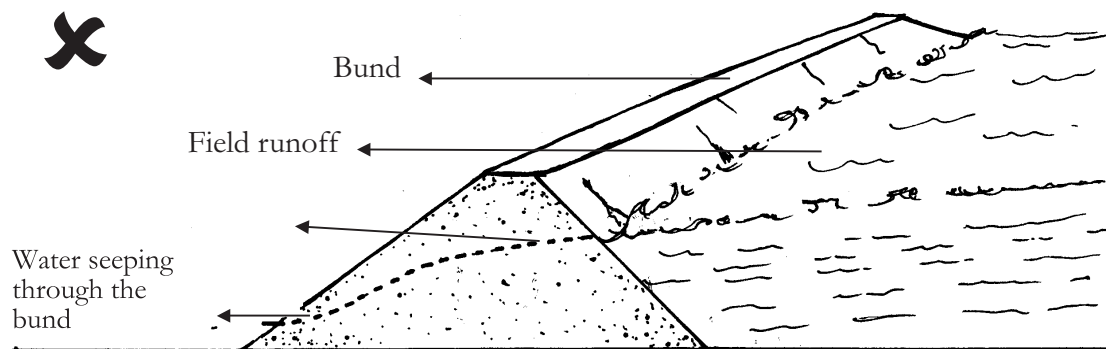

If in impermeable soils, the bund cannot be given a grade and its base is also narrow then the field runoff will seep through the drain, endangering the safety of the bund

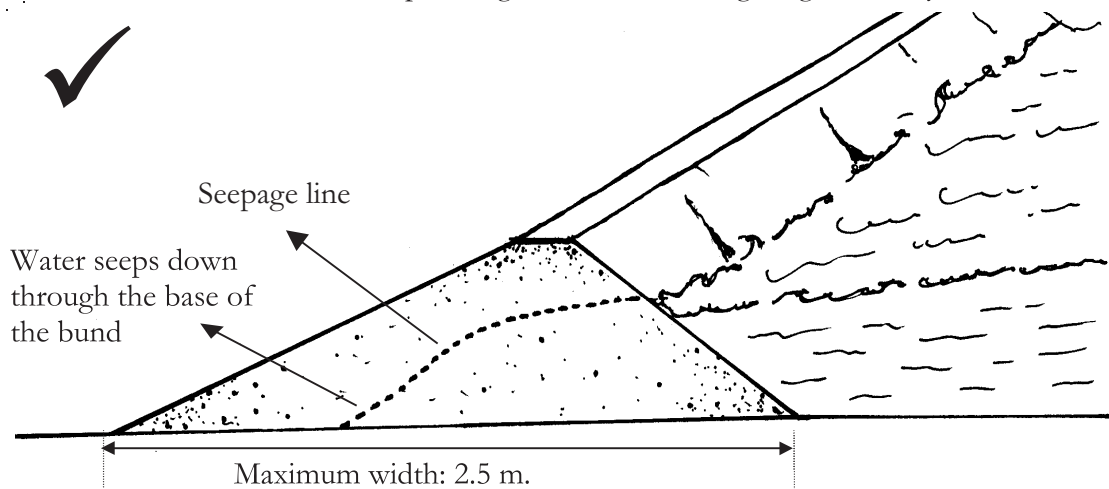

... in such cases, the downstream slope needs to be reduced so that the base can be widened. Water will then be unable to seep through the bund

Figure 13.7: Bunds made from clayey soils should have lower slopes

and out of the exit.

6. **Exit:** In black soils, exits can be provided in two ways, depending on local conditions:

- a) if the slope permits, a **channel should be dug upstream of the bund** for the exit of water. As opposed to permeable soils, this excavation should be done continuously. The water flowing out of each field should be given a channel, which uses the natural slopes to conduct water into the main drainage line. Grass should be planted on such channels in order to prevent soil erosion. At every 10-20 m. interval, small trenches should be dug across these channels which should be filled with stones. These trenches will prevent soil erosion, without obstructing the flow of water.
- b) **Where the Clayey Soil is underlain by Murram upto a Depth of 1 m:**

Here surplus water can be evacuated by yet another technique. Instead of providing for a drainage line outside the field, arrangements can be made for the water to percolate down below the field. Upstream of the bund and parallel to it, dig a trench 1 m. wide. The digging should be done until the mooram layer is encountered. Fill up this trench as follows (reverse filter):

- ▄ From the bottom, upto a height of 50 cm., fill up boulders.
- ▄ Above this layer of boulders, upto a height of 30 cm., pile up smaller boulders
- ▄ Above this, pile up coarse soil and gravel
- ▄ Top it up with coarse sand

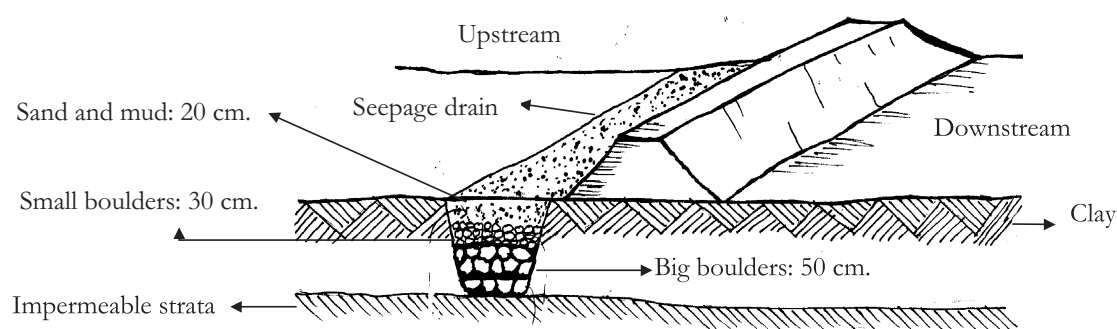

Where there is impermeable strata underneath clayey soils, a seepage drain can be constructed upstream of the bund for the percolation of water.

Figure 13.8: The reverse filter is an alternative way of evacuating surplus water

This trench will act in two ways:

- * The water that collects upstream of the bund will percolate below the ground through this trench
- * The permeable strata within the trench will absorb the moisture in the clayey soil around it, thus reducing the amount of water standing in the field.

How fast rain water flows in the field depends on:

- * the slope of the land
- * the permeability of the soil

That is, in highly sloping land and impermeable soil, water will flow more rapidly. In order to ensure safety and utility of the bund:

- ✓ Increase the downstream slope of the bund
- ✓ Decrease the distance between bunds
- ✓ Provide an exit in the bunds
- ✓ Give a gentle grade to the bunds too

14 | Dugout Farm Ponds

14.1 What is a Dugout Farm Pond (DOP)?

A DOP (also traditionally known in some parts of India as *dabri*) is a structure constructed on a farmer's land to harvest rainwater, which would otherwise have flowed out of the farm. On flatter land in the village, streams are not very deep, nor do they



have high embankments. Thus it becomes difficult to build water harvesting structures like earthen dams. In such flat lands, DOPs are the most effective water harvesting solution. The main objective of such structures is to provide protective irrigation to the kharif crop. In addition, in West Bengal, Assam, Chhatisgarh, Bihar, Jharkhand and Orissa, DOPs have been traditionally used to irrigate the rabi crop and also for fish farming.

14.2 Why is a DOP made?

The main reason for making a DOP is to collect rainwater, which would otherwise have flowed out of the field. There are several days in succession in the monsoon when there is no rainfall. Such prolonged dry spells may actually ruin the kharif crop. The DOP protects against such crop failure.

14.3 Site Selection

1. A DOP can be made on any and every field. The capacity of the DOP should be determined on the basis of the rainwater that is estimated to flow out of the farm
2. A DOP should be made in a farm or near it, so that protective irrigation can easily be given
3. The site where the DOP is built should not have a slope more than 2%. It has often been observed that wherever a DOP is made on higher slopes, its capacity is not fully utilised. This is because in such conditions, water tends to collect on one end of the DOP, while the other remains empty. This means that the storage will be less than proportionate to the cost of the DOP.
4. The catchment area of the site where the DOP is to be located should not be more than 5 ha.
5. The site should have an impermeable underground strata upto a depth of around 3 metres. Otherwise, the water collected in the DOP will immediately percolate down and no water will be available for protective irrigation, defeating the very purpose of the DOP.
6. In case there is a well on the farm, the DOP should be made upstream of it so that the well may benefit from recharge from the pond
7. If we want to provide 10 cm of protective irrigation to the crop over 1 hectare, we need 1000 cum of water. Volume of water required = Area to be irrigated x depth of irrigation = 1 hectare x 10 cm. = 10,000 sq.m. x 0.1m. = 1000 cum. A DOP whose dimensions are 25m x 20 m x 2.5 m will yield this amount of water. Such a DOP will occupy 25m. x 20m. = 500 sq.m. in 1 hectare, i.e., 5% of the area to be irrigated ($500/10,000 = 5\%$). That is why this is sometimes referred to as the **5% model**.
8. A DOP should generally be made only where there are no appropriate sites for construction of other water harvesting structures such as earthen dams. The cost of the DOP per cum of water harvested is higher than that of an earthen dam. This is because its storage of water is only in the excavated portion and not against an embankment as in an earthen dam.

14.4 How to make a DOP

1. select an appropriate site on the basis of the considerations outlined above
2. make the layout for the excavation of the DOP at the chosen site
3. leave a gap of about 2 to 3 m between the excavated portion and the mud piled up after excavation. This gap is known as a **berm**

4. if the mud excavated is fertile, spread it in the farm.

14.5 Special Precautions

1. Proper catchment area treatment should be done upstream of the DOP to reduce the rate of siltation within the DOP
2. A DOP is best made on first order or even smaller streams
3. A DOP should never be built on the main stream of the watershed
4. Farmers who do not have any other source of irrigation should be chosen as beneficiaries
5. For a given storage capacity, deeper DOPs are better than shallower ones since they occupy less of the farmer's land and are less prone to evaporation losses
6. However, making DOPs more than 3 m in depth increases the cost substantially
7. The base and sides of the exit should be pitched with stones. This ensures that there is no soil erosion when the water flows out of the exit

14.6 Planning a DOP

Before we plan a DOP, we need to estimate how much of the land we need to provide protective irrigation.

Question: If a farmer has 2 ha of land and all other factors are favourable, then how should a DOP be planned to ensure protective irrigation to the kharif crop?

Answer:

We know that the plot size is: 2 ha

$$\begin{aligned} \text{Now, } 1 \text{ ha} &= 100 \text{ m} \times 100 \text{ m} \\ &= 10,000 \text{ sqm} \end{aligned}$$

$$\text{Thus, } 2 \text{ ha} = 20,000 \text{ sq.m}$$

If in order to provide protective irrigation to the kharif crop, we need 10 cm (0.1 m) of water, then we need 2,000 cum of water for this:

$$20,000 \text{ sqm.} \times 0.1 \text{ m} = 2,000 \text{ cum}$$

The dimensions of this DOP could be varied. For instance, we could have a DOP with length 40 m \times breadth 20 m \times depth 2.5 m

15 | Estimation and Costing of Structures

One of the major concerns surrounding NREGA has been that rural public works programmes in India have had a long history of corruption. And that outlays on these programmes are very inadequately converted into concrete outcomes on the ground. Money spent does not result in creation of durable assets in the village. To address both these concerns it is very important to have a proper understanding of the Schedule of Rates that is used to estimate the cost of structures. Some of the most creative dimensions of corruption arise out of the way this schedule is used or abused by project implementers. At the same time, not using the schedule is also no option. That way we will have no grip on the productivity of work done or the utilisation of money spent. So what we need to do is to learn the ins and outs of this schedule so that we know how structures built under NREGA are to be costed. And to ensure that outlays are truly converted into outcomes. This is what we will do in this chapter. Of course, we also need to critically examine whether the way the present schedules have been devised make it possible for workers to earn minimum wages and for panchayats to carry out works within the rates prescribed. If not, the schedules need to be revised. All these issues will be dealt with in the next chapter

15.1 What is a Schedule of Rates?

Estimation of the financial cost of works undertaken is usually done on the basis of a Schedule of Rates (SoR) prepared by concerned departments of each state government. The SoR breaks up all work done to build any structure into a series of **tasks** and provides government approved rates for costing of each task. These are called **Task Rates**.

These task rates are for different types of work (buildings, bridges, roads, dams, irrigation canals, lift irrigation, water supply, sanitation and sewerage). The rates include labour rates (based on minimum wages), rates for materials used, rates for transportation of materials, hiring charges of machines and vehicles, royalty payments for "freely available natural resources" and rates for maintenance of structures. In this chapter, we will be mainly discussing labour rates for earthwork and excavation.

The SoR is used both for:

1. preparing cost estimates for proposed works; and

2. valuation of work already completed.

15.2 How do we use a Schedule of Rates?

15.2.1 Step 1: Break down each work into its component tasks

To use the SoR, we first need to break down any proposed work into a detailed list of all the tasks involved in it. For instance, let us take the construction of **earthen contour bunds**. We can break this work down into its various component tasks:

1. excavation of earth
2. construction of contour bunds with excavated material and
3. providing stone exits, which in turn involves,
 - * collection of stones (including transportation where stones are not locally available); and
 - * construction of exits with stones at appropriate places.

Similarly, construction of **loose boulder checks** involves the following tasks:

- * excavation of foundation
- * collection of stones (including transportation where stones are not locally available); and
- * stacking of boulders to form the boulder check

Construction of more complicated structures like **corewall type earthen dams** involves several tasks:

1. site clearance;
2. digging cutoff trench;
3. puddle-filling of trench;
4. construction of corewall;
5. raising outer embankment by laying earth, watering and compaction;
6. stone pitching;
7. construction of rock toe and sand filters;
8. slope cutting
9. excavation for exit weir;
10. stone pitching of exit weir; and
11. transportation of construction materials including water, clay and stones

15.2.2 Step 2: Calculate the physical quantities for each task (Estimation)

Next, we calculate the physical quantity of each type of task (explained in detail in this chapter for each structure). This is called “quantity estimation” or simply “estimation”.

15.2.3 Step 3: Multiply these physical quantities by the task rates given in the SoR (Costing)

These quantities are then multiplied by their respective rates to get the cost of that work. The SoR gives rates per unit of work done for each task. This is called “costing”.

Quantity estimation and costing are necessary at various stages:

1. for financial budgeting, while planning the construction;
2. for monitoring, while the work is in progress; and
3. for valuation, after completion of construction.

The SoR provides rates per unit of each task (for example, rate for 1 cubic metre excavation in hard soil). After estimating the physical quantities of each task, these are multiplied by their task rates given in the SoR to get the cost of that task.

$$\text{Cost of Task} = \text{Physical Quantity of Task (cum)} \times \text{Task Rate (Rs/cum)}$$

15.2.4 Step 4: Sum Up Costs of all Tasks

This process is repeated for all tasks involved in completing a particular work. The total cost of construction is calculated by adding the costs of all tasks. Total Cost of Construction of (say) a contour trench = Sum of Costs of all Tasks

15.3 What an SoR Contains

In principle, the task rate is supposed to be arrived at by conducting a series of what are called "time and motion studies" that help estimate the amount of time involved in completing a task. The rates vary according to the nature of the work, the material worked upon and the implements used. Rates for different work on the same strata are different. The rates for same activity in different strata are also different. There are extra rates for additional tasks like

1. picking up excavated material from a depth ("lift");
2. carrying excavated materials for disposal ("lead");
3. transportation of materials which are not locally available (also called "lead");

4. work under adverse circumstances like excavation in standing water ("wet excavation")

The SoR also provides a higher rate for tasks which take up more time. For instance, the rate per cum for construction of a puddled clay corewall is higher than that of hearting with wetted clay in an earthen dam. Stone pitching is an activity, which requires a lot of care and precision. Hence, the rate provided is higher. Clearly, there is an attempt in the SoR to vary the rates of work in proportion to the arduousness of the task.

Table 1 gives a list of some typical rates commonly used in watershed programmes. These are taken from the Combined Schedule of Rates of Rural Engineering Service, GoMP.¹ The SoR gives the Item Number associated with each task followed by a detailed description of the task and the rate (Rs/cum) of this task. For this table we have shortened the descriptions given in the SoR. For instance, the detailed description of Item no. 301 (a) reads, "Excavation in Soft or Ordinary Soil including 50m lead and 1.5m lift with dressing".

Table 15.1
Rates Commonly Used in Watershed Projects

Item No.	Description	Rate
I	Excavation and Earthwork	Rs/Cum
301(a)	Soft Soil	17.90
301(b)	Hard Soil	23.20
301(c)	Hard Mooram	30.70
302(a)	Disintegrated Rock	77.10
302(b)	Hard Rock Requiring Blasting	98.40
302(c)	Hard Rock Requiring where Blasting is Prohibited	162.90
101	Site clearance in sqm	0.60
II	Special Rates for Earthen Structures	
2305	Puddle clay mixing& Watering	104
2306	Puddle Filling with Good Clay	54.20
	Construction of Embankment with:	
303(b)	i. Hard Soil	28.30
303(c)	ii. Hard Mooram	31.90
303(d)	iii. Disintegrated Rock	86.70
1807	Collection of Boulders and Stacking	39.20
2310	Rock Pitching on the Upstream Face of the Embankment By Boulders	122.90
2309	Horizontal filter with 40mm Boulder size	188.40
2309	Construction of Rock Toe Filter	124.65

¹ The SoRs for each state and each department will vary in different ways but they all broadly follow this kind of pattern

Item No.	Description	Rate
413	Extra Rate for Wet Excavation	10%
1810-A	Collection of Stone for Masonry Work for Items other than Basalt & Granite	151.1
1810-B	Collection of Stone for masonry work for Basalt & Granite	166.2
1801	Collection of Clay for Puddling	32.2
III	Rates for Cement Structures	
401	Backfilling Behind Foundation etc with soil (Lab Only)	12.8
402	Backfilling Behind Foundation etc with HM	51.8
404	Sand filling Below floors/Foundations etc.	51.3
408	Lime concrete in Foundation (lime : sand)	
	a. Lime Mortar 1:2	594.6
	b. Lime Mortar 1:3	564.6
413	PCC for foundation with 40mm metal size (cement : sand : metal)	
a	1:02:04	1309.6
b	1:03:06	984.9
c	1:04:08	839.3
d	1:05:10	722.8
416 a.	Add to item no 413 if metal size is 20mm	75.2
416 b.	Add to item no 413 if metal size is 12mm	78
425 c.	RCC 1:2:4 excluding cost of steel	1419.8
506	Random rubble Masonry (cement : sand)	
c	1:4	849.9
d	1:5	780.6
e	1:6	721.2
f	1:8	642
IV	Transportation of Materials	
1902(1)	Metal (1km)	39.30
1902(2)	Metal (2km)	44.70
19043	Boulders (1km)	45.20
1904(3)	Boulders (2km)	51.41
1904(4)	Puddle Earth (1km)	35.37
1904(4)	Puddle Earth (2km)	40.23
1901-b	Water for Puddle Work (0.2 km)	1.10
1901-a	Water for Earthwork (0.2 km)	0.80
1901-c	Water for Cement work (0.2 km)	4.4

Source: Combined Schedule of Rates of Rural Engineering Service, GoMP, 2003

15.4 Precautions While Using SoRs

While using the SoR, a few precautions should be taken:

1. The strata on which the rate is applied should conform to the classification in the SoR. There is a detailed description of each stratum in the SoR. For instance,

disintegrated rock (DR) in the above table refers to "such strata which require close application of crowbars, picks, grafting tools and scarifiers, in suitable combination, for its excavation, such as soft laterite, soft conglomerate, hard shale, soft copra, hard and compacted moorum mixed with small boulders exceeding 25% in quantity but each not exceeding 0.014 cum in size". The rate of DR is higher than that for softer strata. It must, therefore, be ensured that the use of this rate is justified by the hardness of the strata.

2. Avoid duplication in the use of rates. For instance, the rate for excavation on hard soils (Item no. 301-b) is Rs. 23.20/cum, whereas the rate for construction of embankment with hard soils (Item no. 303-b) is Rs. 28.30/cum. It would be wrong to apply this rate twice, once on excavation of material and then on volume of embankment raised as *the cost of construction of embankment includes cost of excavation of material*. Thus, Rs. 23.20 in Item no. 303-b is for excavation of hard soils and Rs. 5.10 (28.30 less 23.20) is for construction of embankment.
3. The SoR provides no rates for certain items like placing plastic sheet in an underground dyke or chainlink wire in gabion structures. Such items should be costed on the basis of actual market prices.
4. In all estimates and valuations, the name of the SoR, place and year of publication, item number of the rate used and detailed description of the task should always be mentioned. This ensures cross-checking and transparency.
5. No extra rates should be applied for providing settlement allowance. The rate given for construction of earthen bunds and dams is inclusive of cost of raising the bund or dam to extra height on account of settlement allowance.
6. No extra rate is allowed for removing "dead-men" or "tell-tales". While excavating earth, certain portions are left unexcavated as evidence of the situation before work started. For instance, when constructing a dugout pond, the unexcavated portions reveal the lay of the ground before work started and hence the depth to which excavation has been done. Such evidence is necessary for conducting valuation of the structure. After final measurements, these portions are removed. The rate for this work includes this cost also and should not be separately charged.
7. Rates related to lift only apply after crossing the threshold of the initial free lift (usually 1.5 metres). Similarly, rates for lead apply after crossing the threshold of the initial free lead (usually 50 metres). The quantities of free lift and lead should be deducted from the total lift and lead while applying the rate.

15.5 Some Useful Formulae in Computing Areas and Volumes

Quantity of work is calculated with the help of the physical dimensions (length, width and height or depth) of the proposed construction. For computing the quantities, volume of different shapes are to be calculated. **Some of basic formulae required for computing the area and volumes of different shapes are as follows:**

1. Area of a Square

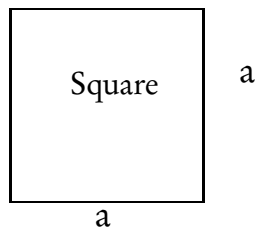

$$\begin{aligned} \text{area} &= (\text{length of sides})^2 \\ &= a^2 \end{aligned}$$

2. Area of a Rectangle

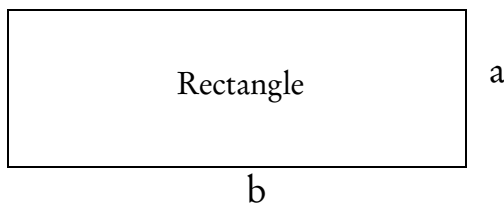

$$\begin{aligned} \text{area} &= \text{length} \times \text{width} \\ &= a \times b \end{aligned}$$

3. Trapezoid

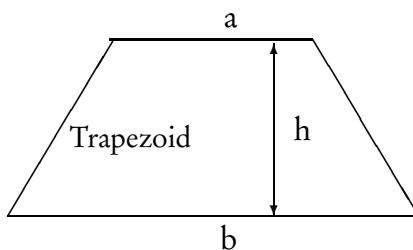

$$\begin{aligned} \text{area} &= \text{average of sides of trapezoid} \times \\ &\quad \text{distance between the two sides} \\ &= \left\{ \frac{1}{2} \times (a + b) \right\} \times h \end{aligned}$$

4. Right Angled Triangle

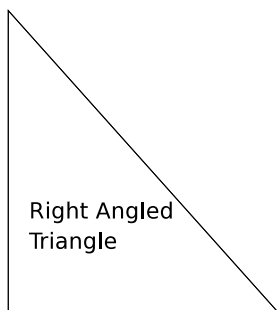

$$\begin{aligned} \text{area} &= \frac{1}{2} \times \text{base} \times \text{height} \\ &= \frac{1}{2} \times b \times h \end{aligned}$$

5. Circle

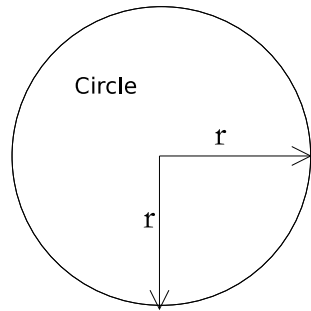

$$\begin{aligned} \text{area} &= \frac{22}{7} \times (\text{radius})^2 \\ &= \frac{22}{7} \times r^2 \end{aligned}$$

$$\begin{aligned} \text{Circumference of a circle} &= 2 \times \frac{22}{7} \times \text{radius} \\ &= 2 \times \frac{22}{7} \times r \end{aligned}$$

6. Volume

$$\text{Volume} = \text{Cross section area} \times \text{Length}$$

7. Pythagoras Theorem

Pythagoras Theorem is very useful in calculating slopes and deriving the length of slope in a right angle triangle. As is clear from the figure, one angle of a right triangle (or right angled triangle) is always 90° .

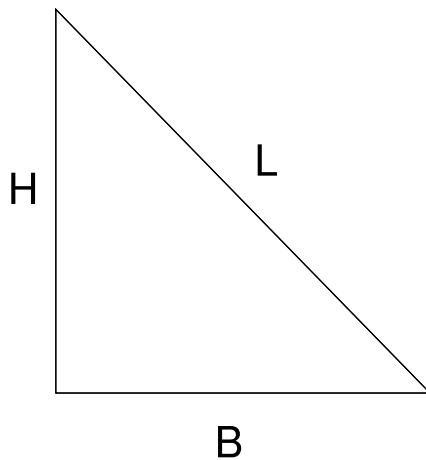

$$\text{hypotenuse} = L$$

$$\text{base} = B$$

$$\text{perpendicular} = H$$

By the Pythagoras theorem:

$$(\text{hypotenuse})^2 = (\text{base})^2 + (\text{perpendicular})^2$$

$$\text{or } L^2 = B^2 + H^2$$

$$\text{or } L = \sqrt{B^2 + H^2}$$

$$\therefore \text{hypotenuse} = \sqrt{(\text{base})^2 + (\text{perpendicular})^2}$$

Some important consequences follow from the Pythagoras Theorem. For example, in the following diagram:

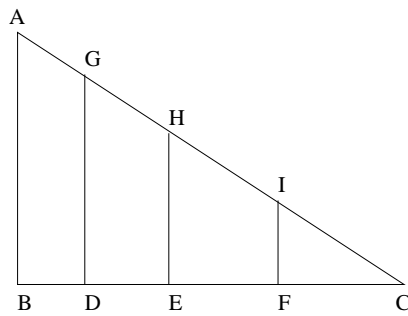

$$\frac{AB}{BC} = \frac{GD}{CD} = \frac{HE}{EC} = \frac{IF}{CF}$$

It is this principle that is used in levelling instruments, to calculate the horizontal distance between objects, elevations on ground and in marking contours.

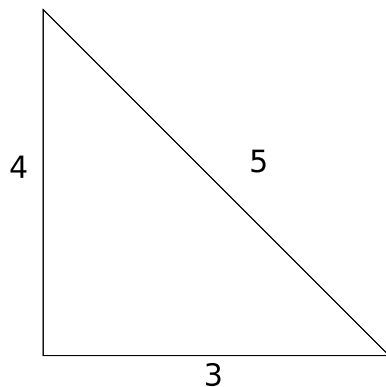

The Pythagoras Theorem can also be used to mark right angle on ground in a layout. Select a corner where the right angle has to be made. Mark out 3m on one arm and 4 m on the other arm. Measure the length of the hypotenuse. If it is 5 m, then the angle is a perfect right angle.

15.6 Estimation of Quantity of Work

For estimating the quantity of work, structures are classified into four groups on the basis of their cross-section area and type of material used.

Table 15.3

Classification of Structures on the Basis of Material and Cross-section

		Type of Material	
		Homogeneous	Heterogeneous
Cross Section Area	Uniform	Group I (Contour Trenches & Contour Bunds in One Type of Strata)	Group II (Contour Trenches & Contour Bunds in Different Types of Strata)
	Variable	Group III (Boulder Check, Gabion Structure, Homogeneous Earthen Dam)	Group IV (Corewall Type Earthen Dam, Hearting/Casing type Earthen Dam)

- * **Group I:** Uniform cross-section area and homogeneous material. Examples: Contour Trenches, Contour Bunds and Farm Bunding in same type of strata.
- * **Group II:** Uniform cross-section area and heterogeneous material. Examples: Contour Trenches, Contour Bunds and Farm Bunding in different types of soil.

- * **Group III:** Variable cross-section and homogeneous material. Examples: Boulder Check, Gabion Structure and Homogeneous Earthen Dam.
- * **Group IV:** Variable cross-section and heterogeneous material. Corewall type and Hearting/Casing type earthen dam.

We will discuss quantity estimation and costing of each of these groups in the following sections, with some numerical examples.

15.6.1 Group I Structures

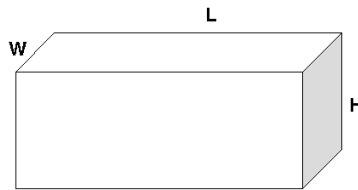

When the cross-section is similar throughout the length and material is also same, we can calculate the quantities by the formula:

$$\text{Volume } (V) = \text{Length } (L) \times \text{Width } (W) \times \text{Height (or Depth)} (H)$$

$$V = L \times W \times H$$

$$\begin{aligned} \text{and Cost of Work} &= \text{Volume} \times \text{Unit Rate } (R) \text{ per volume of work} \\ &= V \times R \end{aligned}$$

15.6.2 Group II Structures

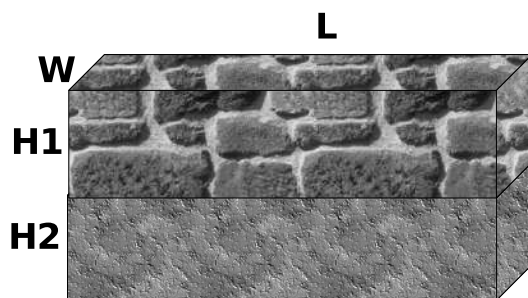

In these types of structures, the cross-section area is uniform throughout the length of the structure, but material varies. We have to calculate the quantities of various types of materials separately, as the unit rates for different strata are different. Take, for instance, a contour

trench with two layers, the upper one and the lower one.

$$\text{Volume of Upper Layer } V_1 = \text{Length} \times \text{Width} \times \text{Depth of Soft Soil Strata}$$

$$\text{or, } V_1 = L \times W \times H_1$$

$$\text{Volume of Lower Layer } V_2 = \text{Length} \times \text{Width} \times \text{Depth of Hard Soil}$$

$$\text{or, } V_2 = L \times W \times H_2$$

$$\therefore \text{Total Volume} = V_1 + V_2$$

Assuming that the rate for digging in soft soil = R_1

and the rate for digging in hard soil = R_2

then, cost of work for upper layer $C_1 = V_1 \times R_1$

and, cost of work for lower layer $C_2 = V_2 \times R_2$

\therefore Total Cost, $C = C_1 + C_2$

15.6.3 Group III Structures

This group of structures has homogeneous construction material but their cross-section area varies across the length of the structure. Here, the structure is divided into several sections and volume of each section is worked out. These volumes are then summed to get the total volume of the structure. The total volume is multiplied by the rate for that particular stratum to derive the total cost.

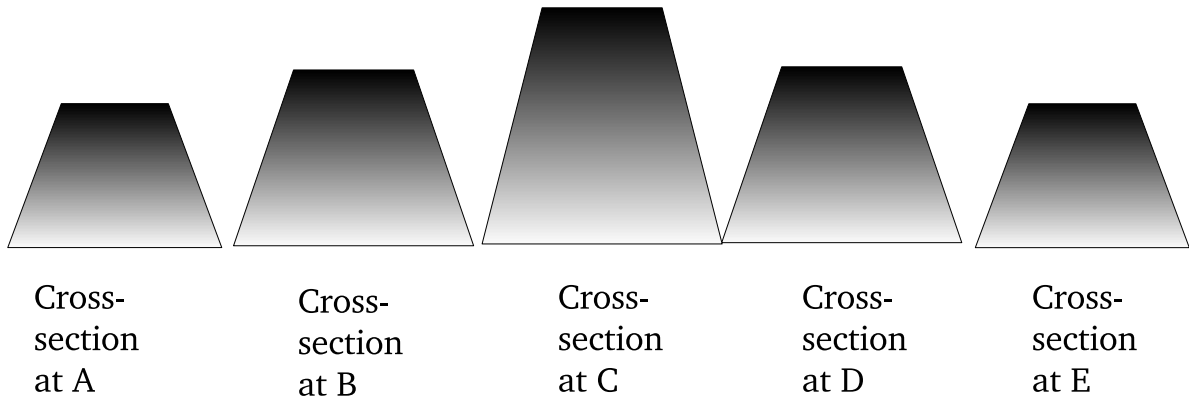

*Total volume of work = Volume of work of Section A to B
+ Volume of work of Section B to C
+ Volume of work of Section C to D + ...*

The volume of work of a section is arrived at by averaging the cross section areas of two ends of the section and then multiplying it with the length of that section:

$$\text{Volume A to B, } V_1 = \frac{(\text{Cross section area at A} + \text{Cross section area at B})}{2} \times \text{Length AB}$$

$$\text{Volume B to C, } V_2 = \frac{(\text{Cross section area at B} + \text{Cross section area at C})}{2} \times \text{Length BC}$$

$$\text{Volume C to D, } V_3 = \frac{(\text{Cross section area at C} + \text{Cross section area at D})}{2} \times \text{Length CD}$$

$$\text{Volume D to E, } V_4 = \frac{(\text{Cross section area at D} + \text{Cross section area at E})}{2} \times \text{Length DE}$$

Total Volume of Work, $V = V_1 + V_2 + V_3 + V_4 + \dots$

As the material used is the same throughout,

$$\text{Total Cost of Work} = V \times R$$

15.6.4 Group IV Structures

In this group, structures have variable cross section area along their length and are also made of heterogeneous construction material. Hence, we have to:

1. Calculate cross section area (C1, C2 etc.) for each material (for instance, top soil) at each point;
2. Calculate average cross section areas of each material;
3. Multiply this average area with the length between two points to get the volume of the material in that section;
4. Repeat this for all materials and all sections;
5. Sum up all volumes of a particular material;
6. Repeat this for all materials; and
7. Multiply volume for each material with its unit rate to get the total cost of work.

If the unit-rates for work with different types of material are $R_1, R_2, R_3 \dots$, then:

$$\text{Total Cost of Work} = V_1 \times R_1 + V_2 \times R_2 + V_3 \times R_3 + \dots \text{ etc.}$$

15.7 Some Examples of Quantity Estimation and Costing for Watershed Structures

Example 1: Continuous Contour Trenches (CCT) in Homogeneous Material

An NGO working in Mandasaur district of MP plans to construct CCT in hard soil in a 20 hectare catchment. The distance between two successive rows of CCT is 20 metres. The width and depth of the CCT is 50 cm x 50 cm. Calculate the cost of construction of CCT.

Solution

Step 1 ■ Calculation of volume of work in 1 hectare

To make the calculation simple, we will first carry out the calculation for a 1 ha catchment. We assume that the hectare area is square-shaped with sides of 100m length.

$$\begin{aligned} \text{Length of CCT per ha} &= \frac{\text{Cross section area}}{\text{Distance between two rows of trench}} \\ &= \frac{10,000 \text{ sqm}}{20 \text{ m}} = 500 \text{ m} \end{aligned}$$

$$\begin{aligned} \text{Cross section area of CCT} &= \text{Width} \times \text{Depth} \\ &= 0.50 \text{ m} \times 0.50 \text{ m} = 0.25 \text{ sqm} \end{aligned}$$

$$\begin{aligned} \text{Volume of work in 1 ha} &= \text{Area of cross section} \times \text{Length} \\ &= 0.25 \text{ sqm} \times 500 \text{ m} \\ &= 125 \text{ cum} \end{aligned}$$

Step 2 ■ Calculation of cost of CCT in 1 hectare

$$\begin{aligned} \text{Cost of CCT in 1 ha} &= \text{Volume of work (cum)} \\ &\quad \times \text{Rate of Excavation in Hard Soil (Rs/cum)} \\ &= 125 \times 23.20 \\ &= \text{Rs. 2,900} \end{aligned}$$

Step 3 ■ Total Cost

On the basis of the above calculations,

$$\begin{aligned} \text{Total cost of CCT for 20 ha} &= 20 \times \text{Cost of CCT in 1 ha} \\ &= 20 \times 2,900 \\ &= \text{Rs. 58,000} \end{aligned}$$

Example 2: Continuous Contour Trenches (CCT) in Heterogeneous Material

Department of Agriculture in Gaya District, Bihar proposes to make CCT in a catchment area of 40 hectares. The top **soft soil** stratum has a depth of 30 cm followed by **hard soil** for about 1 metre. The horizontal spacing between two successive rows CCT is 25 m. The width and depth of the CCT is 50 cm x 50 cm. Calculate the cost of construction of CCT.

Solution

Step 1 ■ Calculation of volume of work in 1 hectare

$$\begin{aligned} \text{Length of CCT per ha} &= \frac{\text{Cross section area}}{\text{Distance between two rows of trench}} \\ &= \frac{10,000 \text{ sqm}}{25 \text{ m}} = 400 \text{ m} \end{aligned}$$

Step 2 ■ Cost of work in soft soil

Since the material is heterogeneous (Group II Structure), we have to calculate the

volumes of soft soil excavation and hard soil excavation separately.

$$\begin{aligned} \text{Cross section area in soft soil} &= \text{Width} \times \text{Depth of soft soil} \\ &= 0.50 \text{ m} \times 0.30 \text{ m} \\ &= 0.15 \text{ sqm} \end{aligned}$$

$$\begin{aligned} \text{Volume of trench in soft soil} &= \text{Area of cross section} \times \text{Length} \\ &= 0.15 \text{ sqm} \times 400 \text{ m} \\ &= 60 \text{ cum} \end{aligned}$$

$$\text{Rate of digging in soft soil} = \text{Rs. } 17.90 \text{ per cum}$$

$$\begin{aligned} \text{Cost in soft soil} &= 60 \times 17.90 \\ &= \text{Rs. } 1,074 \end{aligned}$$

Step 3 ■ Cost of work in hard soil

$$\begin{aligned} \text{Cross section area in hard soil} &= \text{Width} \times \text{Depth of hard soil} \\ &= 0.50 \text{ m} \times 0.20 \text{ m} \\ &= 0.10 \text{ sqm} \end{aligned}$$

$$\begin{aligned} \text{Volume of trench in hard soil} &= \text{Area of cross section} \times \text{Length} \\ &= 0.10 \text{ sqm} \times 400 \text{ m} \\ &= 40 \text{ cum} \end{aligned}$$

$$\text{Rate of digging in hard soil} = \text{Rs. } 23.20 \text{ per cum}$$

$$\begin{aligned} \text{Cost in soft soil} &= 40 \times 23.20 \\ &= \text{Rs. } 928 \end{aligned}$$

Step 4 ■ Total Cost

$$\begin{aligned} \text{Cost per ha of CCT} &= 1074 + 928 \\ &= \text{Rs. } 2002 \end{aligned}$$

$$\text{Total catchment area} = 40 \text{ ha}$$

$$\begin{aligned} \text{Thus, total cost for } 40 \text{ ha} &= 40 \times 2002 \\ &= \text{Rs. } 80,080 \end{aligned}$$

We can now prepare a cost sheet like the one below:

Cost Sheet for Continuous Contour Trenches (Heterogeneous Material)

	Particulars of work	Unit	Volume/Area	Rate/Unit (Rs.)	Amount (Rs.)
1	Excavation in Soft Soil in 1 ha	Cum	60	17.90	1,074
2	Excavation in Hard Soil in 1 ha	Cum	40	23.20	928
3	Cost of CCT in 1 ha	Rs.			2,002
4	Total Catchment Area	Ha	40		
5	Total Cost of CCT	Rs.			80,080

Example 3: Staggered Contour Trenches (SCT) in Heterogeneous Material

Question: The DRDA of Ambikapur District, Chhattisgarh, proposes to make SCT in a catchment of 35 ha. The row-to-row spacing for contour trenches is 10 metres and the spacing between two trenches within a row is 3 metres. The dimensions of the trench are 5m x 50cm x 50 cm. Calculate the cost of SCT. The work will be done in Soft Soil – 20% and Hard Soil – 80%

Solution**Step 1 ■ Calculation of volume of work in 1 hectare**

$$\begin{aligned} \text{Length of SCT per ha} &= \frac{\text{Cross section area}}{\text{Distance between two rows of trench}} \\ &= \frac{10,000 \text{ sqm}}{10 \text{ m}} = 1,000 \text{ m} \end{aligned}$$

$$\text{Length of one trench} = 5 \text{ m}$$

$$\text{Gap between two trenches} = 3 \text{ m}$$

$$\text{Effective length of one trench} = 5 + 3 = 8 \text{ m}$$

$$\begin{aligned} \text{No. of trenches over 1 ha} &= \frac{\text{Length of SCT}}{\text{Effective length of 1 trench}} \\ &= \frac{1,000}{8} = 125 \text{ trenches} \end{aligned}$$

$$\begin{aligned} \text{Cross section area of trench} &= \text{Width} \times \text{Depth of trench} \\ &= 0.50 \text{ m} \times 0.50 \text{ m} = 0.25 \text{ sqm} \end{aligned}$$

$$\begin{aligned} \text{Volume of trench} &= \text{Area of cross section} \times \text{Length of trench} \\ &= 0.25 \text{ sqm} \times 5 \text{ m} = 1.25 \text{ cum} \end{aligned}$$

Total volume of 125 trenches in 1 ha = No. of trenches \times Volume of 1 trench

$$= 125 \times 1.25 = 156 \text{ cum}$$

$$\text{Volume in soft soil @20\%} = 156 \times \frac{20}{100} = 31 \text{ cum}$$

$$\text{Volume in hard soil @80\%} = 156 \times \frac{80}{100} = 125 \text{ cum}$$

Step 2 ■ Total Cost

Cost Sheet for Continuous Contour Trenches (Heterogeneous Material)

	Particulars of work	Unit	Volume/ Area	Rate/Unit (Rs.)	Amount (Rs.)
1	Excavation in Soft Soil (in 1 ha)	Cum	31	17.9	554.9
2	Excavation in Hard Soil (in 1 ha)	cum	125	23.2	2,900
3	Cost of CCT in 1 ha	Rs.			3,454.9
4	Total Area of SCT	ha	35		
5	Total Cost of SCT	Rs.			1,20,922

Example 4: Contour Bunds in Homogeneous Material

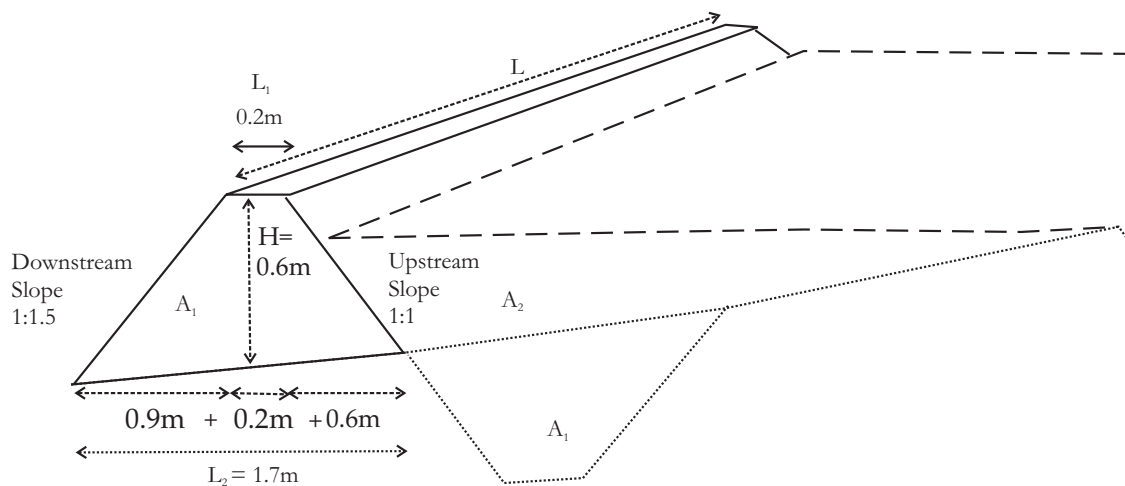

L = Length of the Contour Bund

L_1 = Top Width

L_2 = Base Width

A_1 = Cross Sectional Area of the Contour Bund

A_2 = Cross Sectional Area of Water standing against the Bund

h = Height of the bund

As part of the CAPART Watershed Programme, an NGO in Shajapur district of MP has proposed construction of Contour Bunds (CB). Calculate the cost of work when the details are as follows (see also figure above):

1. Height of bund: 0.60 metres
2. Proposed catchment area: 40 hectares
3. Top width: 0.20 metres.
4. Upstream slope: 1:1
5. Downstream slope: 1:1.5
6. Horizontal distance between CB rows: 33 metres.

Solution

Step 1 ■ Planning for 1 hectare

We assume this 1 ha plot approximates a square.

$$\text{Horizontal distance between 2 CB rows} = 33 \text{ m}$$

$$\text{Thus, length of CBs in 1 ha} = \frac{10,000 \text{ sqm}}{33 \text{ m}} = 300 \text{ m}$$

The cross section of the CB is in the shape of a trapezium. Since the height is uniform, the cross section area remains uniform throughout the length of the CB. Thus,

$$\begin{aligned} \text{Area of a trapezoid} &= \text{Average of length of parallel sides} \times \text{Distance between two parallel sides} \\ &= \frac{1}{2} \times (\text{Top width} + \text{Bottom width}) \times \text{Height} \end{aligned}$$

We know the height and top width. Let us calculate the bottom width. Since the d/s slope is 1:1.5, the base of the d/s triangle will be:

$$\begin{aligned} \text{Base width of d/s triangle} &= \text{Height} \times 1.5 \\ &= 0.60 \text{ m} \times 1.5 = 0.90 \text{ m} \end{aligned}$$

Since the u/s slope is 1:1,

$$\begin{aligned} \text{Base width of u/s triangle} &= \text{Height} \times 1 \\ &= 0.60 \text{ m} \times 1 = 0.60 \text{ m} \end{aligned}$$

$$\text{Top width} = 0.20 \text{ m.}$$

$$\begin{aligned} \text{Thus bottom width} &= \text{base of the u/s triangle} \\ &+ \text{base of the d/s triangle} + \text{top width} \\ &= 0.60 + 0.90 + 0.20 = 1.70 \text{ m} \end{aligned}$$

$$\begin{aligned} \text{Thus, the cross section area of bund} &= \frac{1}{2} \times (0.20 + 1.70) \times 0.60 \\ &= 0.57 \text{ sqm} \end{aligned}$$

$$\begin{aligned}
 \text{Volume of excavation of CBs in 1 ha} &= \text{Area of cross section} \times \text{Length} \\
 &= 0.57 \text{ sqm} \times 300 \text{ m} \\
 &= 171 \text{ cum}
 \end{aligned}$$

Step 2 ■ Total Cost

Cost Sheet for Contour Bunds in Homogeneous Material

	Particulars of work	Unit	Volume/ Area	Rate/Unit (Rs.)	Amount (Rs.)
1	Excavation in Hard Soil (in 1 ha)	cum	171	28.30	4,839
2	Total Catchment Area	Ha	40		
3	Total Cost of CBs in 40 ha	Rs.			1,93,572

Example 5: Contour Bunding in Heterogeneous Material

Find out the cost of the CB of the following cross-section, to be made in Khandwa district of MP. The area to be treated is 65 ha. The horizontal distance between two CB rows is 50 metres.

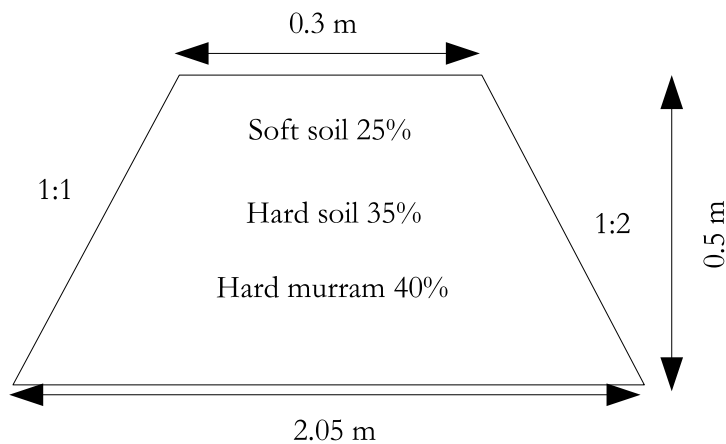

Solution

Step 1 ■ We first make the plan for 1 hectare

We assume the 1 ha plot approximates a square.

$$\begin{aligned}
 \text{Thus, length of CBs in 1 ha} &= \frac{\text{area}}{\text{Horizontal distance between rows of CBs}} \\
 &= \frac{10,000 \text{ sqm}}{50 \text{ m}} = 200 \text{ m}
 \end{aligned}$$

The cross section of the CB is in the shape of a trapezium. Since the height is uniform,

the cross section area remains uniform throughout the length of the CB

Area of a trapezoid = Average length of parallel sides × Distance between two parallel sides

$$= \frac{1}{2} \times (\text{Top width} + \text{Bottom width}) \times \text{Height}$$

We know the height and top width. Let us calculate the bottom width. Since the d/s slope is 1:2, the base of the d/s triangle will be:

$$\begin{aligned} \text{Base width of d/s triangle} &= \text{Height} \times 2 \\ &= 0.50 \text{ m} \times 2 = 1 \text{ m} \end{aligned}$$

Since the u/s slope is 1:1.5,

$$\begin{aligned} \text{Base width of u/s triangle} &= \text{Height} \times 1.5 \\ &= 0.50 \text{ m} \times 1.5 = 0.75 \text{ m} \end{aligned}$$

$$\text{Top width} = 0.30 \text{ m.}$$

$$\begin{aligned} \text{Thus bottom width} &= \text{base of the u/s triangle} \\ &+ \text{base of the d/s triangle} + \text{top width} \\ &= 1.00 + 0.75 + 0.30 = 2.05 \text{ m} \end{aligned}$$

$$\begin{aligned} \text{Thus, the cross section area of bund} &= \frac{1}{2} \times (0.30 + 2.05) \times 0.50 \\ &= 0.59 \text{ sqm} \end{aligned}$$

$$\begin{aligned} \text{Volume of excavation of CBs in 1 ha} &= \text{Area of cross section} \times \text{Length} \\ &= 0.59 \text{ sqm} \times 200 \text{ m} = 118 \text{ cum} \end{aligned}$$

$$\text{Volume of Soft Soil @25\%} = 118 \times 25\% = 29.5 \text{ cum}$$

$$\text{Volume of Hard Soil @35\%} = 118 \times 35\% = 41.3 \text{ cum}$$

$$\text{Volume of Hard Mooram @40\%} = 118 \times 40\% = 47.2 \text{ cum}$$

Step 2 ■ Total Cost

Cost Sheet for Contour Bunds in Heterogeneous Material

	Particulars	Unit	Volume/Area	Rate/Unit (Rs.)	Amount (Rs.)
1	Excavation in Soft Soil (in 1 ha)	cum	29.50	23.00	679
2	Excavation in Hard Soil (in 1 ha)	cum	41.30	28.30	1,169
3	Excavation in Hard Mooram (in 1 ha)	cum	47.20	31.89	1,505
3	Cost of CB in 1ha	Rs.			3,352
4	Total Catchment area	ha	65		
5	Total Cost of CB	Rs.			2,17,912

Example 6: Loose Boulder Checks (LBC) in Homogeneous Material with Variable Cross Section

Samaj Pragati Sahayog is planning to construct 210 LBCs of the following cross section in Kanad Watershed, Dewas District, Madhya Pradesh. The heights at different points on the LBC are given in the table below. Estimate the total cost of making 210 LBCs.

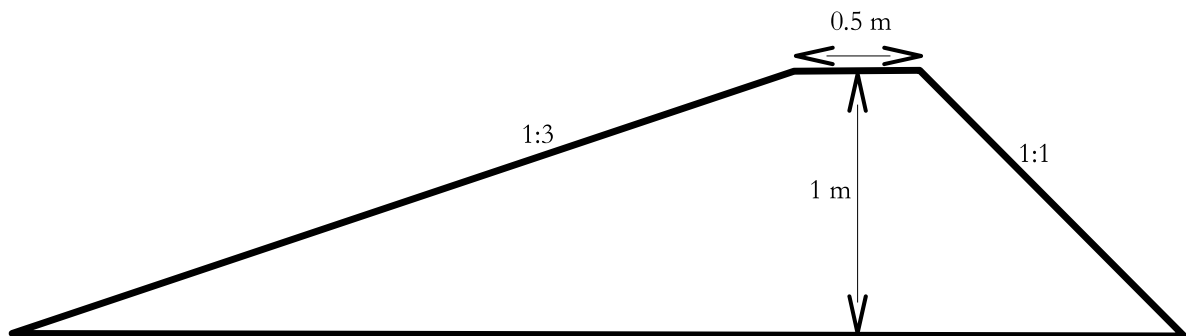

Points	Chainage (m)	Height (h)
A	0	0
B	2	0.7
C	5	1
D	9	0.5
E	11	0

Solution

The height of an LBC and hence its cross section area varies at different points of the LBC. The above table shows the height and chainage of the LBC at different points A, B, C ... etc. measured from one end of the naala to the other end. **Chainage** is a term that refers to the distance of that point from the end of the naala from where we start marking points. We need to calculate the cross-section area of the LBC at each of these points.

The cross-section of an LBC has a trapezoidal shape.

Area of a trapezium = Average of parallel sides × Distance between two parallel sides

$$= \frac{(a + b)}{2} \times h,$$

where, a = Top width, b = Base width, h = Height

Base width = Upstream Slope × Height

+ Downstream Slope × Height

+ Top width

$$\begin{aligned}
 &= (1 + 3) \times h + a = 4h + a \\
 \text{Cross section of LBC} &= \frac{(\text{Top Width} + \text{Bottom Width})}{2} \times \text{Height} \\
 &= \frac{(4h + a + a)}{2} \times h = \frac{(4h + 2a)}{2} \times h \\
 &= (2h + a) \times h \\
 &= 2h^2 + ah
 \end{aligned}$$

Using this formula, the cross section areas for various points along the LBC can be arrived at. Then we need to multiply these with the distance between successive points to get the volume of sections between each pair of points:

$$\begin{aligned}
 \text{Distance between point A and B} &= \text{Chainage at Point B} - \text{Chainage at Point A} \\
 &= 2 - 0 = 2 \text{ m}
 \end{aligned}$$

$$\begin{aligned}
 \text{Distance between point B and C} &= \text{Chainage at Point C} - \text{Chainage at Point B} \\
 &= 5 - 2 = 3 \text{ m} \dots \text{ etc}
 \end{aligned}$$

Cost Sheet for Loose Boulder Checks (Homogeneous Material)

Points	Chainage (in m)	Height (h) (in m)	Area of Cross section (=2h ² + ah) (sqm)	Average area of Cross Section (in sqm)	Distance (m)	Volume (cum)
A	0	0	0	0	0	0
B	2	0.7	1.33	0.67	2	1.33
C	5	1	2.5	1.92	3	5.76
D	9	0.5	0.75	1.63	4	6.52
E	11	0	0	0.37	2	0.74
Volume of Boulder Check						14.36
Add 15% of total volume for the exit of LBC						2.15
Total Volume of LBC						16.52
Unit Rate for collection & stacking of boulders (Rs.)						39.20
Unit Cost of Boulder Check (16.52 x 39.20) (Rs.)						648.00
Total No. of LBC						210
Total Cost of LBC (648 x 210) (Rs.)						1,36,080

Example 7: Dugout Pond

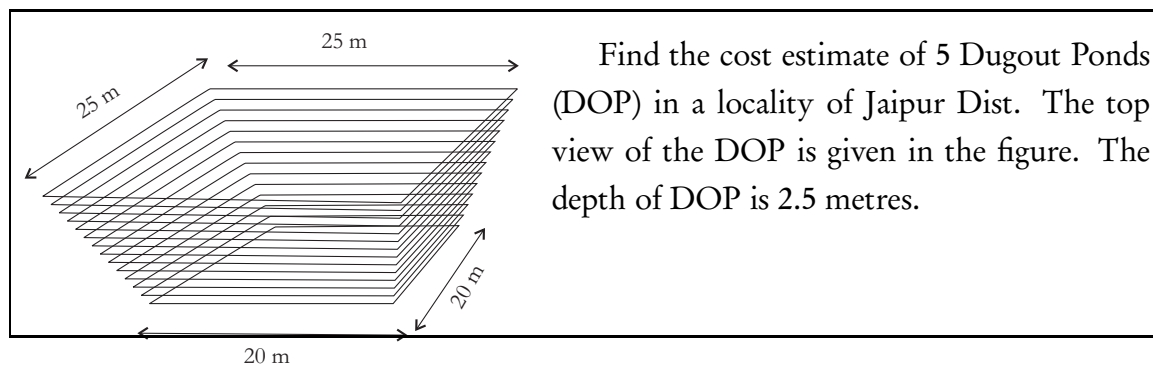

Solution

The DOP has a rectangular shape. However, the areas of its top and bottom rectangles are different.

$$\text{Area of top rectangle} = 25 \times 25 = 625 \text{ sqm}$$

$$\text{Area of bottom rectangle} = 20 \times 20 = 400 \text{ sqm}$$

$$\begin{aligned} \text{Average area of DOP} &= \frac{1}{2} \times (\text{Area of Top} + \text{Area of Bottom}) \\ &= \frac{1}{2} \times (625 + 400) = 512.50 \text{ sqm} \end{aligned}$$

$$\begin{aligned} \text{Volume of earth work for DOP} &= \text{Average Area of DOP} \times \text{Depth} \\ &= 512.5 \text{ sqm} \times 2.5 \text{ m} = 1,281.50 \text{ cum} \end{aligned}$$

$$\text{Unit rate for earthwork in hard soil} = \text{Rs. } 23.20/\text{cum}$$

$$\begin{aligned} \text{Cost of earthwork in hard soil for DOP} &= \text{Volume of Earthwork} \times \text{Unit Rate} \\ &= 1,281.50 \times 23.20 = \text{Rs. } 29,725 \end{aligned}$$

$$\begin{aligned} \text{Total cost for five DOPs} &= 5 \times 29,725 \\ &= \text{Rs. } 1,48,625 \end{aligned}$$

Example 8: Underground Dyke

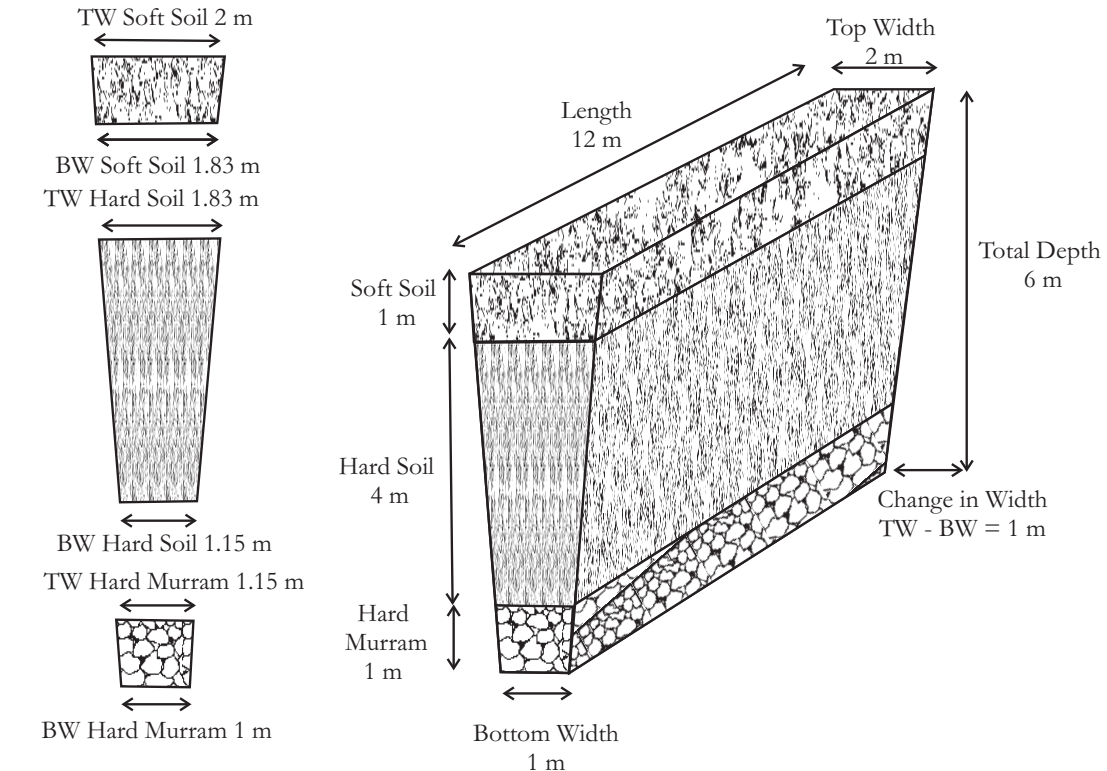

CROSS SECTIONS OF DIFFERENT STRATA IN AN UNDERGROUND DYKE

UNDERGROUND DYKE

So far, we have only talked about structures which involve digging and use the same soil for filling and/or raising an embankment. In underground dykes, we excavate one type of material from the ground and fill it with another type of material. Hence, the cost of excavation and the cost of filling have to be calculated separately.

Question: Find the cost estimate of an underground dyke of the following dimensions: Length = 12 m; Depth = 6 m; Top Width = 2 m; Bottom Width is 1 m. Total depth of 6 m consists of three strata -- soft soil (1m), hard soil (4m) and hard mooram (1m).

Solution

Step 1 ■ Rate at Which the Width Falls

Underground dykes have a shape that is the inverse of the structures we have made so far. It is also a trapezoid but one whose top width is more than its bottom width. Also since the dyke tapers down to the base, and since there are different strata at different depths, the challenge becomes of calculating the cross-section area at each depth. We need to know the rate at which its width is falling.

$$\begin{aligned} \text{Rate at which width falls} &= \frac{\text{Total fall in width}}{\text{Total depth}} \\ &= \frac{(\text{top width} - \text{bottom width})}{\text{total depth}} \\ &= \frac{(2 - 1)}{6} = 0.17 \text{ metre per metre} \end{aligned}$$

Step 2 ■ Volume of Excavation

a. In Soft Soil

$$\text{Top width of soft soil} = 2.0 \text{ m}$$

$$\begin{aligned} \text{Bottom width of soft soil} &= \text{Top width of soft soil} - (\text{Rate at which width falls} \\ &\quad \times \text{Depth of soft soil}) \\ &= 2 - (1 \times 0.17) = 1.83 \text{ m} \end{aligned}$$

$$\text{Area of soft soil excavation} = \frac{1}{2} \times (2 + 1.83) \times 1 = 1.92 \text{ sq.m.}$$

$$\begin{aligned} \text{Volume of soft soil excavation} &= \text{Area of soft soil excavation} \times \text{length of dyke} \\ &= 1.92 \times 12 \text{ m} = 22.98 \text{ cum} \end{aligned}$$

b. In Hard Soil

$$\text{Top width of hard soil} = \text{Bottom width of soft soil} = 1.83 \text{ m}$$

$$\begin{aligned} \text{Bottom width of hard soil} &= \text{Top width of hard soil} \\ &\quad - (\text{Rate at which width falls} \times \text{Depth of hard soil}) \\ &= 1.83 - (4 \times 0.17) = 1.15 \text{ m} \end{aligned}$$

$$\text{Area of hard soil excavation} = \frac{1}{2} \times (1.83 + 1.15) \times 4 = 5.90 \text{ sq.m.}$$

$$\begin{aligned} \text{Volume of hard soil excavation} &= \text{Area of hard soil excavation} \times \text{length of dyke} \\ &= 5.90 \times 12 \text{ m} = 71.52 \text{ cum} \end{aligned}$$

c. In Hard Moorum

$$\text{Top width of hard moorum} = \text{Bottom width of hard soil} = 1.15 \text{ m}$$

$$\text{Bottom width of hard moorum} = 1 \text{ m}$$

$$\text{Area of hard moorum excavation} = \frac{1}{2} \times (1.15 + 1) \times 1 = 1.08 \text{ sq.m.}$$

$$\text{Volume of hard moorum excavation} = 1.08 \text{ sqm} \times 12 \text{ m} = 12.96 \text{ cum}$$

d. Total Volume

$$\text{Total volume of excavation} = 22.98 + 71.52 + 12.96 = 107.46 \text{ cum}$$

Step 3 ■ Filling up the Dyke

In the dyke the new feature is that we fill it with something different from what we excavated. We fill clay puddling except in the top 0.30m in which we fill moorum.

a. Filling with Puddled Clay

$$\begin{aligned} \text{Top width of trapezium for clay puddling} &= \text{Top width of dyke} \\ &\quad - (\text{Rate at which width falls} \\ &\quad \times 0.30) \\ &= 2 - (0.17 \times 0.30) = 1.95 \text{ m} \\ \text{Volume of clay puddling} &= \frac{1}{2} \times (\text{Top width} + \text{Bottom width}) \\ &\quad \times \text{Depth} \times \text{Length} \\ &= \frac{1}{2} \times (1.95 + 1.00) \times 5.70 \times 12 \\ &= 100.89 \text{ cum}[-0.5ex] \end{aligned}$$

b. Filling with Moorum

$$\begin{aligned} \text{Volume of moorum filling} &= \frac{1}{2} \times (\text{Top width} + \text{Top width of clay puddle}) \\ &\quad \times \text{Depth} \times \text{Length of dyke} \\ &= \frac{1}{2} \times (2.00 + 1.95) \times 0.30 \times 12 = 7.11 \text{ cum} \end{aligned}$$

Cost Sheet for Underground Dyke

	Particulars	Unit	Volume	Rate/Unit (Rs.)	Amount (Rs.)
1	Excavation in Soft Soil	Cum	22.98	17.90	411
2	Excavation in Hard Soil	Cum	71.52	23.20	1,659
3	Excavation in Hard Mooram	Cum	12.96	30.70	398
4	Puddle Filling with Good Clay	Cum	100.89	104.00	10,493
5	Mooram Filling over Clay Puddle	Cum	7.11	30.70	218
6	Total Cost of Underground Dyke				12,791

Example 9: Gabion Structure

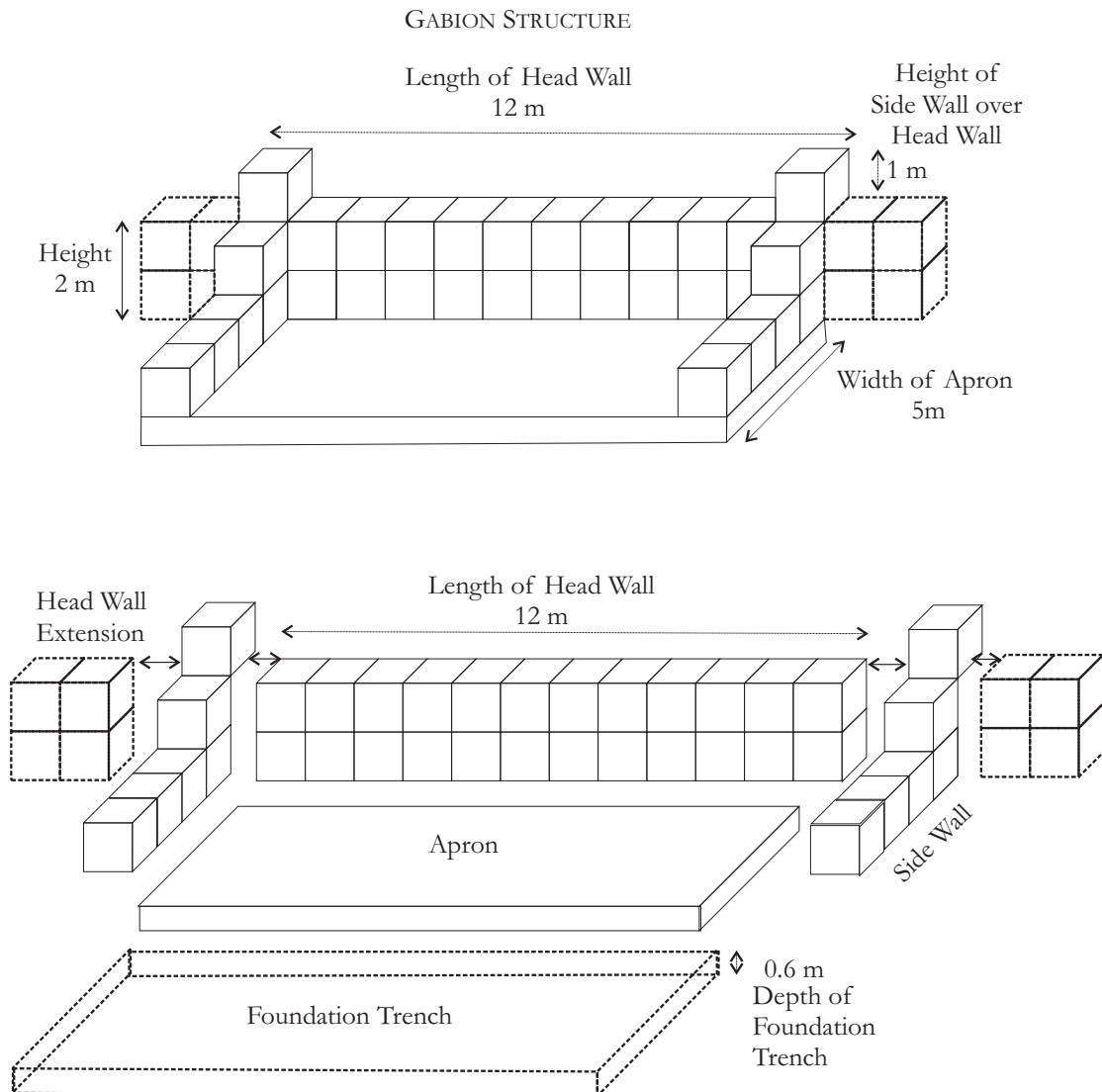

Find the cost of a Gabion Structure (GS) with the following parameters:

- * Length = 12 m (see figure above)
- * Height of head wall = 2.0m
- * Depth of foundation at all points = 0.6m
- * Length of headwall extension = 2m
- * Height of sidewalls over headwall = 1m
- * Width of apron = 5m.

Step 1 ■ Excavation

1. Excavation for apron and main wall foundation in hard soil

$$\begin{aligned}
 &= Length \times Width \times Depth \\
 &= 12 \times (5 + 1) \times 0.60 \\
 &= 43.2 \text{ cum}
 \end{aligned}$$

2. Excavation for head wall extension in hard soil

$$\begin{aligned}
 &= 2 \times Length \times Width \times Depth \\
 &= 2 \times 2 \times 2 \times 2 = 16 \text{ cum}
 \end{aligned}$$

3. Boulder filling for apron and main wall foundation

$$\begin{aligned}
 &= Length \times Width \times Depth \\
 &= 12 \times (5 + 1) \times 0.6 \\
 &= 43.2 \text{ cum}
 \end{aligned}$$

Step 2 ■ Area of wire mesh

1. Area of wire mesh on apron and main wall foundation

$$\begin{aligned}
 &= Length \times Width \\
 &= 12 \times (5 + 1) \\
 &= 72 \text{ sqm}
 \end{aligned}$$

2. Area of wire mesh for keying of apron

$$\begin{aligned}
 &= Length \times Width \\
 &= (12 + 12 + 5 + 1 + 5 + 1) \times 1 \\
 &= 36 \text{ sqm}
 \end{aligned}$$

3. Total area of wire mesh apron: = 72 + 36 = 108 sqm

Step 3 ■ Gabion Boxes

As we know the gabion is made with GI wire mesh cubical boxes of 1.0 m. filled with the boulders. For making one cubical box of 1 cum capacity:

Quantity of boulder required = 1.00 cum

Quantity of wire mesh required = 5.00 sqm (As out of the six faces of cube two faces will remain common for joining the two boxes)

For estimating the quantity of GS, we have to count the number of boxes in each part of the structure:

- * Total boxes for main wall = Number of boxes in the main wall c/s \times Length of GS = $2 \times 12 = 24$ boxes
- * Total boxes for both sidewalls = Number of boxes in the side wall c/s $\times 2 = 6 \times 2 = 12$ boxes
- * Total boxes for both side head wall extensions = No. of boxes in the head wall extensions $\times 2 = 4 \times 2 = 8$ boxes
- * Total boxes for main wall + sidewall + extension wall = $24 + 12 + 8 = 44$ Boxes
- * Total quantity of wire mesh required for main wall + sidewall + extension wall = No. of boxes $\times 5 = 44 \times 5 = 220$ sqm

$$\text{Volume of Reverse Filter} = \frac{1}{2} \times 1 \times 2 \times 12 = 12 \text{ cum}$$

Step 4 ■ Total Cost

Cost Sheet for Gabion Structure

No.	Particulars of work	A/U	Quantity	Rate	Amount
1.	Earthwork in hard soil for apron and main wall foundation	Cum	43.20	23.20	1,002.20
2.	Earthwork in hard soil for head wall extension	Cum	16.00	23.20	371.20
3.	Boulder filling for apron and main wall foundation	Cum	43.20	39.30	1,697.80
4.	Wire mesh for apron	Sqm	108.00	60.00	6,480.00
5.	Boulder filling for head wall, side wall and head wall extension	Cum	44.00	39.30	1,729.20
6.	Wire mesh for head wall, side wall and head wall extension	Sqm	220.00	60.00	13,200.00
7.	Reverse filter on upstream side	Cum	12.00	136.00	1,632.00
	Total cost of Gabion Structure	Rs.			26,112.40

Note: Calculation of wire mesh becomes more complicated as the Gabion Structure's length and height go up. Since the headwall is made in the form of steps, many more boxes will have common faces and hence the average number of faces per box, depending on the length and height of the structure, could go down to 4.

Example 10: Earthen Dam

Estimate the cost of an Earthen Dam 20 metres in length and a maximum height of 5 metres. The upstream and downstream slopes are 1:3 and 1:2 respectively. Top width of the dam is 2.5 metres, depth and width of the cutoff trench are 2.5m and 1m respectively. Freeboard = 1m. Height of the dam at different points along the dam is given below:

Point	A	B	C	D	E
Height	0	2	5	3	0
Distance	0	A→B= 5 m	B→C= 5 m	C→D= 5 m	D→E= 5 m

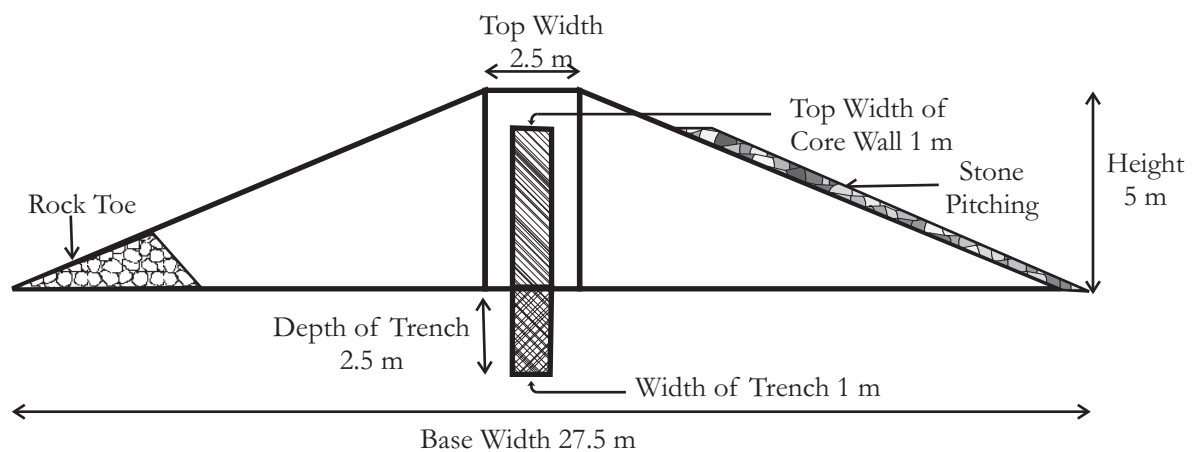
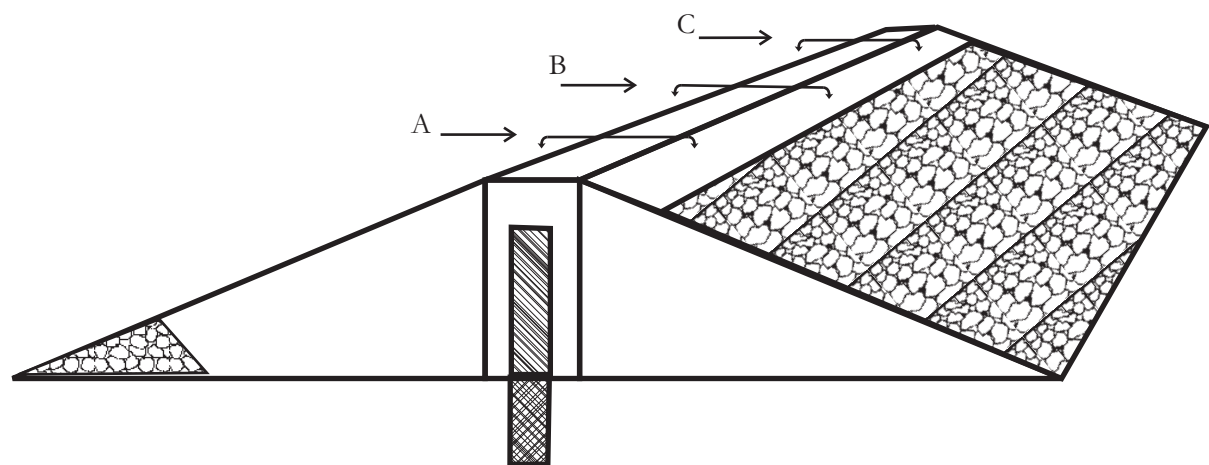

CROSS SECTION OF THE DAM AT POINT C

Solution

The cross section of an earthen dam is in the shape of a trapezium partitioned into different segments. Each segment is constructed in one type of material. Both the **hearting/casing** type of dam and **corewall** type of dam have **three** segments: the

hearting/corewall with clay soil, the casing/outer cover with more pervious material and rock toe filter on the downstream side. Hence, it is necessary to calculate the cross section area and volume of each of the segments of the dam wall and work out cost of construction. First, we work out the volume of total embankment and then deduct volumes of corewall and rock toe from it to get the volume of casing/outer cover. Then, we add other items such as the cost of excavation and filling of cutoff trench, cost of pitching of the upstream outer face, cost of construction of exit weir etc.

An important point to be remembered while costing an earthen structure is that the height of the structure for calculations is always the **design height** and never the actual height after construction. This is because actual height includes the settlement allowance, which should **not** get into any calculations of cost.

Step 1 ■ Volume of Cutoff Trench

$$= \text{Length} \times \text{Width} \times \text{Depth}$$

$$= 20 \times 1 \times 2.5 = 50 \text{ cum}$$

Step 2 ■ Volume of Embankment

Volume of embankment is calculated by multiplying the cross section area with length. Cross section area at each point on the structure is calculated by the following formula for a trapezium:

$$\text{Area of Cross Section} = \frac{1}{2} \times (S \times H^2) + (TW \times H)$$

$$\text{where, } S = S_1 + S_2, \text{ (sum of upstream and downstream slopes)}$$

$$H = \text{Height of the structure at any point}$$

$$TW = \text{Top width of structure} = 2.5 \text{ m}$$

$$S_1 = 3 \text{ and } S_2 = 2$$

Using the above formula, we calculate the area of cross section at each point. Multiplying the average cross section area between two points with the distance between the two points, we get the volume of the section.

Estimation of volume of embankment

Station (1)	Chainage (2)	Height (3)	Cross Section Area (4)	Average Cross section (5)	Length of Section (6)	Quantity (7 = 5x6)
A	0	0	0	-	-	-
B	5.0	2.0	15.0	7.5	5.0	37.5
C	10.0	5.0	75.0	45.0	5.0	225.0
D	15.0	3.0	30.0	52.5	5.0	262.5
E	20.0	0	0	15.0	5.0	75.0
Total volume of embankment						600.0 cum

Step 3 ■ Volume of Corewall

Cross section area of corewall = Width of corewall × Height of corewall

Height of corewall = Height of bund – Free board

Width of corewall = 1.00 m

Free board = 1.00 m

$$\begin{aligned} \therefore \text{Cross section area of corewall} &= \text{Width} \times (H - \text{Freeboard}) \\ &= 1.00 \times (H - 1) = H - 1 \text{ m} \end{aligned}$$

Estimation of volume of Corewall

Station (1)	Chainage (2)	Height (3)	Cross Section Area (4)	Average Cross section (5)	Length of Section (6)	Quantity (7 = 5x6)
A	0	0	0	-	-	-
B	5.00	2.00	1.00	0.50	5.00	2.50
C	10.00	5.00	4.00	2.50	5.00	12.50
D	15.00	3.00	2.00	3.00	5.00	15.00
E	20.00	0	0	1.00	5.00	5.00
Total volume of corewall						35.00 Cum

Step 4 ■ Volume of Rock toe

$$\text{Cross section area of the Rock Toe} = \left(\frac{1 + S_2^2}{S_2} \right) \times \frac{H^2}{32}$$

We know that $S_2 = 2$

$$\begin{aligned} \text{Cross section area} &= \left(\frac{1 + 2^2}{2} \right) \times \frac{H^2}{32} \\ &= \frac{5}{2} \times \frac{H^2}{32} = \frac{5}{64} \times H^2 \end{aligned}$$

Estimation of volume of Rock Toe

Station (1)	Chainage (2)	Height (3)	Cross Section Area (4)	Average Cross section (5)	Length of Section (6)	Quantity (7 = 5x6)
A	0	0	0	-	-	-
B	5.00	2.00	0.31	0.15	5.00	0.75
C	10.00	5.00	1.95	1.13	5.00	5.65
D	15.00	3.00	0.70	1.33	5.00	6.65
E	20.00	0	0	0.35	5.00	1.75
Total volume of rock toe						14.80 cum

Step 5 ■ Volume of casing/outer cover

$$\begin{aligned} \text{Total volume of dam} &= (\text{Volume of core wall} + \text{Volume of rock toe}) \\ &= 600 - (35 + 14.80) = 550.20 \text{ cum} \end{aligned}$$

Step 6 ■ Excavation for Exit

The exit is rectangular in shape

$$\begin{aligned} \therefore \text{Volume of excavation for exit} &= \text{Length} \times \text{Width} \times \text{Height} \\ &= 10 \text{ m} \times 4 \text{ m} \times 1.5 \text{ m} = 60 \text{ cum} \end{aligned}$$

Step 7 ■ Total Cost**Cost Sheet for Earthen Dam**

	Particulars of work	Unit	Volume/ Area	Rate/Unit (Rs.)	Amount (Rs.)
1	Excavation for Cutoff Trench in Hard Soil	Cum	50.00	23.20	1,160.00
2	Filling Cutoff Trench with Puddled Clay	Cum	50.00	104.00	5,220.00
3	Construction of Casing in Hard Soil	Cum	550.20	28.30	15,571.00
4	Construction of Clay Corewall	Cum	35.00	104.00	3,640.00
5	Construction of Rock Toe Filter	Cum	14.80	124.65	1,845.00
6	Excavation for Exit Weir	Cum	60.00	30.70	1,842.00
	Total Cost of Dam Construction				29,278.00

References

1. Dutta, B.N. (1966): *Estimating and Costing for Civil Engineering*, Lucknow
2. Khanna, P.N. (1996): *Indian Practical Civil Engineers' Handbook*, New Delhi: Engineers' Publishers

16 | Schedule of Rates: A Re-Examination

16.1 Objectives of NREGA

The NREGA states:

"Under no circumstances shall the labourers be paid less than the wage rate"
[Schedule I, Section 6]

"Until such time as a wage rate is fixed by the Central Government, every person working under the Scheme shall be entitled to wages at the minimum wage rate fixed by the State Government for agricultural labourers under the Minimum Wages Act, 1948"
[Chapter III, Section 6 (2)]

"When wages are directly linked with the quantity of work, the wages shall be paid according to the schedule of rates fixed by the State Government for different types of work every year, in consultation with the State Council"
[Schedule I, Section 7]

"The schedule of rates of wages for unskilled labourers shall be so fixed that a person working for seven hours would normally earn a wage equal to the wage rate"
[Schedule I, Section 8]

"The cost of material component of projects including the wages of the skilled and semi-skilled workers taken up under the Scheme shall not exceed forty per cent. of the total project costs"
[Schedule I, Section 9]

"As far as practicable, a task funded under the Scheme shall be performed by using manual labour and not machines."
[Schedule I, Section 12]

"The Scheme shall not permit engaging any contractor for implementation of the projects under it"
[Schedule I, Section 11]

"Every Scheme shall contain adequate provisions for ensuring transparency and accountability at all level of implementation"

[Schedule I, Section 13]

"Creation of durable assets and strengthening the livelihood resource base of the rural poor shall be an important objective of the Scheme"

[Schedule I, Section 2]

Thus, the NREGA is simultaneously committed to

1. employment generation
2. payment of minimum wages
3. not using contractors
4. not using labour-displacing machines
5. preventing leakages and corruption and
6. creation of durable assets to strengthen rural livelihoods

The programme is, therefore, committed to promoting labour-intensive work that provides employment wages, in a people-centred, transparent and accountable manner, in a way that leads to creation of productive assets, which strengthens rural livelihoods. In this chapter, we will show that the simultaneous attainment of all these objectives poses a real challenge. This is because of what we call a deep contradiction at the heart of NREGA implementation. If we want the programme to lead to creation of durable assets, valuation of work done by labour becomes essential. Standards of productivity have to be adhered to while fully respecting labour rights. The present method of valuing work is based on the Schedule of Rates (SoRs) described in the last chapter. In this chapter, we will argue that both the way the SoRs have been devised and the way they are deployed make it virtually impossible for the objectives of the NREGA to be attained. We believe that the SoRs as presently conceived and used have an inherent pro-contractor bias, encourage (virtually necessitate) the use of machinery and make it very difficult for workers to earn the statutory minimum wages.

16.2 What does a Task Rate Signify?

Let us now understand what a task rate signifies. It tells us how to determine the value of a certain volume of work done, quite irrespective of the number of workers who performed the task or the time taken for it.

Suppose that 10 labourers are employed for excavation work in ordinary soil. Let us also assume that the minimum wage to be paid is Rs. 60 per person-day. The wage cost per day is Rs. 60 x 10 = Rs. 600. Now suppose that the labour rate for excavation in this

stratum is Rs. 35.60 per cubic metre (GoJ, 2004). This means that in order to earn the minimum wage, the ten labourers together should produce a volume of work that would entitle them to the minimum wage. To arrive at this volume of work, we divide the total minimum wage of 10 workers by the labour rate, i.e., $\text{Rs.}600/35.60 = 16.85$ cubic metre or 1.685 cubic metres per person. This is the amount of work that an *average* worker, under *average* working conditions is supposed to do in a normal 8-hour working day, with a 1-hour break in the middle if she is to earn the daily minimum wage.

16.3 How is the Task Rate arrived at?

In principle, the task rate is supposed to be arrived at by conducting a series of what are called "time and motion studies" that help estimate the amount of work labour should be able to do in different circumstances. We illustrate this with the example of how earthwork excavation rates in foundation trenches were arrived at in Patna division in Bihar (GoB, 2005). Time and motion studies supposedly revealed that 11 average workers were required to excavate 1000 cu.ft. in foundation trenches in ordinary soil. To imagine what this work is you could visualise a trench that is 100 ft long, 10 ft. wide and 1 foot deep. Now to estimate the value of the work that went into digging this trench, the Government of Bihar carries out what is called **Rate Analysis**, which is simply the valuation of each component that went into this work.

Table 16.1
Evaluation of each component of work

1. Unskilled Labour 11 no @Rs.68/day (min wage)	Rs.748.00
2. Mason Grade II 0.25 no @Rs. 82/day (min wage) (each mason works for one-fourth day)	Rs. 20.50
3. Sundries	Rs. 4.50
Sub-Total	Rs. 773.00
4. Add 10% for Contractor's Profits	Rs. 77.30
Total Cost for 1000 cu.ft(28.32 cum)	Rs. 850.30

Hence the cost per cubic metre works out to $(850.30/28.32) = \text{Rs. } 30/\text{cum}$. This is the rate you will find in the SoR of the Government of Bihar. We must always remember that all these rates are not mysterious entities that have transpired from thin air. They all have an underlying assumption about productivity of labour that may or may not be valid. Though this assumption is fundamental to the whole rate structure of the SoRs, it is rarely spelt out, except in a few cases. For instance, GoWB (1999) reveals the following productivity norms (cubic metres per day) for earthwork excavation in different strata.

Table 16.2
Productivity Norms (cum per day) for Earthwork Excavation
in Foundation Trenches

Strata	Lead upto 25 m	Lead 25-50 m	Lead 50-75 m
Loose Soft Soil	2.50	2.42	2.35
Kankar/Mooram Soil	2.30	2.18	2.11
Mooram, Laterite, Boulder	1.90	1.89	1.78
Soft Rock requiring Blasting	0.80	0.75	0.73
Hard Rock	0.30	0.24	0.23

Note: Lead refers to the distance for the disposal of excavated material

Source: GoWB (1999)

The West Bengal table shows how rates vary according to the nature of the work, the material worked upon and the distance and height of transport of material ("lead and lift"). We can illustrate the same point from the Jharkhand SoR for the North Chhota Nagpur division (GoJ, 2005) we find that for the same work in different strata the rates are different:

Description of Work	Unit	Rate per unit (Rs)
Earthwork in excavation of foundation trenches in all kinds of soils	cum	41.05
Earthwork in excavation of foundation trenches in soft rock or ordinary rock	cum	130.00

Thus, we find that the same work done in harder strata is valued at a higher rate. In the same SoR from Jharkhand we find that different activities in the same stratum are also valued differently.

Description of Work	Unit	Rate per unit (Rs)
Earthwork in stripping in all kinds of soils	cum	44.60
Earthwork in excavation of foundation trenches in all kinds of soils	cum	41.05

Rates are also different when the lead is different even within the same stratum.

Description of Work	Unit	Rate per unit (Rs)
Earthwork in excavation of foundation trenches in all kinds of soils and disposal of the soils with a lead of 50-150 m	cum	41.05
Earthwork in excavation of foundation trenches in all kinds of soils and disposal of the soils with lead 150 m-1 km	cum	97.40

Again we find that when the work involved is lifting of material the rates of valuation will be different for different material even if they have to be lifted from the same depth.

We illustrate this through the SoR of the Department of Water Resources, Government of Madhya Pradesh (GoMP, 2003).

Description of Work	Unit	Rate per unit (Rs)
Description of Work	Unit	Rate per unit (Rs)
Extra rate beyond initial 1.5 m. lift for every additional lift of 0.3 m. for ordinary soil, hard soil and hard mooram	cum	0.90
Extra rate beyond initial 1.5 m. lift for every additional lift of 0.3 m. for disintegrated rock, soft rock and hard rock	cum	1.40

Clearly, there is an attempt to vary the valuation of work in proportion to the arduousness of the task.

Thus, the SoR sets up an equivalence between the physical quantum of work performed and the financial payments to be incurred. This equivalence is arrived at on the basis of the estimated quantum of work an *average* worker can perform in different strata. The SoRs assume that the average productivity of an average worker will be uniform throughout the state or any other administrative unit.

In this chapter, we will show how many of the underlying presumptions in arriving at these rates need to be questioned and the reasons why this must be done. We will also argue strongly for a radically more transparent process of arriving at the productivity norms that underlie these rates.

16.4 Problems of Using Schedule of Rates and Possible Modifications

16.4.1 Inability to Address Variations

The notion of average underlying the SoR (average rate for whole state and that of an average worker) is endemically unjust. There are various ways in which this injustice manifests itself. The amount of work performed by a hypothetical *average* worker acts as the implicit productivity norm for all workers to adhere to. It follows that to earn the statutory minimum wage, each worker has to work at a pace equal to that of the *average* worker. The slower s/he works, the wider will be the gap between actual earnings and the statutory minimum wage. Many factors specific to the location of work could be responsible for the slowing down of the pace of work.

16.4.1.1 Variations in Geological Strata

Earthwork excavation takes place across geological strata that vary in hardness and compaction. The SoR usually recognises only a few types of strata. The rates are different for each of these strata. The logic is that each strata requires different tools/implements for working on them. GoMP details seven types of strata on the basis of implements used, the mix of earth, boulders and the extent of compaction (GoMP, 2003).¹

Table 16.3
Tools/Implements to be Used in Different Strata

Strata	Tools/Implements
Soft soil	Yields to ordinary application of pick, shovel, spade, rake
Hard soil	Removed with shovel, spade after loosening with pick-axe
Hard mooram	Close application of picks, jumpers or scarifiers to loosen
Disintegrated rock	Close application of a combination crowbars, picks, grafting tools and scarifiers
Soft rock	Requires quarrying or splitting with crowbars or casual blasting
Hard rock	Requires blasting or chisels/wedges

Source: GoMP (2003)

SoRs for other states follow different classifications following their respective geological configurations, but rates are always arranged in an ascending order of hardness.

Table 16.4: Types of Geological Strata Identified in SoRs of Different States

State	No of Strata	Name
Rajasthan	5	Ordinary/Soft Soil, Hard/Clayey/Kanker Soil, Disintegrated Rock, Ordinary Rock, Hard Rock with Blasting
Madhya Pradesh	7	Soft Soil, Hard Soil, Hard Mooram, Disintegrated Rock, Hard Rock with Blasting, Hard Rock Without Blasting

¹ For instance, the description of hard soil is as follows: "Generally any material which requires the close application of picks, jumpers or scarifiers to loosen, such as hard and compact mooram and soft shale. Mooram of soil mixed with small boulders not exceeding 25% in quantity and each less than 0.014 cum but more than 0.004 cum in size". This is too precise a definition and it is difficult to find any strata conforming to this description exactly.

State	No of Strata	Name
Maharashtra	6	All Soils, Hard Mooram, Hard Mooram with Boulders, Soft Rock, Soft Rock with Blasting, Hard Rock
Chhatisgarh	7	Soft Soil, Hard Soil, Hard Mooram, Disintegrated Rock, Hard Rock with Blasting, Hard Rock Without Blasting
Bihar	4	Soft Soil, Mooram Soil, Soft Rock, Hard Rock
Jharkhand	4	Soft Soil, Mooram Soil, Soft Rock, Hard Rock
West Bengal	5	Loose Soil, Kanker/Mooram Soil, Kanker-Boulder-Laterite, Soft Rock Requiring Blasting, Hard Rock
Karnataka	4	All Soils, Soft Rock without Blasting, Soft Rock with Blasting, Hard Rock of all Toughness

Sources: GoR (2004), GoMP (2003), GoM (2001), GoC (2004), GoB (2005), GoJ (2004), GoJ (2005), GoWB (2005), GoK (2004)

However, the fact is that nature cannot be straitjacketed into a few strata. Geological strata in hard rock areas in particular vary quite substantially within even a small watershed of 1000 hectares. SoRs as they exist now cannot address these variations without subsuming them under one of the 6 or 7 categories mentioned above. The problem becomes very acute when there are sharp jumps in rates of excavation between the strata whereas in actual world, what one would find is a gradual change, with a number of intermediate strata. To give an example from Madhya Pradesh, the rates across strata move as follows:

Table 16.5
Rates for Excavation in Different Types of Soil

	Excavation and Earthwork	Rs/Cum
301(a)	Soft Soil	17.90
301(b)	Hard Soil	23.20
301(c)	Hard Mooram (HM)	30.70
302(a)	Disintegrated Rock (DR)	77.10
302(b)	Hard Rock Requiring Blasting	98.40
302(c)	Hard Rock Requiring where Blasting is Prohibited	162.90

Source: Combined Schedule of Rates, *Rural Engineering Service, GoMP, 2003*

There is a massive jump from the rate for HM to that for DR. Usually, DR rates are not allowed in watershed works. As a result, only HM rates can be used. And these tend to underpay workers. The way out, therefore, is to devise at least two or three

intermediate rates between HM and DR.

16.4.1.2 Variations in Conditions of Work

Working conditions may be rendered difficult by site-specific conditions. As excavation becomes deeper, the additional task of picking up (**lift**) and transporting (**lead**) the excavated material away from the work site may slow down the pace of work. In the case of earthen dams, as the height of the dam increases, workers have to walk longer distances and climb up and down, which again slows down pace of work. While making corewalls in embankments, the clayey soil needs to be worked on more by watering and kneading (**puddling**), which takes up time. While digging in tank beds and water courses, excavation may get difficult due to intrusion of water (**wet excavation**). Dewatering and desilting operations may have to be done here. In many remote sites there are delays caused simply by the difficulties of transporting water from distant sources. These delays are for no fault of the workers themselves. The SoRs try to address these difficulties by providing higher rates for lead, lift, puddling and wet excavation. But our experience across half a million acres of watershed works in 50 most backward districts of India shows that all true costs are not always reflected even in these rates.

For example, in Maharashtra we have the following rates to take care of the cost of lead:

Table 16.6
Rates for lead in hearting-type bund construction in Maharashtra

Description	Unit	Rate (Rs)
Providing and constructing embankment for hearting zone selected materials from borrow pits incl conveying the material for various leads		
a. for lead upto 500 m	cum	73.70
b. for lead from 500m to 1 km	cum	76.20
c. for lead from 1 km to 5 km	cum	94.00

Source: GoM (2001)

Category c is far too broad and needs to be broken up into sub-categories so that leads over 2 km are properly compensated. At least a small attempt in this direction has been made in the rates followed by the Rural Engineering Service in Madhya Pradesh (GoMP, 2003a) where rates vary for leads of every 500 m for soils and every 200m for water.

Thus, a fundamental re-examination of this issue is required in each geophysical

context in a truly participatory manner so that the loss of wages to workers through factors external to their own productivity is compensated by devising fairer rates.

16.4.1.3 Variations in Climate

Average rates prescribed in the SoRs usually have no reference to the climatic conditions where work takes place. For instance, in areas characterised by hot summers with temperatures of 45 degrees and above, work pace slows down considerably during the peak summer months. In coastal plains and hot sub-humid regions, humidity could be a very important factor influencing the quantum of work done. None of these factors seem to have informed the SoRs in use in these areas.

In the case of areas with high temperature, deviation from average temperature at the state level must be considered. If the daily mean temperature of an area is higher than the state average, then a percentage should be added to the existing rate. Peak summer months in a year can be declared as "hot months" and the rate should automatically be higher than normal. In these "hot months", the length of the working day could be restricted to 6 hours without reducing the minimum wage rate. This effectively means that we downscale the output norm for these areas.

16.4.1.4 Variations within Workforce and Weeding Out "Slow Workers"

The underlying notion of the SoR is that the workforce is healthy and capable of hard work ("good workers"). The daily productivity of a poor, malnourished and physically challenged worker will be lower than this average. Hence, even when the SoR is strictly implemented, such persons ("slow workers") will get weeded out. The good workers are often the able-bodied, young men and women and the slow workers are the physically weaker men and women, the aged and the physically challenged. The notion of the average worker does not allow for gender and age differences in productivity. Again, such persons will not get a just treatment even when the SoR is followed honestly. Studies have shown that particular communities such as the Primitive Tribe Groups (like the Sahariyas in MP and Rajasthan) have for a variety of historical factors inherited a weaker physical constitution. In all such instances, payments should be made only on time-rates and no reference will be made to the Schedule of Rates. Special provisions for extra rates above the normal rates should be provided for in the SoR for work undertaken in severely drought-prone, malnourished, hazardous, disability-prone and tribal areas.

16.4.2 Non-Payment of Minimum Wages

If, due to variations observed above, the actual work output is less than that of the productivity of the average worker, the contractor has a strong disincentive to pay minimum wages. The simplest option available for the contractor is to squeeze labour. The labour rate of the SoR here becomes the *piece rate* on the basis of which payment is decided. The productivity of the hypothetical *average* worker becomes the norm for the entire group of workers.

In the example given early in this chapter, the productivity norm is 16.85 cubic metres by 10 workers. Thus, if the 10 workers together are able to produce only 15 cubic metres of work during a normal working day, the total wage payment for that day will be calculated as Rs. 534 or Rs. 53.4 rupees per worker instead of the minimum wage of Rs. 60.² Therefore, the contractor will pay less than minimum wages on the argument that "the workers have not worked enough". Alternatively, the contractor can also make the workers work more by extending the working day so that the average productivity norm of 16.85 cubic metres per day is achieved. Assuming that the length of a normal working day is 8 hours, in this case he will effectively extend it to $(16.85/15 \times 8) =$ about 9 hours. At times, this happens "invisibly", whereby the productivity target is given to a group of workers and they are asked to do it "at their convenience". This means that the time taken for the task is not reflected in the payment made or in other words no compensation is provided for "overtime" work. Unpaid work is sometimes also increased by employing children as low paid workers, i.e., those who are paid less than minimum wages.

16.4.3 Delay in Revising Basic Rates

As we saw earlier, the labour rates in the SoR are derived from the statutory minimum wage of the region. However, minimum wages undergo revision every year depending on inflation and the movement of cost of living indices. The SoR on the other hand is revised only periodically, once in 4 to 5 years. Inflation is, therefore, not taken into account. A standard indexing procedure needs to be followed by which rates must customarily be raised in line with the rise in statutory minimum wages. Taking examples from a few selected states, we need to see whether the revisions in SoR rates have been able to keep pace with the increase in minimum wages. It may be noted that when the SoR of RES of GoMP was revised in 2003 over the previous one of 1995, the escalation in rates for specific activities was not as much as the increase in

² This statement ignores the fact that rate as specified in the SoR is inclusive of provisions for contractor's profit and overheads, tools & plants and sundries. This percentage works out to 13% in GoMP, 2003 (p.5). Hence, the actual payment to workers will be that much less than Rs. 53.4.

minimum wages. It is not even sufficient that the rates are brought in line with rise in minimum wages periodically, since this would mean that in the intervening years, there could be discrepancy between wage payments and work output. SoRs must, therefore, have a provision for cost escalation on a yearly basis, to keep pace with minimum wage revisions.³ Of course, this presumes that the minimum wages themselves will be raised to reflect increased cost of living for workers. This has unfortunately not always been the case either.

There can be two methods to cover cost escalations. In the first method, one can (like GoWB does) come upfront with the implicit productivity norm underlying a rate. Dividing the minimum wage of each year with this figure, we arrive at the cost per cubic metre of that particular type of work. Whenever the minimum wage goes up, the exercise can be repeated to get the new rates in line with the revised wage rate. The other method could be to peg SoR rates to changes in minimum wage rates (since labour cost would account for 60-100% of the total cost of NREGA). The rate of escalation of minimum wage per annum can be used to escalate the rates of SoR as well. The simplest, of course, is to revise the SoR itself every year (as SRC has recommended for Karnataka, SRC, 2003).

16.4.4 Composite Items

The list of items for earthwork excavation includes some composite items such as puddle filling, embankment construction or stone pitching. For instance, Item No. 415(c) of GoMP, 2003 gives the following full description of the activity:

"Earth work for bund in hearting or casing with approved soils including dressing, breaking of clods, laying layers of 15 cm thickness, cutting and finishing U/S and D/S slopes of bunds including 50 m lead and 1.5 m lift of all materials and other charges but excluding watering and compaction".

As we can see within this one item, many different activities have been lumped together:

1. dressing of layers
2. breaking of clods
3. laying layers of soil
4. cutting of slopes
5. finishing of slopes

In addition there is a "hidden" activity that is not mentioned at all – excavation of the mud that is being used to do all the work described in this item. Many of these end up

³ The Guidelines of SRC of GoK recommends that SoR should be compulsorily revised every year.

becoming under-paid activities. There is a need to break up these kinds of composite items into distinct activities, many of which have (or need to have) separate rates within the SoR. The most onerous sub-activity should be pegged at the minimum wage.⁴

16.4.5 No Provision to Accommodate "Hidden Costs" of Labour

As opposed to contractor based systems where no protection is offered to unskilled and semi-skilled workforce, the NREGA contains several provisions for insurance against accidents, disability and death while on duty, provision of medical aid, drinking water, care of children etc. The NREGA Guidelines state that, "if workers are willing, then a State Government may consider dovetailing wage payments under REGS with social security arrangements... such as health insurance, accident insurance, survivor benefits, maternity benefits and other social security arrangements. Such a social security cover will be purely voluntary"(p.26-27). Such payments mainly contribute to workers' welfare and do not necessarily reflect in higher work output. Since the SoR has no provision to accommodate such payments, these are often referred to as the "hidden costs" of labour. The NREGA should be able to finance such hidden costs by including them as part of the SoR. The SoR of Karnataka has shown a way forward in this direction by including the hidden costs (albeit with an upper ceiling of 15%) as part of the wage cost (GoK, 2003)

As explained already, the rates in SoR includes an element for Contractor's Profit (usually around 10 – 13% of total cost). Since contractors are not allowed in NREGA, this part of the total cost could be used for providing social security to workers. The GoK estimate of 15 – 25% can be taken as a broad norm (see Table 16.8).

16.4.6 Endemic Tendency towards Mechanisation

It should be remembered that the SoRs essentially comprise rates paid to contractors for work undertaken. Their refusal to address variations coupled with delays in upward revisions implies that SoR rates are structured to provide a powerful incentive to replace labour with machines. Since the productivity of machines is higher than that of labour, the required quantity will be achieved faster and at a lower cost by employing machines.

⁴ Moreover, these activities are sequentially arranged and delay in one might cause delays down the line. For instance, unless the first layer of soil is watered and compacted, the next layer cannot be placed on top of it. Unless puddle filling proceeds at the same pace, embankment construction will get delayed. The workers down-the-line will, therefore, be unable to meet productivity targets and hence not earn minimum wages. This calls for better organisation of work at the site

Table 16.7
Hidden Costs on Labour in Karnataka (% of Labour Cost)

Item	Canal	Dam	Tunnel
Paid Holidays	2.05	2.60	4.50
Housing for Migrant Labour	3.30	4.40	4.90
Workmen's Compensation	1.00	2.00	3.00
Medical Facilities	1.50	2.00	2.50
Gratuity	0.30	0.60	1.40
Provident Fund	2.70	3.35	3.60
Others	4.10	4.25	5.30
Total	14.95	19.20	25.20

Source: SRC, 2003

Once machines are banned⁵, with the existing rates it will be impossible to meet the costs of employing labour. This is perhaps the single most important ground for revising all labour rates upwards.

If rates are not revised upwards, Village Panchayats who pay statutory minimum wages and avoid using machines under NREGA, will find it impossible to complete works within their sanctioned costs. This will act as an incentive for corrupt practices, such as exaggerating the physical quantity of work done. Outlays will not be matched by outcomes (except on paper). Or labourers will not get their due.

16.5 Transparency in the Process of Preparation of SoRs

Thus, in their orientation, the SoRs are fundamentally anti-labour. The question then is: can the SoRs as they exist now be used for assessing productivity in an employment guarantee programme like the NREGA? The answer is clearly no. If the SoRs, in their current status, are used to evaluate NREGA, it would inevitably lead to violation of minimum wage laws, use of contractors and use of machines. Hence, the SoRs need to be fundamentally modified to take care of these aspects.

However, given the current thinking among those in-charge of making these rates, this may not prove an easy task. Some makers of SoRs argue that it is neither possible nor desirable to accommodate regional variations while deciding on rates. Their fear is that

⁵ Although NREGA places a blanket ban on all machines, it is our considered view that where machines are not labour-displacing but merely reduce the drudgery of work, they must be encouraged. This includes, for example, the use of tractors for transporting material from long distances and the use of pumpsets for lifting water. There are also instances where the use of machines may become critical for protecting a structure from collapse. For instance, rollers may need to be used in large earthen dams for compaction where reliance on human labour could irreparably delay matters, apart from the sheer drudgery of the work itself.

this leaves too much in the hands of the implementers and could lead to proliferation of different rates for same kind of activity. For instance, the Schedule of Rates Committee (SRC, 2003) of GoK observes:

"The Committee deliberated at length to consider whether the schedule of rates should be for each circle or a common schedule of rates should be proposed to cover the entire State. The committee noted that the rates for labour are uniform throughout the State. The Variable Dearness Allowance (VDA) to be paid to the labour community is also uniform as it is approved by the state Labour Department.... The committee noted that the basic cost of machinery and equipment manufactured by reputed concerns is generally uniform throughout the State.... The variation in the fuel charges within the states does not show wide variations. As observed from the rates quoted by cement and steel manufacturers for supplies made to various units of Karnataka Land Army Corporation (K.L.A.C.) in the State, does not vary significantly.... In the background of what is stated above, the S.R. Committee came to a unanimous conclusion, that the schedule of rates recommended by it, should be uniform throughout the State. Accordingly the S.R. Committee recommend that the schedule of rates proposed by it, should be made applicable to all Water Resource Projects undertaken in the State and the Water Resources Department should have one S.R. for the entire State." (SRC, 2003, p.28-29).

The SRC also condemns the tendency to incorporate any "New items" in the SoR "without the approval of the Competent Authority and without concurrence from the Government" (SRC, 2003, p.28). Thus, contrary to what would follow from our discussion on variations, the leading philosophy guiding formulation of SoRs is to assume away variations and centralise all decisions about fixing of rates and their revision.

There is an urgent need for a change in the mindset of those formulating the SoRs. Not only that the entire process of arriving at these rates needs to be made much more transparent and participatory. The process of making and revising SoRs is entirely shrouded in mystery. The SoRs never come out in the open about how the rates for different works are arrived at. The whole process is a highly centralised departmental affair. The leading philosophy behind centralisation is explained as follows:

"The system of each circle preparing and issuing Schedule of Rates is likely to result in non-uniform item rates for similar work items in spite of adoption of common standard data and formats for preparation of SR if the material rates / capital cost of machinery and other related basic data differ from circle to circle due to each circle collecting the basic data independently. In view of extensive mechanization and standardization of data, for preparing data rates for work item, rates to be included in

the Schedule of Rates can be common to all circles in the Department / Corporation. Therefore, the preparation and issue of Schedule of Rates shall be centralised under each Department / Corporation to ensure uniformity in rates for similar works in all circles under the Department / Corporation" (GoK Guidelines, 2003).

The SoRs prescribe a "Competent Authority" (usually an Executive Engineer) who can effect a change in the SoR. This black box of SoR preparation and change should be opened up and the process should be made truly participatory. A very detailed database on different conditions and corresponding productivity norms should be drawn up at each district and even block levels. Detailed time and motion studies of how much labour time is required to complete one task in different strata should be carried out. The only way to correct the current injustice is to make the SoR as specific to each work location as possible. Even at present, the district administration usually prepares Collector's Task Rates specific to each district. But the problem is that these rates do not cover many activities and the process of fixing these rates is far from transparent or participatory.

It is heartening to note that the official NREGA Guidelines prescribe that "the Programme Officer, the District Programme Coordinator and the State Government shall keep a watch on the average wages earned under a task-based system. If necessary, the schedule of rates may be revised to ensure that the earnings are near the wage rate. The district-wise average wage earned on a task basis and paid to men and women shall also be brought to the notice of the State Council every year". The Guidelines also provide that "norms for measurement of work have to be evolved by the States, and the wage norms for piece-rate work listed in the 'Schedule of Rates' should be updated in advance of the implementation of the Employment Guarantee Scheme. The factors underlying this should include:

1. ensure that all tasks/works are identified clearly and that nothing remains invisible and underpaid in piece-rate work.
2. delineate tasks properly and carefully and to fix rates separately to the extent possible. Each such task should be specified and defined properly, and the clubbing/bundling of separable tasks (e.g. digging and lifting) should be avoided.
3. devise productivity norms for all the tasks listed under piece-rate works for the different local conditions of soil, slope and geology types in such a way that normal work for seven hours results in earnings at least equal to the minimum wage.
4. devise measurement norms (individual versus collective), reduce time lag between execution and measurement, etc. in order to reduce corruption and underpayment".

It is also said that “the State Governments should undertake comprehensive work, time and motion studies. These studies will observe outturn and fix rates after detailed location-specific observations. This implies that productivity norms must follow possible outturn under different geo-morphological and climatic conditions, across and within Districts. This is of particular significance in areas with a high degree of location specificity and variability in the soil, slope and geological conditions and seasonal variation. Therefore, a matrix of rates for the same task needs to be drawn up that follows ecological rather than administrative boundaries. Based on these studies, separate Schedules of Rates should be prepared for each District, to be called ‘District Schedule of Rates’ (DSR). The DSR may also have further disaggregation within the District, e.g. separate Schedules of Rates for different geographical areas. These rates with standard designs should be proactively disclosed and widely publicized. In particular, the District Schedule of Rates should be posted at worksites in the vernacular, in a manner that is legible and comprehensible to labourers using the simple terminology of ‘people’s estimates’. The communication exercise in NREGA should include wide publicity of such estimates.”

Ideally, a Working Group should be set up in each district to carry out this exercise. This Group should include Gram and Zila Panchayat representatives, local NGOs, independent professionals and government officials and engineers. The role of this Group should not only be to prepare and revise District SoRs but also to arrange for the dissemination of these rates in Gram Sabha meetings across the district. It is only through such efforts that the black box of the SoRs can be opened up and a check be placed on what can be a major potential source of corruption in NREGA.

References

1. GoB (2005): *Schedule of Rates*, Vol. 1 & II, Bhawan Nirman Evam Awas Vibhag, South Bihar Circle, Patna Division, Government of Bihar, Patna
2. GoC (2004): *Nirman Karya Hetu Dar Anusoochi*, Grameen Yantriki Sewa, Panchayat Evam Grameen Vikas Vibhag, Government of Chhatisgarh, Raipur
3. GoJ (2004): *Schedule of Rates for South Chhotanagpur Division*, Public Works Department, Government of Jharkhand, Hazaribagh
4. GoJ (2005): *Schedule of Rates for North Chhotanagpur Division*, Public Works Department, Government of Jharkhand, Hazaribagh
5. GoK (2004): *Schedule of Rates*, Water Resources Department, Government of Karnataka, Bangalore
6. GoM (2001): *Schedule of Rates for the Year 2000-01*, Maharashtra Jeevan Pradhikaran, Government of Maharashtra, Mumbai
7. GoMP (2003): *Unified Schedule of Rates*, Water Resources Department, Government of Madhya Pradesh, Bhopal

8. GoMP (2003a): *Current Schedule of Rates for Rural Engineering Service*, Rural Development Department, Government of Madhya Pradesh, Bhopal
9. GoR (2004): *Zilla Stariya Dar Anusoochi, Grameen Karya Nirdeshika*, Zilla Parishad, Bundi
10. GoWB (2005): *Revised Schedule for Earthwork and Other Related Works*, Office of the District Magistrate, Purulia

17 | Double Entry Accounting for Watershed Works

The distinguishing feature of Total Watershed Planning (TWP) is its participatory approach, which makes it essentially a movement for people's empowerment. While the community regains control in the planning and management of resources, it should also be empowered to manage its funds in a responsible manner. A simple, efficient and fool-proof *accounts system* is, therefore, crucial for the success of a watershed programme. It is normally believed that the double entry system of accounts is extremely difficult for non-experts to understand and operate. However, we have devised an extremely simple method of teaching the system. In our experience over the last ten years of using this module, even among village level functionaries, we have found an excellent response.

This module presents such a system which can easily be adopted even by a village watershed committee operating at the grass-roots level. The detailed method of recording 8 most common types of transactions is outlined in this module. These transactions cover a large range, from deposit of grants received in the bank, undertaking expenditure on watershed works and maintaining the cash book and ledger.

We have assumed in this chapter that the watershed works undertaken under the NREGA will be under the overall responsibility of a Watershed Committee (WC) of the Gram Panchayat. The WC will receive funds for work from the Panchayat. For watershed works, the WC will operate a bank account known as the "Project Account"

17.1 Withdrawal of Cash from the Project Account by Cheque for Expenditure on Watershed Development Activities

Example: WC made a withdrawal of Rs. 9000 by cheque (No. 12301) from the Project Account on 15-12-06 to be spent on watershed development activities.

Making the Voucher

1. Enter the date and voucher number
2. Write description: *Withdrawal by cheque (No. 12301) on 15-12-2006 from the Project Account for watershed development activities.*
3. Write amount in figures as well as words
4. Signature of the WC Secretary

5. After making entries of the transaction in the Cash Book and the Ledger, enter the page numbers of Cash Book and Ledger in the voucher
6. Make a copy of the voucher. Keep the original in the voucher file. The copy can remain in the voucher pad.

■ Supporting Documents to be Attached to the Voucher

- ✓ Counterfoil of the cheque

Cash Book Entry

■ Record this transaction on the Receipts side of the Cash Book

1. On this page, write the date, description, voucher number and amount as entered in the voucher
2. Enter the page number of the Ledger account, **Project Account (Savings Account No. 2101, Regional Rural Bank, Punjapura)**

Ledger Entry

- In the Ledger, a separate page will be allotted for each account.
 1. Open the page for the account **Project Account (Savings Account No. 2101, Regional Rural Bank, Punjapura)**
 2. Enter the date and description as in the voucher
 3. Enter the page number of the Cash Book
 4. Enter the amount on the **Credit** side in the Ledger

17.2 Cash Payment Made for Watershed Development Activities

Example: The WC employed labour for contour trenching on forest land from 10-12-06 to 19-12-06. At a daily wage rate of Rs. 60 per personday for 200 persondays, a total payment of Rs. 12,000 was made to the labourers by muster roll on 20-12-06.

Making the Voucher

1. Enter the date and voucher number
2. Write description: *Payment for labour for contour trenching on forest land from 10-12-06 to 19-12-06, at a daily wage rate of Rs. 60 per personday for 200 persondays*
3. Write amount in figures as well as words

4. Signature of the WC Secretary
5. After making entries of the transaction in the Cash Book and the Ledger, enter the page numbers of Cash Book and Ledger in the voucher
6. Make a copy of the voucher. Keep the original in the voucher file. The copy can remain in the voucher pad.

Supporting Documents to be Attached to the Voucher

- ✓ Muster roll

Cash Book Entry

■ Record these transactions on the Payments side of the Cash Book

1. On this page, write the date, description, voucher number and amount as entered in the voucher
2. Enter the page number of the Ledger account, **Watershed Treatment Works**

Ledger Entry

- In the Ledger, a separate page will be allotted for each account.
 1. Open the page for the account **Watershed Treatment Works**
 2. Separate entries should be made for each example given above
 3. Enter the date and description as in the voucher
 4. Enter the page number of the Cash book
 5. Enter the amount on the **Debit** side in the Ledger

17.3 Salary Payment to WC Secretary

Example: The WC paid the salary of Rs. 1000 in cash to the WC Secretary for the month of December, 2006 from its administrative expenses fund.

Making the Voucher

1. Enter the date and voucher number
2. Write description: *Administrative Expenses: Salary of the WC Secretary for December, 2006.*
3. Write amount in figures as well as words
4. Signature of the WC Secretary
5. After making entries of the transaction in the Cash Book and the Ledger, enter the page numbers of Cash Book and Ledger in the voucher

6. Make a copy of the voucher. Keep the original in the voucher file. The copy can remain in the voucher pad.

Cash Book Entry

■ Record these transactions on the Payments side of the Cash Book

1. On this page, write the date, description, voucher number and amount as entered in the voucher
2. Enter the page number of the Ledger account, **Salary of WC Secretary**

Ledger Entry

■ In the Ledger, a separate page will be allotted for each account.

1. Open the page for the account **Salary of WC Secretary**
2. Enter the date and description as in the voucher
3. Enter the page number of the Cash book
4. Enter the amount on the **Debit** side in the Ledger

17.4 Grants Received from the Panchayat

Example: On 6-12-2006, the WC received a grant of Rs. 400,000 from the Panchayat for its watershed development activities (Demand Draft No. 45567 of the Bank of India, payable at Dewas, dated 1-12-06)

Phase 1 ■ Receipt of the Draft

Making the Voucher

1. Enter the date and voucher number
2. Write description: *Received grant from Panchayat for watershed works by Demand Draft No. 45567 of the Bank of India, payable at Dewas, dated 1-12-2006*
3. Write amount in figures as well as words
4. Signature of the WC Secretary
5. After making entries of the transaction in the Cash Book and the Ledger, enter the page numbers of Cash Book and Ledger in the voucher
6. Make a copy of the voucher. Keep the original in the voucher file. The copy can remain in the voucher pad.

■ Supporting Documents to be Attached to the Voucher

- ✓ Sanction Letter
- ✓ Letter of Release of Instalment

Cash Book Entry

■ Record this transaction on the Receipts side of the Cash Book.

1. On this page, write the date, description, voucher number and amount as entered in the voucher
2. Enter the page number of the Ledger account, **Grants Received from Panchayat**.

Ledger Entry

- In the Ledger, a separate page will be allotted for each account.
 1. Open a new account called **Grants Received from Panchayat**
 2. Enter the date and description as in the voucher
 3. Enter the page number of the Cash Book
 4. Enter the amount on the **Credit** side of the Ledger

Phase 2 ■ Deposit of Draft in the Bank

Making the Voucher

1. Enter the date and voucher number
2. Write description: *Deposit of grant received from Panchayat for watershed works by Demand Draft No. 45567 of the Bank of India, payable at Dewas, dated 1-12-2006 in the Project Account (Savings Account No.2101) in Regional Rural Bank, Punjapura*
3. Write amount in figures as well as words
4. Signature of the WC Secretary
5. After making entries of the transaction in the Cash Book and the Ledger, enter the page numbers of Cash Book and Ledger in the voucher
6. Make a copy of the voucher. Keep the original in the voucher file. The copy can remain in the voucher pad.

Deposit the draft into the bank (Project Account)

■ Supporting Documents to be Attached to the Voucher

- ✓ Pay-in slip from the bank

Cash Book Entry

- **Record this transaction on the Payments side of the Cash Book**
 1. On this page, write the date, description, voucher number and amount as entered in the voucher
 2. Enter the page number of the Ledger account, **Project Account (Savings Account No. 2101, Regional Rural Bank, Punjabura)**.

Ledger Entry

- In the Ledger, a separate page will be allotted for each account.
 1. Open a new account called **Project Account (Savings Account No. 2101, Regional Rural Bank, Punjabura)**
 2. Enter the date and description as in the voucher
 3. Enter the page number of the Cash Book
 4. Enter the amount on the **Debit** side in the Ledger

17.5 Cheque Payment Made for Watershed Development Activities

Example 1: Plastic (LDPE) sheets were purchased from K.S. Plastic Traders, Indore for providing diaphragm for underground dykes. The payment of Rs. 5000 for this was made through cheque (No. 12302, dated 15-12-06).

Example 2: 100 metres of wire mesh (at Rs. 90 per metre) for construction of gabion structure was purchased from Mohan Wires, Dewas. The payment of Rs. 9000 for this was made through cheque (No. 12303, dated 20--12-06).

Example 3: For development of fodder banks in the village, the WC purchased grass seeds worth Rs. 4000 from Swadeshi Agro, Indore. The payment for this was made by cheque (No. 12304, dated 20-12-06).

Making the Voucher

Make separate vouchers for all three transactions.

1. Enter the date and voucher number
2. Write description:
 - ❖ Example 1: Payment to K.S. Plastic Traders, Indore for the purchase of plastic (LDPE) sheets for underground dykes. Payment made by Project Account cheque No. 12302, dated 15-12-06

* Example 2: Payment to Mohan Wires, Dewas, for 100 metres of wire mesh (at Rs. 90 per metre) for construction of gabion structure. Payment made by Project Account cheque No. 12303, dated 20-12-06

* Example 3: Payment to Swadeshi Agro, Indore, for purchase of grass seeds. Payment made by Project Account cheque No. 12304, dated 30-12-06

3. Write amount in figures as well as words
4. Signature of the WC Secretary
5. After making entries of the transaction in the Cash Book and the Ledger, enter the page numbers of Cash Book and Ledger in the voucher
6. Make a copy of the voucher. Keep the original in the voucher file. The copy can remain in the voucher pad.

Supporting Documents to be Attached to the Voucher

- ✓ Example 1: Bill & receipt from K.S. Plastic Traders, Indore for the purchase of plastic (LDPE) sheets.
- ✓ Example 2: Bill & receipt from Mohan Wires, Dewas, for 100 metres of wire mesh.
- ✓ Example 3: Bill & receipt from Swadeshi Agro, Indore, for purchase of grass seeds.

Cash Book Entry

■ Record these transactions on the Payments side of the Cash Book

1. On this page, write the date, description, voucher number and amount as entered in the voucher
2. Enter the page number of the Ledger account, **Watershed Treatment Works**

■ Since this transaction did not involve any cash payment, they should be recorded separately on the Receipts side of the Cash Book also

1. On this page, write the date, description, voucher number and amount as entered in the voucher
2. Enter the page number of the Ledger account, **Project Account (Savings Account No. 2101, Regional Rural Bank, Punjapura)**

Ledger Entry

■ In the Ledger, a separate page will be allotted for each account.

1. Open the page for the account **Watershed Treatment Works**
2. Separate entries should be made for each example given above

3. Enter the date and description as in the voucher
 4. Enter the page number of the Cash Book
 5. Enter the amount on the **Debit** side in the Ledger
- Since these transactions did not involve any cash payment, they should be recorded under Project Account (Savings Account No. 2101, Regional Rural Bank, Punjapura) also.
1. Open the page for the account **Project Account (Savings Account No. 2101, Regional Rural Bank, Punjapura)**
 2. Separate entries should be made for each example given above
 3. Enter the date and description as in the voucher
 4. Enter the page number of the Cash Book
 5. Enter the amount on the **Credit** side in the Ledger.

17.6 Interest on Project Account

Example: WC received Rs. 500 on its Project Account as interest on 31-3-2006
--

Making the Voucher

1. Enter the date and voucher number
2. Write description: *Interest received on Project Account (Savings Account No. 2101, Regional Rural Bank, Punjapura)*
3. Write amount in figures as well as words
4. Signature of the WC Secretary
5. After making entries of the transaction in the Cash Book and the Ledger, enter the page numbers of Cash Book and Ledger in the voucher
6. Make a copy of the voucher. Keep the original in the voucher file. The copy can remain in the voucher pad.

Supporting Documents to be Attached to the Voucher

- ✓ Photocopy of the page of the bank passbook in which the interest entry has been made

Cash Book Entry

■ Record this transaction on the Receipts side of the Cash Book

1. On this page, write the date, description, voucher number and amount as entered in the voucher

2. Enter the page number of the Ledger account, **Interest Received on Project Account**.

■ Since this amount has not been received in cash and has been deposited in the bank directly, this transaction should be recorded on the Payments side of the Cash Book also

1. On this page, write the date, description, voucher number and amount as entered in the voucher
2. Enter the page number of the Ledger account, **Project Account (Savings Account No. 2101, Regional Rural Bank, Punjabura)**

Ledger Entry

■ In the Ledger, a separate page will be allotted for each account.

1. Open a new account called **Interest Received on Project Account**
2. Enter the date and description as in the voucher
3. Enter the page number of the Cash Book
4. Enter the amount on the **Credit** side in the Ledger

■ Since this amount has not been received in cash but has been deposited in the bank directly, this transaction should be recorded in the Ledger under the Project Account also

1. Open the page for the account **Project Account (Savings Account No. 2101, Regional Rural Bank, Punjabura)**
2. Enter the date and description as in the voucher
3. Enter the page number of the Cash Book
4. Enter the amount on the **Debit** side in the Ledger

17.7 Calculating Balances in the Cash Book

Cash Book balances are calculated at the end of each page as well as at the end of the month ■ At the end of each page

Example: On the **receipts** side of the page the following entries have been made:

1. 50 2. 50

On the **payments** side of the page the following entries have been made:

1. 10 2. 20 3. 30 4. 20

1. Leave three lines at the bottom of every page empty

2. Calculate the total on the **receipts** side = Rs. 100
3. Calculate the total on the **payments** side = Rs. 80
4. Write the balance ($100-80=20$) on the **payments** side. Write description: *Balance carried forward to next page*
5. In the date column of the row where balance is being entered, enter the date of the last transaction on the page.
6. Write the grand totals on each side (=Rs. 100).
7. Write description in the next page, on the **receipts** side: *Balance brought down from previous page* and enter the balance (=Rs. 20).
8. In the date column of the row where balance is being entered, enter the same date as that of the balance row in the previous page.

■ At the end of each month

Example: On the **receipts** side of the page the following entries have been made:

1. 1500 2. 200

On the **payments** side of the page the following entries have been made:

1. 300 2. 50 3. 150 4. 500

1. Leave three lines at the bottom of every page empty
2. Calculate the total on the **receipts** side = Rs. 1700
3. Calculate the total on the **payments** side = Rs. 1000
4. Write the balance ($1700-1000=700$) on the **payments** side. Write description: *Balance at the end of this month carried forward to next page*
5. In the date column of the row where balance is being entered, enter the date of the last transaction of the month.
6. Write the grand totals on each side (=Rs. 1700).
7. Write description in the next page, on the **receipts** side: *Balance at the beginning of this month brought down from previous page* and enter the balance (=Rs. 700).
8. In the date column of the row where balance is being entered, enter the first date of the next month.

17.8 Calculating Ledger Balances

Ledger balances are calculated at the end of each page as well as at the end of the financial year

- At the end of each page

Example: On the **debit** side of a page in a Ledger account the following entries have been made:

1. 10 2. 20 3. 30 4. 40

On the **credit** side of the page in the account the following entries have been made:

1. 30 2. 50

1. Leave three lines at the bottom of every page empty
2. Calculate the total on the **debit** side = Rs. 100
3. Calculate the total on the **credit** side = Rs. 80
4. In this page, the debit side shows a higher figure than credit side. Write the balance (100-80=20) on the **credit** side. Write description: *Debit balance carried forward to page . . . of the account*
5. In the date column of the row where balance is being entered, enter the date of the last transaction on the page.
6. Write the grand totals on the **debit** and **credit** side of the account (=Rs. 100).
7. Write description in the next page, on the **debit** side: *Debit Balance brought down from page . . . of the account* and enter the balance (=Rs. 20).
8. In the date column of the row where balance is being entered, enter the date of the last transaction on the previous page.

■ At the end of the financial year

Example 1: On the **debit** column of the **Project Account**, the following entries have been made till the end of financial year 2006-07:

1. 1500 2. 200

On the **credit** side of the page the following entries have been made:

1. 300 2. 50 3. 150 4. 500

1. Leave three lines at the bottom of every page empty
2. Calculate the total on the **debit** side = Rs. 1700
3. Calculate the total on the **credit** side = Rs. 1000
4. In this page, the debit side shows a higher figure than credit side. Write the balance (1700-1000=700) on the **credit** side. Write description: *Debit Balance at the end of the financial year*
5. In the date column of the row where balance is being entered, enter the last date of the financial year.
6. Write the grand totals on each side (=Rs. 1700).

Example 2: On the **debit** column of the account **Watershed Development Works**, the following entries have been made till the end of financial year 1996-97:

1. 1500 2. 200 3. 800 4. 1000 5. 150 6. 450

On the **credit** side of the page the no entries have been made

1. Leave three lines at the bottom of every page empty
2. Calculate the total on the **debit** side = Rs. 4100
3. Calculate the total on the **credit** side = 0
4. In this page, the debit side shows a higher figure than credit side. Write the balance ($4100-0=4100$) on the **credit** side. Write description: *Debit Balance at the end of the financial year*
5. In the date column of the row where balance is being entered, enter the last date of the financial year.

Write the grand totals on each side (=Rs. 4100).

17.9 Accounts Transactions at a Glance

Trans-action No.	Transaction Type	Cash Book		Ledger		
		Receipts	Payments	Name of Account	Debit	Credit
1.	Withdrawal of Cash from Project Bank Account	✓		Project Account		✓
2.	Cash Payment for Watershed Treatment Works		✓	Watershed Treatment Works	✓	
3.	Payment of Salary to WC Secretary		✓	Salary of WC Secretary	✓	
4	Grant Received from Panchayat					
	• Phase 1: Receipt of the Draft	✓		Grants Received from Panchayat		✓
	• Phase 2: Deposit of the Draft		✓	Project Account	✓	
5	Payments for Watershed Works by Cheque		✓	Watershed Treatment Works	✓	
		✓		Project Account		✓
6.	Interest Earned on Project Account	✓		Interest Received on Project Account		✓
			✓	Project Account	✓	

All Non-Cash Transactions Must be Entered on Both Sides

Main Principles of the Double Entry Accounting System

1. The Sequence of Making Entries

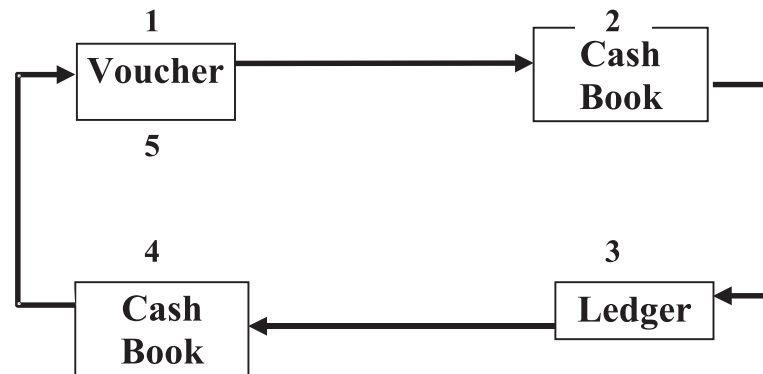

- First Fill Up the Voucher
- Then Enter the Cash Book
- Then Enter the Ledger
- Make Remaining Entries in the Cash Book
- Finally complete the Voucher

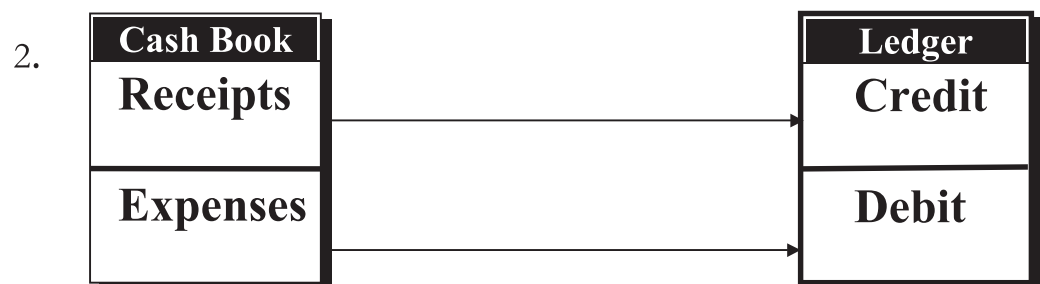

- Transactions which are entered in the Cash Book on the Receipts side must be entered in the Ledger on the Credit side
- Transactions which are entered in the Cash Book on the Expenses side must be entered in the Ledger on the Debit side

18 | Annexures

1. Districts Covered by NREGA (June 30, 2006)

No.	State	District
1	Andhra Pradesh	Adilabad
2		Anantapur
3		Chittoor
4		Cuddapah
5		Karimnagar
6		Khammam
7		Mahbubnagar
8		Medak
9		Nalgonda
10		Nizamabad
11		Rangareddi
12		Vizianagaram
13		Warangal
14	Arunachal Pradesh	Upper Subansiri
15	Assam	Bongaigaon
16		Dhemaji
17		Goalpara
18		Karbi Anglong
19		Kokrajhar
20		Lakhimpur
21		North Cachar Hills
22	Bihar	Araria
23		Aurangabad
24		Bhojpur
25		Darbhanga
26		Gaya
27		Gopalganj
28		Jamui
29		Jehanabad

No.	State	District
30		Kaimur (Bhabua)
31		Katihar
32		Kishanganj
33		Lakhisarai
34		Madhubani
35		Munger
36		Muzaffarpur
37		Nalanda
38		Nawada
39		Patna
40		Purnia
41		Rohtas
42		Samastipur
43		Sheohar
44		Supaul
45		Vaishali
46	Chattisgarh	Bastar
47		Bilaspur
48		Dantewada
49		Dhamtari
50		Jashpur
51		Kanker
52		Kawardha
53		Koriya
54		Raigarh
55		Rajnandagon
56		Surguja
57	Gujarat	Banas Kantha
58		Dang
59		Dohad
60		Narmada
61		Panch Mahals
62		Sabar Kantha
63	Haryana	Mahendragarh
64		Sirsa

No.	State	District
65	Himachal Pradesh	Chamba
66		Sirmaur
67	Jammu And Kashmir	Doda
68		Kupwara
69		Poonch
70	Jharkhand	Bokaro
71		Chatra
72		Dhanbad
73		Dumka
74		Garhwa
75		Giridih
76		Godda
77		Gumla
78		Hazaribagh
79		Jamtara
80		Koderma
81		Latehar
82		Lohardaga
83		Pakur
84		Palamu
85		Ranchi
86		Sahebganj
87		Saraikela Kharsawan
88		Simdega
89		West Singhbhum
90	Karnataka	Bidar
91		Chitradurga
92		Davangere
93		Gulbarga
94		Raichur
95	Kerala	Palakkad
96		Wayanad
97	Madhya Pradesh	Balaghat
98		Barwani
99		Betul

No.	State	District
100		Chhatarpur
101		Dhar
102		Dindori
103		East Nimar
104		Jhabua
105		Khargone
106		Mandla
107		Satna
108		Seoni
109		Shahdol
110		Sheopur
111		Shivpuri
112		Sidhi
113		Tikamgarh
114		Umaria
115	Maharashtra	Ahmednagar
116		Amravati
117		Aurangabad
118		Bhandara
119		Chandrapur
120		Dhule
121		Gadchiroli
122		Gondia
123		Hingoli
124		Nanded
125		Nandurbar
126		Yavatmal
127	Manipur	Tamenglong
128	Meghalaya	South Garo Hills
129		West Garo Hills
130	Mizoram	Lungtalai
131		Saiha
132	Nagaland	Mon
133	Orissa	Balangir
134		Boudh

No.	State	District
135		Deogarh
136		Dhenkanal
137		Gajapati
138		Ganjam
139		Jharsuguda
140		Kalahandi
141		Kandhamal
142		Kendujhar
143		Koraput
144		Malkangiri
145		Mayurbhanj
146		Nabarangapur
147		Nuapada
148		Rayagada
149		Sambalpur
150		Sonepur
151		Sundargarh
152	Punjab	Hoshiarpur
153	Rajasthan	Banswara
154		Dungarpur
155		Jhalawar
156		Karauli
157		Sirohi
158		Udaipur
159	Sikkim	North District
160	Tamil Nadu	Cuddalore
161		Dindigul
162		Nagapattinam
163		Sivaganga
164		Tiruvannamalai
165		Villupuram
166	Tripura	Dhalai
167	Uttar Pradesh	Azamgarh
168		Banda
169		Barabanki

No.	State	District
170		Chandauli
171		Chitrakoot
172		Fatehpur
173		Gorakhpur
174		Hamirpur
175		Hardoi
176		Jalaun
177		Jaunpur
178		Kaushambi
179		Kheri
180		Kushi Nagar
181		Lalitpur
182		Mahoba
183		Mirzapur
184		Pratapgarh
185		Rae Bareli
186		Sitapur
187		Sonbhadra
188		Unnao
189	Uttranchal	Chamoli
190		Champawat
191		Tehri Garhwal
192	West Bengal	24 Paraganas South
193		Bankura
194		Birbhum
195		Dinajpur Dakshin
196		Dinajpur Uttar
197		Jalpaiguri
198		Maldah
199		Medinipur West
200		Murshidabad
201		Purulia

A.4. Possible Framework for a Gram Rozgar Sevak

Possible responsibilities for the Gram Rozgar Sevak include the following:

1. maintaining all REGS-related documents at the Gram Panchayat level, including prescribed accounts, and ensuring that these documents are conveniently available for public scrutiny;
2. ensuring that the norms of transparency and “pro-active disclosure” are observed in the Gram Panchayat;
3. overseeing the process of registration, distribution of job cards, provision of dated receipts against job applications, etc.;
4. ensuring the smooth and timely flow of information within the Gram Panchayat, as well as between the Gram Panchayat and the Programme Officer (including weekly provision of information on job applications to the Programme Officer);
5. overseeing job applications, allocation of work, payment of wages, payment of unemployment allowance and other activities held on the weekly “employment guarantee day” at the Gram Panchayat level, and being personally present on that day;
6. ensuring that the requisite Gram Sabha meetings and social audits are held;
7. providing any REGS-related information or advice that may be required by REGS workers or other residents of the Gram Panchayat;
8. any other duties that may be prescribed by the State Employment Guarantee Council.

If Gram Rozgar Sevaks are appointed in each Gram Panchayat, it is suggested that the State Employment Guarantee Council should determine their job description, minimum qualifications, and the process through which they should be appointed and evaluated. The salaries of Gram Rozgar Sevaks should be met from the funds provided by the Central Government for administrative expenses, possibly supplemented with additional contributions from the State Government.

JOB/EMPLOYMENT RECORD

Demand for work Record

S.No.	Date of submission of application for seeking employment	Date from which employment is needed	No. of days

Details of Employment Provided

S. No	Month & Year	Name of Family Member to whom Employment Provided	No. of Days and Date for which Employment Provided		Details of Work on which Employment Provided	Muster Roll Number by which wages paid	Signature of Authorised Officer
			Date	No. of Days			
			From	To			

Note:

1. No Row will be left blank in any case.
2. Monthwise totals will be done at the end of Month for number of days of employment provided.
3. Details will be entered separately for separate family member.
4. Accordingly when wage employment of 100 days have been provided to the household, it has to be entered in the next row in red ink.
5. The entries of the next month should immediately start from the next row giving total of previous month.
6. There should be 20 rows available for entries on one page. There must be at least 5 such pages having 20 rows for making entries during the 5 years.

B.3. Proforma for Muster Roll

SI No. of Muster Roll
(Every Muster Roll must have distinct Number)

SUGGESTED PROFORMA FOR MUSTER ROLL

Name of work:

Financial Approval Number:

Date:

Period of Attendance:

Month:

Date:

Sl. No	Name, Name of Father/ Husband,	Job card No.	Village and G.P.	Category Skilled/ Unskilled	1	2	3	4	5	6	7	8	9	10	11	12	13	14	15	31
1					16	17	18	19	20	21	22	23	24	25	26	27	28	29	30	31
2																				
3																				
4																				
5																				
6																				
7																				
8																				
9																				
10																				
	Total no. of:		Daily Total																	
	Workers		Signature of person taking attendance																	
	Women:		Signature of Inspecting Authority																	
	Men																			
	SC/ST																			
	OBC																			
	Others																			

Amount Due Rs. (Rupees).....in words)

Actual Amount paid Rs. (Rupees).....in words)

Dated

Approved by
Sarpanch/Programme officer/Authorised officer

B.7. Proforma for Registration Application Register

No.	Name of Applicant	Date of receipt of application/ request for registration	No. and date of job card issued	Reasons, if job card not issued and any other remarks

B.8. Proforma of Job Card Register

INDEX OF JOB CARD REGISTER

No.	Job Card No.	Name of Registered persons in the household	Page No.

Page No.:

PROFORMA OF PAGES IN THE JOB CARD REGISTER

1. Registration Number of the Household:
2. Name(s) of the Applicant
3. SC/ST/IAY/LR beneficiary
4. Details of the applicants of the Household willing to work

S.No.	Name	Father's/Husband's Name	Male/ Female	Age on Date of Registration	P.O/Bank A/c No. (if any)	P.O/Bank Code

4. Address

5. Date of Registration:

**Joint Photograph of
Household duly attested
by Sarpanch and
Panchayat Secretary**

**Signature/Thumb
impressions of applicants**

**Seal & Signature of
Registering Authority**

B.9. Employment Register at Gram Panchayat Level

EMPLOYMENT REGISTER AT GRAM PANCHAYAT LEVEL

INDEX			
S.No.	Job Card No.	Name of Registered persons in the household	Page No.

PROFORMA OF PAGES

Page No.:

1. Registration Number of the Household :
2. Requested period of employment

Sl. No.	Name of applicant	Month and date from which Employment Requested	No. of days	Preference for place

3. Period and work on which employment offered

Sl. No.	Name of applicant	Month and date from which Employment Offered	No. of days	Name of work

4. Period and work on which employment given

Sl. No.	Name of applicant	Month and date from which employment availed	No. of days	Name of work	Muster roll No. vide which employment

Page no.....

PROFORMA FOR ASSET REGISTER (PAGES)

1. Name of Work
2. Nature of work
3. Scope of work
4. Location of work
Village
Gram Panchayat
Block
District
5. No. and date of sanction
6. Whether included in five year Perspective Plan Yes/No
7. Whether work approved in Annual Plan by DP Yes/No
8. Estimated cost Rs.
9. Estimated completion time
10. Expenditure incurred (in Rs.)

Labour unskilled	Labour semi-skilled	Labour skilled	Material	Contingency	Total

11. Employment generated

	Persondays	Total No. of persons given work	No. of persons on work	
			Highest	Lowest
Unskilled				
Semiskilled				
Skilled				

12. Distinct Numbers of muster rolls used
13. Date of start of work
14. Date of completion
15. Whether local vigilance committee formed. Yes/No

B.13. Details of Work to be Displayed at the Work Site

DETAILS OF WORK

(To be displayed at site of work)

Name of Work :
 Details : Vill./G.P:
 Project (Yojna):
 Executing Agency: Year :
 Sanctioned Amount : Material Labour
 Date of Start : Completion Period:

MATERIAL REQUIRED			Technical Specifications of Work
Name of Material	Qty. with local Unit	Rate per unit	
Labour Required			

Documents available at site :

For further Information contact :



Founded by a group of 10 professionals in 1990, Samaj Pragati Sahayog (SPS) is one of India's leading grass-roots organisations working on water and livelihood security in the central, tribal hinterlands of the country. It is headquartered in a small tribal village in the Dewas district of Madhya Pradesh. Through the Baba Amte Centre for People's Empowerment, SPS has transmitted the learnings of its work to more than 500 civil society organisations in 100 of the most backward districts of India.

Samaj Pragati Sahayog
Bagli, District Dewas, Madhya Pradesh 455227
Telephone and Fax: 07271-275757, 275550, 275500
email: core@samprag.org; samprag@gmail.com